

ROLLWAY®



ROLLWAY® BEARINGS TECHNICAL NOTES

REGAL®

TECHNICAL NOTEBOOK

ROLLWAY®

INTRODUCTION & TABLE OF CONTENTS

Rollway is a brand of Regal Beloit Corporation (NYSE: RBC), a multinational active in electric motors, electrical motion controls, power generation and transmission components.

Visit the website: www.regalbeloit.com

There are over 5000 different types of Rollway® standard ball bearings, served by a global distribution network.

This catalogue is a quick reference guide which covers topics for bearing selection, installation, maintenance and operation. The technical data provided herein are subject for revision from time to time, depending on design and specification changes.

In case of critical applications or additional required information, the Rollway bearing application engineering department should be contacted.

Rollway bearings are produced in first class manufacturing facilities according to the latest ISO standards. Continuous improvements are implemented to keep pace with the technological developments of the different industries.



















The load ratings are determined based on the ISO 281:2015 standard, but taking into account the latest improvements of manufacturing, design and material specifications.

All possible efforts have been put into the compilation of this catalogue to be without errors, but in the unlikely event that a mistake passed unnoticed, Regal cannot be held responsible for any consequential loss or damage related to it.



Table of Contents

PRODUCTS

Deep Groove Ball Bearing	Pages 5-34	
Self-Aligning Ball Bearing	Pages 35-44	
Angular Contact Ball Bearing	Pages 45-60	 
Cylindrical Roller Bearing Single Double Row	Pages 61-102	 
Cylindrical Roller Bearing Full Complements Single Double Row	Pages 103-118	 
Spherical Roller Bearing	Pages 119-138	
Spherical Roller Bearing Vibrating Screen	Pages 139-142	
Tapered Roller Bearing	Pages 143-154	
Thrust Ball Bearing Single Double acting	Pages 155-166	 
Spherical Roller Thrust Bearing	Pages 167-172	
Accessories (Sleeves Nuts Locking Devices)	Pages 173-194	  
Mounted Ball Bearing	Pages 195-256	
Plummer Blocks	Pages 257-288	

Bearing Selection	Pages 292-294
Bearing Life and Load Ratings	Pages 295-305
Limiting Speed	Pages 306
Bearing Materials	Pages 307
Handling of bearings	Pages 308-310
Fits and clearance	Pages 311-312
Shaft and housing fits	Pages 313-322
Tolerances	Pages 333-339
Lubrication	Pages 340-344

Notes

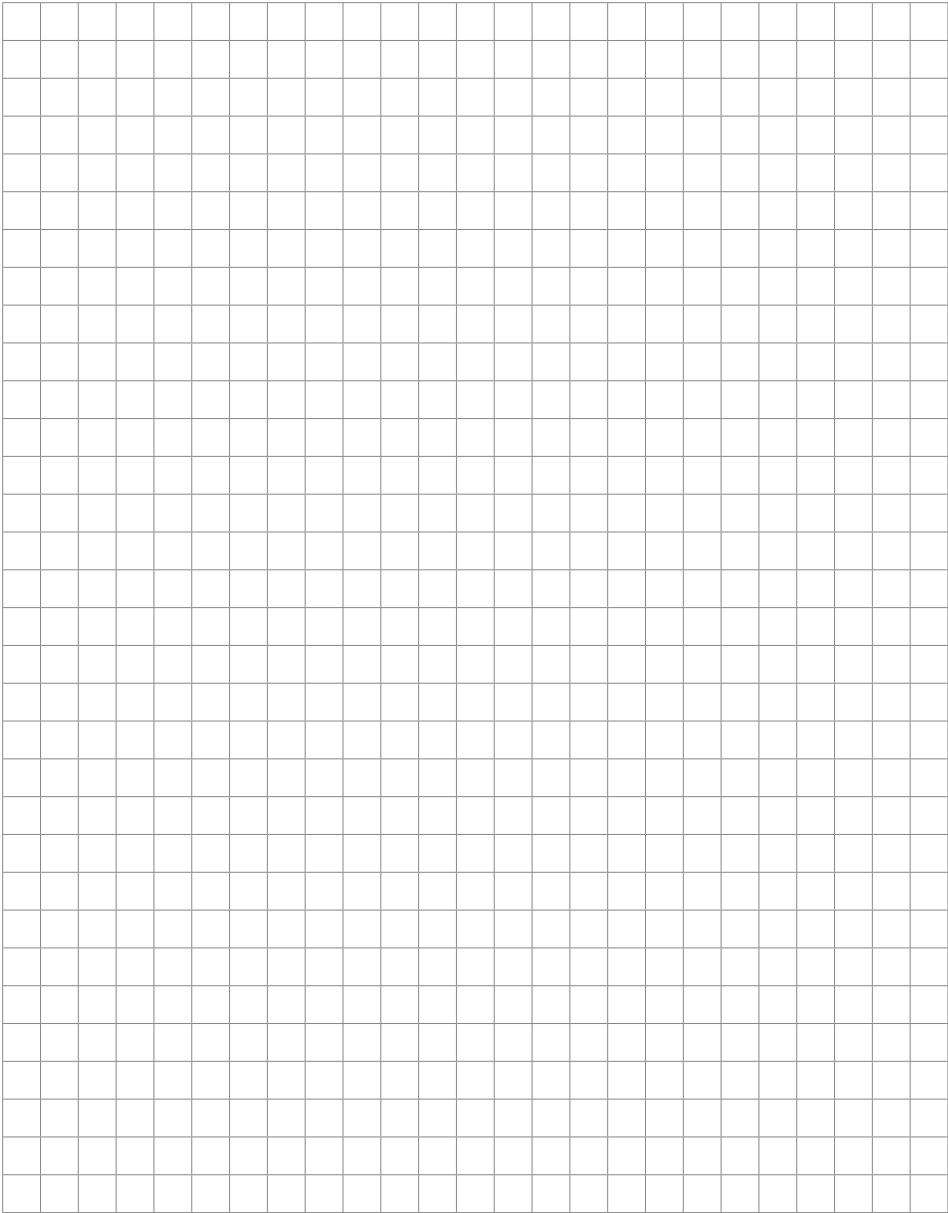

A large empty grid for taking notes, consisting of 25 columns and 35 rows of small squares.

TECHNICAL NOTEBOOK

ROLLWAY®

DEEP GROOVE BALL BEARING



In this section:

	Page
Design Characteristics Applications Angular Misalignment	6
ISO Specification Series Nomenclature	7
Equivalent Load Equations Axial Loading Capacity Shields Seal	8
Lubrication Abutments	9-11
Snap Ring Dimensions	12
Radial Clearance Tables	13-14
Data Tables	15-28

REGAL®

Deep Groove Ball Bearing

DESIGN | CHARACTERISTICS | APPLICATIONS

The single row deep groove ball bearing is the most popular type of rolling bearing. Deep groove ball bearings are non-separable, comparatively rigid radial bearings, their balls are guided in deep radial running grooves. Because the inner and outer raceway radii are only slightly larger than the ball diameter it has considerable axial load carrying capacity in either direction as well as radial loading. They are suitable for high speeds.

Combined loads are accommodated to an optimum degree, in fact at higher speeds they are often better suited to transmit thrust loads than the thrust ball bearing. For these reasons and also economical price, it is the most widely used bearing.

For wet applications, a bearing made of stainless steel is offered with a prefix S. For more info about this bearing, refer to Stainless Steel section.

Deep groove ball bearings are also available with one or two seals 2RS or shields ZZ.

Bearing with a bore size between 3mm and 180mm, dedicated for electric motors, have the suffix EMQ (Electric Motor Quality).

Cages are normally two pieced pressed steel. For higher speeds machined brass cages or reinforced polyamide are used. Polyamide cages are limited on operating temperature to about 120°C maximum.

Deep groove ball bearings with snap ring groove and snap ring in the outer ring enables a simple and space-saving axial location in the housing. Bearings with this feature have the suffix NR added to the designation.



ANGULAR MISALIGNMENT

The following is an approximate guide to the misalignment that can be accommodated in the use of a single row ball bearing:

0.0010 radians

A greater degree of misalignment can sometimes be accommodated if pure radial load is applied, particularly if the misalignment results from occasional peak load, and if the bearing had sufficient radial internal clearance after mounting to avoid excessive stresses.

ISO SPECIFICATIONS

- Dimensions in accordance with ISO 15 (latest version)
- Precision class in accordance with ISO 492 (latest version)
- Radial clearance in accordance with ISO 5753 (latest version)

SERIES

The series 62200 | 62300 | 6400 are not popular items.

Contact Regal Beloit Belgium for more details.

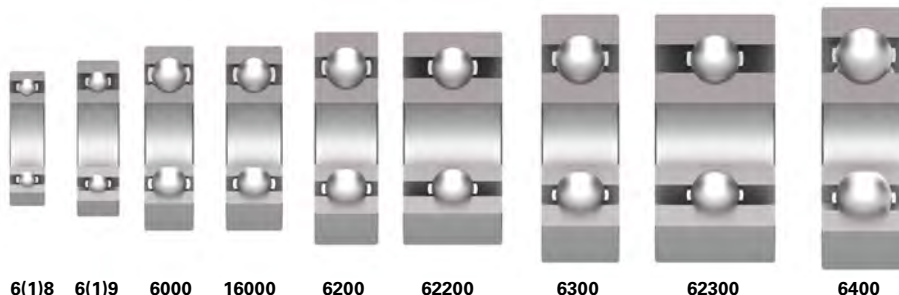

NOMENCLATURE

Prefixes:

S : Stainless steel bearing, sealed and lubricated for life time

CR : Ceramic rolling elements for electric insulation applications

Suffixes:

RS : 1 NBR seal reinforced with the metallic washer

2RS : 2 NBR seals, filled with Lithium base grease. Peak operating temperature is 100°C

Z : 1 steel shield

ZZ : 2 steel shields, filled with Lithium base grease. Peak operating temperature is 120°C

2VS : 2 Fluorine rubber seals, filled with high temperature grease.

Peak operating temperature is 200°C

EMQ : Electric motor quality bearing. Are low noise ,precision bearings

2RS EMQ : Sealed electric motor quality bearing, filled with Polyurea base grease.

Peak operating temperature is 100°C

ZZ EMQ : Shielded electric motor quality bearing, filled with Polyurea base grease.

Peak operating temperature is 120°C

NR : Snap ring groove in the outer ring, including snap ring - (R)

M : Brass cage. Typically for bore size over 100 mm

TN : Polyamide cage

K : Tapered bore

C2 - C4 : Radial clearance class

P0 - P6 : Precision class

V2 - V4 : Noise level class whereas V3 is quieter than V2

Deep Groove Ball Bearing

EQUIVALENT LOAD EQUATIONS

Equivalent dynamic load P_e

$$P_e = XFr + YFa \text{ [Kn]}$$

The factors X and Y depend upon the ratio F_a/C_o . (The relationship of the axial load to the basic static load) the values shown in the table are applicable to bearings mounted with normal fits – shafts machined to j5 or k5 and housings to J6.

Equivalent static load P_o

$$P_o = Fr \quad \text{when} \quad F_a/F_r \leq 0.8 \text{ [KN]}$$

$$P_o = 0.6Fr + 0.5Fa \quad \text{when} \quad F_a/F_r \geq 8 \text{ KN}$$

Calculation factors X and Y for deep groove ball bearings.

Fa/Co	Normal radial clearance					Radial clearance C3					Radial clearance C				
	Fa / Fr ≤ e			Fa / Fr > e		Fa / Fr ≤ e			Fa / Fr > e		Fa / Fr ≤ e			Fa / Fr > e	
	e	X	Y	X	Y	e	X	Y	X	Y	e	X	Y	X	Y
0.025	0.22	1	0	0.56	1.2	0.31	1	0	0.46	1.75	0.4	1	0	0.44	1.12
0.04	0.24	1	0	0.56	1.8	0.33	1	0	0.46	1.62	0.42	1	0	0.44	1.36
0.07	0.27	1	0	0.56	1.6	0.36	1	0	0.46	1.46	0.44	1	0	0.44	1.27
0.13	0.31	1	0	0.56	1.4	0.41	1	0	0.46	1.3	0.48	1	0	0.44	1.16
0.25	0.37	1	0	0.56	1.2	0.46	1	0	0.46	1.14	0.53	1	0	0.44	1.05
0.5	0.44	1	0	0.56	1	0.54	1	0	0.46	1	0.56	1	0	0.44	1

AXIAL LOADING CAPACITY

If deep groove ball bearings are axially loaded, this should generally not exceed 0.5 C_o .

For small bearings and light series the axial load should not exceed 0.25 C_o .

SHIELDS | SEALS



2RS

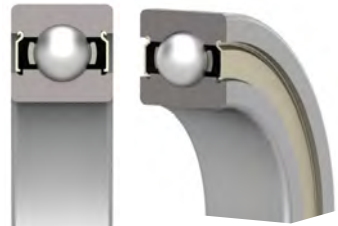

ZZ

The non-contact metallic shields (ZZ) are pre-lubricated with the correct quantity of a lithium base grease which allows operating temperatures of -30°C to $+120^{\circ}\text{C}$.

While the shields makes no contact with the inner ring, small dust particles or moisture can still enter inside the bearing. Shields are suitable for a dry environment with a low or medium dust contamination.

The speed limit are the same than the open version.

The contact seals (RS, 2RS) are made from NBR - Nitril Butadiene Rubber. The rubber withstands operating temperatures of 100°C max. They are reinforced with a metallic washer inside.

The bearings are pre-lubricated with the correct quantity grease.

Sealed bearings have a lower maximum speeds due to the contact between the seal lips and the inner ring. This contact will generate heat which will reduce the speed limit of -20% compared to an open or shielded bearing.

For higher temperature, Fluorine Rubber seals (2VS) are used. Bearings with two Fluorine Rubber seals are pre-lubricated with grease which allows operating temperatures up to 200°C.

LUBRICATION

A variation of lubricants are available for sealed deep groove ball bearings

Standard shielded or sealed bearings are lubricated with lithium based grease, with a fill rate of 30%. The viscosity is 100 ISO VG

EMQ bearings are lubricated with Polyurea grease with a fill rate of 30%.

The viscosity is 100 ISO VG.

Sealed bearings with a high temperature seal 2VS are filled with high temperature grease. Grease type is in accordance with customer needs.

Deep Groove Ball Bearing

ABUTMENTS

Filet radius

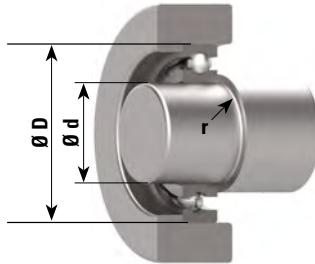

Fillet Radius

The minimum chamfer given in Bearing Drawing and Datasheet will help in designing maximum fillet radius for housing and shaft.

A fillet radius which is too large can cause distortion of the bearing inner and outer ring, and may cause out of squareness of the bearing relative to the seating.

Abutment shoulders

These must be flat, square with the axis of rotation, and free from burrs, to maintain bearing alignment and give proper support to the bearing faces.

Minimum abutment diameter

Minimum abutment diameters for bearings not subject to significant axial load are:

- Inner ring abutment = $d + 4r$ (minimum)
- Outer ring abutment = $D - 4r$ (minimum)

Whereas: d = bearing bore diameter

r = fillet radius (from bearing tables)

D = bearing outside diameter

Maximum abutment diameters

The normal recommendations concerning maximum abutments for radial ball and standard cylindrical roller bearings are given in tables.

It may not always be possible for small bearings to satisfy the minimum abutment recommendations, and in such cases the abutment should be made to the maximum figure in the table.

Abutments for thrust bearings

Thrust bearing abutments must be accurately machined flat and square with the axis of rotation as any misalignment will induce creep. The thrust bearing washers should be supported beyond the pitch diameter of the ball assembly. This may be calculated as

$$Pcd = (d+D)/2$$

Whereas: d = small bore diameter

D = large outside diameter

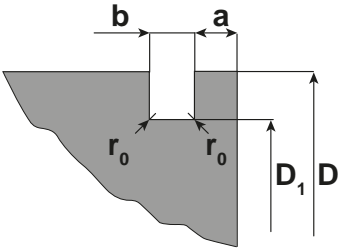

Bearing outer diameter	Size of snap ring groove in mm								
	D1		a Series of sizes 2. 3. 4				b	r ₀	
	max.	min.	max.	min.	max.	min.	max.	min.	max.
30	28.17	27.92	-	-	2.06	1.9	1.65	1.35	0.4
32	30.15	29.9	2.06	1.9	2.06	1.9	1.65	1.35	0.4
35	33.17	32.92	2.06	1.9	1.06	1.9	1.65	1.35	0.4
37	34.77	34.52	-	-	2.06	1.9	1.65	1.35	0.4
40	38.1	37.85	-	-	2.06	1.9	1.65	1.35	0.4
42	39.75	39.5	2.06	1.9	2.06	1.9	1.65	1.35	0.4
44	41.75	41.5	2.06	1.9	-	-	1.65	1.35	0.4
47	44.6	44.35	2.06	1.9	2.46	2.31	1.65	1.35	0.4
50	47.6	47.35	-	-	2.46	2.31	1.65	1.35	0.4
52	49.73	49.48	2.06	1.9	2.46	2.31	1.65	1.35	0.4
55	52.6	52.35	2.08	1.88	-	-	1.65	1.35	0.4
56	53.06	53.35	-	-	2.46	2.31	1.65	1.35	0.4
58	55.6	55.35	1.08	1.88	2.46	2.31	1.65	1.35	0.4
62	59.61	59.11	2.08	1.88	3.28	3.07	2.2	1.9	0.6
65	62.6	62.1	-	-	3.28	3.07	2.2	1.9	0.6
68	64.82	64.31	2.49	2.29	3.28	3.07	2.2	1.9	0.6
72	68.81	68.3	-	-	3.28	3.07	2.2	1.9	0.6
75	71.83	71.32	2.49	2.29	3.28	3.07	2.2	1.9	0.6
80	76.31	76.3	2.49	2.29	3.28	3.07	2.2	1.9	0.6
85	81.81	81.31	-	-	3.28	3.07	2.2	1.9	0.6
90	86.79	86.28	2.87	2.67	3.28	3.07	3	2.7	0.6
95	91.82	91.31	2.87	2.67	-	-	3	2.7	0.6
100	96.8	96.29	2.87	2.67	3.28	3.07	3	2.7	0.6
110	106.81	10.63	2.87	2.67	3.28	3.07	3	2.7	0.6
115	111.81	11.13	2.87	2.67	-	-	3	2.7	0.6
120	115.21	114.71	-	-	4.06	3.86	3.4	3.1	0.6
125	120.22	119.71	2.87	2.67	4.06	3.86	3.4	3.1	0.6
130	125.22	124.71	2.87	2.67	4.06	3.86	3.4	3.1	0.6
140	135.23	134.72	3.71	3.45	4.9	4.64	3.4	3.1	0.6
145	140.23	139.73	3.71	3.45	-	-	3.4	3.1	0.6
150	145.24	144.73	3.71	3.45	4.9	4.65	3.4	3.1	0.6
160	155.22	154.71	3.71	3.45	4.9	4.65	3.4	3.1	0.6
170	163.65	163.14	3.71	3.45	5.69	5.44	3.8	3.5	0.6
180	173.66	173.15	3.71	3.45	5.69	5.44	3.8	3.5	0.6
190	183.64	183.13	-	-	5.69	5.44	3.8	3.5	0.6
200	193.65	193.14	5.69	5.44	5.69	5.44	3.8	3.5	0.6
215	208.6	208.1	-	-	5.69	5.44	3.8	3.5	1

Deep Groove Ball Bearing

SNAP RING DIMENSIONS

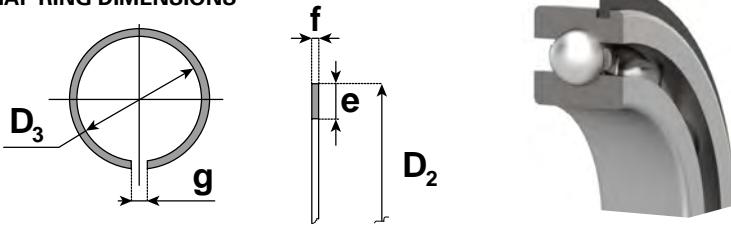

Size of snap ring									Weight g	Snap ring number
D ₂	D ₃	ΔD _{3s}		e		f		g		
max.	nominal	upper	lower	max.	min.	max.	min.			
34.7	27.9	0	-0.4	3.25	3.1	1.12	1.02	3	2.78	SP30
36.7	29.9	0	-0.4	3.25	3.1	1.12	1.02	3	2.98	SP32
39.7	32.9	0	-0.4	3.25	3.1	1.12	1.02	3	3.22	SP35
41.3	34.5	0	-0.4	3.25	3.1	1.12	1.02	3	3.36	SP37
44.6	37.8	0	-0.4	3.25	3.1	1.12	1.02	3	3.6	SP40
46.3	39.5	0	-0.5	3.25	3.1	1.12	1.02	3	3.75	SP42
48.3	41.5	0	-0.5	3.25	3.1	1.12	1.02	3	4	SP44
52.7	44.3	0	-0.5	4.04	3.89	1.12	1.02	4	5.78	SP50
57.9	49.3	0	-0.5	4.04	3.89	1.12	1.02	4	5.92	SP52
60.7	52.3	0	-0.5	4.04	3.89	1.12	1.02	4	6.17	SP55
61.7	53.2	0	-0.6	4.04	3.89	1.12	1.02	4	6.45	SP56
63.7	55.2	0	-0.6	4.04	3.89	1.12	1.02	4	6.67	SP58
67.7	59.0	0	-0.6	4.04	3.89	1.7	1.6	4	10.5	SP62
70.7	62.0	0	-0.6	4.04	3.89	1.7	1.6	4	11	SP65
74.6	64.2	0	-0.6	4.85	4.7	1.7	1.6	5	12.6	SP68
78.6	68.2	0	-0.6	4.85	4.7	1.7	1.6	5	14.7	SP72
81.6	71.2	0	-0.6	4.85	4.7	1.7	1.6	5	15.3	SP75
86.6	76.2	0	-0.6	4.85	4.7	1.7	1.6	5	16.3	SP80
91.6	81.2	0	-0.6	4.85	4.7	1.7	1.6	5	17.5	SP85
96.5	86.2	0	-0.6	4.85	4.7	2.46	2.36	5	26.6	SP90
101.6	91.2	0	-0.6	4.85	4.7	2.46	2.36	5	28.2	SP95
106.6	96.2	0	-0.8	4.85	4.7	2.46	2.36	5	29.2	SP100
116.6	106.2	0	-0.8	4.85	4.7	2.46	2.36	5	32.8	SP110
121.6	112.2	0	-0.8	4.85	4.7	2.46	2.36	5	34.4	SP115
129.7	114.6	0	-0.8	7.21	7.06	2.82	2.72	7	60.6	SP120
134.7	119.6	0	-0.8	7.21	7.06	2.82	2.72	7	63	SP125
139.7	124.6	0	-0.8	7.21	7.06	2.82	2.72	7	65.6	SP130
149.7	134.6	0	-1.2	7.21	7.06	2.82	2.72	7	70.6	SP140
154.7	139.6	0	-1.2	7.21	7.06	2.82	2.72	7	73	SP145
159.7	144.5	0	-1.2	7.21	7.06	2.82	2.72	7	77.2	SP150
169.7	154.5	0	-1.2	7.21	7.06	2.28	2.72	7	81	SP160
182.9	162.9	0	-1.2	9.6	9.45	3.1	3	10	122	SP170
192.9	172.8	0	-1.2	9.6	9.45	3.1	3	10	128	SP180
202.9	182.8	0	-1.4	9.6	9.45	3.1	3	10	139	SP190
212.9	192.8	0	-1.4	9.6	9.45	3.1	3	10	148	SP200
227.8	277.6	0	-1.4	9.6	9.45	3.1	3	10	160	SP215

Dimensions D₂ and g refer to the snap ring fitted in to the bearing groove D₃ represents the nominal inner diameter of the snap ring before mounting.

RADIAL CLEARANCE TABLE

For cylindrical bore



Bore diameter		Clearance class									
d		C2		CN		C3		C4		C5	
mm		µm		µm		µm		µm		µm	
over	up to	min.	max.	min.	max.	min.	max.	min.	max.	min.	max.
2,5	10	0	7	2	13	8	23	14	29	20	37
10	18	0	9	3	18	11	25	18	33	25	45
18	24	0	10	5	20	13	28	20	36	28	48
24	30	1	11	5	20	13	28	23	41	30	53
30	40	1	11	6	20	15	33	28	46	40	64
40	50	1	11	6	23	18	36	30	51	45	73
50	65	1	15	8	28	23	43	38	61	55	90
65	80	1	15	10	30	25	51	46	71	65	105
80	100	1	18	12	36	30	58	53	84	75	120
100	120	2	20	15	41	36	66	61	97	90	140
120	140	2	23	18	48	41	81	71	114	105	160
140	160	2	23	18	53	46	91	81	130	120	180
160	180	2	25	20	61	53	102	91	147	135	200
180	200	2	30	25	71	63	117	107	163	150	230
200	225	2	35	25	85	75	140	125	195	175	265
225	250	2	40	30	95	85	160	145	225	205	300
250	280	2	45	35	105	90	170	155	245	225	340
280	315	2	55	40	115	100	190	175	270	245	370
315	355	3	60	45	125	110	210	195	300	275	410
355	400	3	70	55	145	130	240	225	340	315	460
400	450	3	80	60	170	150	270	250	380	350	510
450	500	3	90	70	190	170	300	280	420	390	570
500	560	10	100	80	210	190	333	310	470	440	630
560	630	10	110	90	230	210	360	340	520	490	690
630	710	20	130	110	260	240	400	380	570	540	780
710	800	20	140	120	290	270	450	430	630	600	840
800	900	20	160	140	320	300	500	480	700	670	940
900	1000	20	170	150	350	330	550	530	770	740	1040
1000	1120	20	180	160	380	360	600	580	850	820	1150
1120	1250	20	190	170	410	390	650	630	920	890	1260
1250	1400	30	220	200	450	430	710	680	1100	980	1380

Deep Groove Ball Bearing

RADIAL CLEARANCE TABLE For tapered bore



Bore diameter		Clearance class							
d		C2		CN		C3		C4	
mm		µm		µm		µm		µm	
over	up to	min.	max.	min.	max.	min.	max.	min.	max.
2,5	10	2	13	8	23	14	29	20	37
10	18	3	18	11	25	18	33	25	45
18	24	5	20	13	28	20	36	28	48
24	30	5	20	13	28	23	41	30	53
30	40	6	20	15	33	28	46	40	64
40	50	6	23	18	36	30	51	45	73
50	65	8	28	23	43	38	61	55	90
65	80	10	30	25	51	46	71	65	105
80	100	12	36	30	58	53	84	75	120
100	120	15	41	36	66	61	97	90	140
120	140	18	48	41	81	71	114	105	160
140	160	18	53	46	91	81	130	120	180
160	180	20	61	53	102	91	147	135	200
180	200	25	71	63	117	107	163	150	230
200	225	25	85	75	140	125	195	175	265
225	250	30	95	85	160	145	225	205	300
250	280	35	105	90	170	155	245	225	340
280	315	40	115	100	190	175	270	245	370
315	355	45	125	110	210	195	300	275	410
355	400	55	145	130	240	225	340	315	460
400	450	60	170	150	270	250	380	350	510
450	500	70	190	170	300	280	420	390	570
500	560	80	210	190	333	310	470	440	630
560	630	90	230	210	360	340	520	490	690
630	710	110	260	240	400	380	570	540	780
710	800	120	290	270	450	430	630	600	840
800	900	140	320	300	500	480	700	670	940
900	1000	150	350	330	550	530	770	740	1040
1000	1120	160	380	360	600	580	850	820	1150
1120	1250	170	410	390	650	630	920	890	1260
1250	1400	200	450	430	710	680	1100	980	1380

Deep Groove Ball Bearing

DATA TABLE



Part number	Principal dimensions			Load ratings			Speed limits		Weight	Radius
	Bore	Outer	Width	Dynamic	Static	Fatigue	Grease	Oil		
	d	D	B	Cr	Cor	Pu	rpm		Kg	rs min mm
	mm			kN			1 min ⁻¹			
623	3	10	4	0,63	0,22	0,01	50000	60000	0,002	0,10
623 ZZ	3	10	4	0,63	0,22	0,01	50000		0,002	0,10
624	4	13	5	1,3	4,85	0,22	40000	48000	0,003	0,20
624 ZZ	4	13	5	1,3	4,85	0,22	40000		0,003	0,20
634	4	16	5	1,34	0,5	0,02	36000	43000	0,005	0,30
634 ZZ	4	16	5	1,34	0,5	0,02	36000		0,005	0,30
625	5	16	5	1,88	6,8	0,31	36000	43000	0,005	0,30
625 ZZ	5	16	5	1,88	6,8	0,31	36000		0,005	0,30
635	5	19	6	2,34	0,88	0,04	32000	40000	0,009	0,30
635 ZZ	5	19	6	2,34	0,88	0,04	32000		0,009	0,30
628/6 ZZ	6	13	5	1,08	0,44	0,02	40000	50000	0,003	0,15
626	6	19	6	2,34	0,88	0,04	32000	40000	0,008	0,30
626 ZZ	6	19	6	2,34	0,88	0,04	32000		0,008	0,30
626 2RS	6	19	6	2,34	0,88	0,04	22000		0,008	0,30
636	6	25	7	3,3	1,37	0,06	30000	36000	0,012	0,30
636 ZZ	6	25	7	3,3	1,37	0,06	30000		0,014	0,30
636 2RS	6	25	7	3,3	1,37	0,06	22500		0,013	0,30
628/7 ZZ	7	14	5	1,17	0,51	0,02	40000	45000	0,003	0,15
607	7	19	6	2,34	0,88	0,04	36000	43000	0,008	0,30
607 ZZ	7	19	6	2,34	0,88	0,04	36000		0,008	0,30
607 2RS	7	19	6	2,34	0,88	0,04	27000		0,008	0,30
627	7	22	7	3,3	1,37	0,06	30000	36000	0,013	0,30
637	7	26	9	4,56	1,98	0,09	28000	34000	0,024	0,30
637 ZZ	7	26	9	4,56	1,98	0,09	28000		0,024	0,30
637 2RS	7	26	9	4,56	1,98	0,09	22500		0,024	0,30
608	8	22	7	3,3	1,37	0,06	34000	40000	0,012	0,30
608 ZZ	8	22	7	3,3	1,37	0,06	34000		0,012	0,30
608 2RS	8	22	7	3,3	1,37	0,06	22500		0,012	0,30
628	8	24	8	3,35	1,43	0,07	28000	34000	0,017	0,30
628 ZZ	8	24	8	3,35	1,43	0,07	28000		0,017	0,30
628 2RS	8	24	8	3,35	1,43	0,07	21000		0,017	0,30
638	8	28	9	4,55	1,97	0,09	28000	34000	0,028	0,30
638 ZZ	8	28	9	4,55	1,97	0,09	28000		0,028	0,30
609	9	24	7	3,35	1,43	0,07	32000	38000	0,014	0,30
609 ZZ	9	24	7	3,35	1,43	0,07	32000		0,014	0,30

Deep Groove Ball Bearing

DATA TABLE



Part number	Principal dimensions			Load ratings			Speed limits		Weight	Radius
	Bore	Outer	Width	Dynamic	Static	Fatigue	Grease	Oil		
	d	D	B	Cr	Cor	Pu	rpm		Kg	rs min mm
	mm			kN			1 min ⁻¹			
609 2RS	9	24	7	3,35	1,43	0,07	24000		0,014	0,30
629	9	26	8	4,55	1,97	0,09	28000	34000	0,019	0,30
629 ZZ	9	26	8	4,55	1,97	0,09	28000		0,019	0,30
629 2RS	9	26	8	4,55	1,97	0,09	21000		0,019	0,30
639	9	30	10	4,65	2,07	0,09	24000	30000	0,035	0,60
639 ZZ	9	30	10	4,65	2,07	0,09	24000		0,035	0,60
61800	10	19	5	1,7	0,83	0,04	34000	40000	0,005	0,30
61800 ZZ	10	19	5	1,7	0,83	0,04	34000		0,005	0,30
61900	10	22	6	1,95	0,75	0,03	32000	38000	0,01	0,30
61900 ZZ	10	22	6	1,95	0,75	0,03	32000		0,01	0,30
6000	10	26	8	4,55	1,97	0,09	30000	36000	0,02	0,30
6000 ZZ	10	26	8	4,55	1,97	0,09	30000		0,02	0,30
6000 2RS	10	26	8	4,55	1,97	0,09	22500		0,02	0,30
6200	10	30	9	5,1	2,39	0,11	24000	30000	0,032	0,60
6200 ZZ	10	30	9	5,1	2,39	0,11	24000		0,032	0,60
6200 2RS	10	30	9	5,1	2,39	0,11	18000		0,032	0,60
6300	10	35	11	8,1	3,45	0,16	22000	26000	0,055	0,60
6300 ZZ	10	35	11	8,1	3,45	0,16	22000		0,055	0,60
6300 2RS	10	35	11	8,1	3,45	0,16	16500		0,055	0,60
61801	12	21	5	1,8	0,95	0,04	32000	38000	0,006	0,30
61801 ZZ	12	21	5	1,8	0,95	0,04	32000		0,006	0,30
61901	12	24	6	2,9	1,45	0,07	30000	36000	0,011	0,30
61901 ZZ	12	24	6	2,9	1,45	0,07	30000		0,011	0,30
16001	12	28	7	5,1	2,37	0,11	28000	32000	0,018	0,30
6001	12	28	8	5,1	2,37	0,11	28000	32000	0,021	0,30
6001 ZZ	12	28	8	5,1	2,37	0,11	28000		0,021	0,30
6001 2RS	12	28	8	5,1	2,37	0,11	21000		0,021	0,30
6201	12	32	10	6,8	3,05	0,14	22000	28000	0,038	0,60
6201 ZZ	12	32	10	6,8	3,05	0,14	22000		0,038	0,60
6201 2RS	12	32	10	6,8	3,05	0,14	16500		0,038	0,60
6301	12	37	12	9,7	4,2	0,19	20000	24000	0,06	1,00
6301 ZZ	12	37	12	9,7	4,2	0,19	20000		0,06	1,00
6301 2RS	12	37	12	9,7	4,2	0,19	15000		0,06	1,00
61802	15	24	5	2	1,25	0,06	28000	34000	0,007	0,30
61802 ZZ	15	24	5	2	1,25	0,06	28000		0,007	0,30

Deep Groove Ball Bearing

DATA TABLE



Part number	Principal dimensions			Load ratings			Speed limits		Weight	Radius
	Bore	Outer	Width	Dynamic	Static	Fatigue	Grease	Oil		
	d	D	B	Cr	Cor	Pu	rpm		Kg	rs min mm
	mm			kN			1 min ⁻¹			
61902	15	28	7	4,35	2,26	0,10	26000	30000	0,017	0,30
61902 ZZ	15	28	7	4,35	2,26	0,10	26000		0,017	0,30
16002	15	32	8	5,6	2,83	0,13	24000	28000	0,027	0,30
6002	15	32	9	5,6	2,83	0,13	24000	28000	0,028	0,30
6002 ZZ	15	32	9	5,6	2,83	0,13	24000		0,028	0,30
6002 2RS	15	32	9	5,6	2,83	0,13	24000		0,028	0,30
6202	15	35	11	7,75	3,57	0,16	20000	24000	0,045	0,50
6202 ZZ	15	35	11	7,75	3,57	0,16	20000		0,045	0,50
6202 2RS	15	35	11	7,75	3,57	0,16	20000		0,045	0,50
6302	15	42	13	11,4	5,45	0,25	17000	20000	0,08	1,00
6302 ZZ	15	42	13	11,4	5,45	0,25	17000		0,08	1,00
6302 2RS	15	42	13	11,4	5,45	0,25	12750		0,08	1,00
61803	17	26	5	2,2	1,4	0,06	26000	30000	0,009	0,30
61803 ZZ	17	26	5	2,2	1,4	0,06	26000		0,009	0,30
61903	17	30	7	4,35	2,3	0,10	24000	28000	0,018	0,30
61903 ZZ	17	30	7	4,35	2,3	0,10	24000		0,018	0,30
16003	17	35	8	6	3,25	0,15	22000	26000	0,04	0,30
6003	17	35	10	6	3,25	0,15	22000	26000	0,035	0,30
6003 ZZ	17	35	10	6	3,25	0,15	22000		0,035	0,30
6003 2RS	17	35	10	6	3,25	0,15	16500		0,035	0,30
6203	17	40	12	9,55	4,8	0,22	17000	20000	0,066	0,60
6203 ZZ	17	40	12	9,55	4,8	0,22	17000		0,066	0,60
6203 2RS	17	40	12	9,55	4,8	0,22	17000		0,066	0,60
6303	17	47	14	13,6	6,65	0,30	15000	18000	0,11	1,00
6303 ZZ	17	47	14	13,6	6,65	0,30	15000		0,11	1,00
6303 2RS	17	47	14	13,6	6,65	0,30	11250		0,11	1,00
61804	20	32	7	3,45	2,25	0,10	22000	26000	0,02	0,30
61804 ZZ	20	32	7	3,45	2,25	0,10	22000		0,02	0,30
61904	20	37	9	6,55	3,65	0,17	19000	22000	0,036	0,30
61904 ZZ	20	37	9	6,55	3,65	0,17	19000		0,036	0,30
16004	20	42	8	7,95	4,5	0,20	18000	20000	0,05	0,30
6004	20	42	12	9,4	5	0,23	18000	20000	0,063	0,60
6004 ZZ	20	42	12	9,4	5	0,23	18000		0,063	0,60
6004 2RS	20	42	12	9,4	5	0,23	13500		0,063	0,60
6204	20	47	14	12,8	6,6	0,30	15000	18000	0,11	1,00

Deep Groove Ball Bearing

DATA TABLE



Part number	Principal dimensions			Load ratings			Speed limits		Weight	Radius
	Bore	Outer	Width	Dynamic	Static	Fatigue	Grease	Oil		
	d	D	B	Cr	Cor	Pu	rpm		Kg	rs min
mm			kN			1 min ⁻¹		mm		
6204 ZZ	20	47	14	12,8	6,6	0,30	15000		0,11	1,00
6204 2RS	20	47	14	12,8	6,6	0,30	11250		0,11	1,00
6304	20	52	15	15,9	7,9	0,36	14000	17000	0,14	1,10
6304 ZZ	20	52	15	15,9	7,9	0,36	14000		0,14	1,10
6304 2RS	20	52	15	15,9	7,9	0,36	10500		0,14	1,10
61805	25	37	7	4,35	2,95	0,13	18000	22000	0,022	0,30
61805 ZZ	25	37	7	4,35	2,95	0,13	18000		0,022	0,30
61905	25	42	9	7	4,45	0,20	16000	19000	0,041	0,30
61905 ZZ	25	42	9	7	4,45	0,20	16000		0,041	0,30
16005	25	47	8	8,85	5,6	0,25	15000	18000	0,058	0,30
6005	25	47	12	10,1	5,85	0,27	15000	18000	0,08	0,60
6005 ZZ	25	47	12	10,1	5,85	0,27	15000		0,08	0,60
6005 2RS	25	47	12	10,1	5,85	0,27	11250		0,08	0,60
6205	25	52	15	14	7,85	0,36	13000	15000	0,13	1,00
6205 ZZ	25	52	15	14	7,85	0,36	13000		0,13	1,00
6205 2RS	25	52	15	14	7,85	0,36	9750		0,13	1,00
6305	25	62	17	23,6	11,6	0,53	11000	13000	0,25	1,10
6305 ZZ	25	62	17	23,6	11,6	0,53	11000		0,25	1,10
6305 2RS	25	62	17	23,6	11,6	0,53	8250		0,25	1,10
6405	25	80	21	37,2	18,7	0,85	9000	11000	0,525	1,50
61806	30	42	7	4,4	2,9	0,13	15000	18000	0,027	0,30
61906	30	47	9	7,8	4,7	0,21	14000	17000	0,045	0,30
16006	30	55	9	11,2	7,35	0,33	12000	15000	0,09	3,00
6006 ZZ	30	55	13	13,11	7,9	0,36	17000		0,12	1,00
6006 2RS	30	55	13	13,11	7,9	0,36	11900		0,12	1,00
6206	30	62	16	19,5	11,3	0,51	10000	13000	0,21	1,00
6206 ZZ	30	62	16	19,5	11,3	0,51	10000		0,21	1,00
6206 2RS	30	62	16	19,5	11,3	0,51	7500		0,21	1,00
62206 2RS	30	62	20	19,46	11,31	0,51	11000		0,25	1,00
6306	30	72	19	28,2	15,8	0,72	9000	11000	0,371	1,10
6306 ZZ	30	72	19	28,2	15,8	0,72	9000		0,371	1,10
6306 2RS	30	72	19	28,2	15,8	0,72	6000		0,371	1,10
6406	30	90	23	47,3	24,5	1,11	8500	10000	0,785	1,50
61807	35	47	7	4	3,25	0,15	13000	16000	0,031	0,30
61907	35	55	10	9,5	6,2	0,28	12000	14000	0,073	0,60

Deep Groove Ball Bearing

DATA TABLE



Part number	Principal dimensions			Load ratings			Speed limits		Weight	Radius
	Bore	Outer	Width	Dynamic	Static	Fatigue	Grease	Oil		
	d	D	B	Cr	Cor	Pu	rpm		Kg	rs min mm
	mm			kN			1 min ⁻¹			
16007	35	62	9	12,2	8,85	0,40	10000	13000	0,11	0,30
6007	35	62	14	16,6	10,3	0,47	10000	13000	0,16	1,00
6007 2RS	35	62	14	16,6	10,3	0,47	7500		0,18	1,00
6207	35	72	17	25,7	15,4	0,70	9000	11000	0,315	1,10
6207 ZZ	35	72	17	25,7	15,4	0,70	9000		0,315	1,10
6207 2RS	35	72	17	25,7	15,4	0,70	6000		0,315	1,10
6307	35	80	21	33,5	18,3	0,83	8500	10000	0,45	1,50
6307 ZZ	35	80	21	33,5	18,3	0,83	8500		0,45	1,50
6307 2RS	35	80	21	33,5	18,3	0,83	5600		0,45	1,50
6407	35	100	25	55,5	29,4	1,34	7000	8500	0,954	1,50
61808	40	52	7	4,69	3,28	0,15	12000	14000	0,034	0,30
61908	40	62	12	14,5	10,2	0,46	11000	13000	0,11	0,60
16008	40	68	9	13,3	9,8	0,45	9500	12000	0,13	0,30
6008	40	68	15	16,8	11,6	0,53	9500	12000	0,21	1,00
6008 ZZ	40	68	15	16,8	11,6	0,53	9500		0,21	1,00
6008 2RS	40	68	15	16,8	11,6	0,53	6000		0,21	1,00
6208	40	80	18	32	17,8	0,81	8500	10000	0,402	1,10
6208 ZZ	40	80	18	32	17,8	0,81	8500		0,402	1,10
6208 2RS	40	80	18	32	17,8	0,81	5600		0,402	1,10
6308	40	90	23	40,7	24	1,09	7500	9000	0,635	1,50
6308 ZZ	40	90	23	40,7	24	1,09	7500		0,635	1,50
6308 2RS	40	90	23	40,7	24	1,09	5000		0,635	1,50
6408	40	110	27	64	36	1,64	6700	7500	1,23	2,00
61809	45	58	7	6,4	5,6	0,25	9500	12000	0,043	0,30
61909	45	68	12	14	9,8	0,45	9700	11000	0,12	0,60
16009	45	75	10	15,5	12,3	0,56	9000	11000	0,17	0,60
6009	45	75	16	21	15	0,68	9000	11000	0,261	1,00
6009 ZZ	45	75	16	21	15	0,68	9000		0,261	1,00
6009 2RS	45	75	16	21	15	0,68	5600		0,261	1,00
6209	45	85	19	31,6	20,2	0,92	7500	9000	0,414	1,10
6209 ZZ	45	85	19	31,6	20,2	0,92	7500		0,414	1,10
6209 2RS	45	85	19	31,6	20,2	0,92	5300		0,414	1,10
6309	45	100	25	52,8	31,7	1,44	6700	8000	0,838	1,50
6309 ZZ	45	100	25	52,8	31,7	1,44	6700		0,838	1,50
6309 2RS	45	100	25	52,8	31,7	1,44	4500		0,838	1,50
6409	45	120	29	76,8	44,9	2,04	5600	6700	1,54	2,00

Deep Groove Ball Bearing

DATA TABLE



Part number	Principal dimensions			Load ratings			Speed limits		Weight	Radius
	Bore	Outer	Width	Dynamic	Static	Fatigue	Grease	Oil		
	d	D	B	Cr	Cor	Pu	rpm		Kg	rs min
	mm			kN			1 min ⁻¹			mm
61810	50	65	7	6,8	6,3	0,29	9500	12000	0,06	0,30
61910	50	72	12	14,5	10,4	0,47	9000	11000	0,13	0,60
16010	50	80	10	16,3	13,1	0,60	8500	10000	0,19	0,60
6010	50	80	16	21,8	16,5	0,75	8500	10000	0,26	1,00
6010 ZZ	50	80	16	21,8	16,5	0,75	8500		0,26	1,00
6010 2RS	50	80	16	21,8	16,5	0,75	5300		0,26	1,00
6210	50	90	20	35,1	23,1	1,05	7000	8500	0,46	1,10
6210 ZZ	50	90	20	35,1	23,1	1,05	7000		0,46	1,10
6210 2RS	50	90	20	35,1	23,1	1,05	4500		0,46	1,10
6310	50	110	27	61,8	37,7	1,71	6000	7000	1,08	2,00
6310 ZZ	50	110	27	61,8	37,9	1,72	6000		1,06	2,00
6310 2RS	50	110	27	61,8	37,9	1,72	4000		1,06	2,00
6410	50	130	31	87,1	52	2,36	5000	6000	1,89	2,10
61811	55	72	9	9	8,5	0,39	8500	10000	0,08	0,30
16011	55	90	11	19,3	16,3	0,74	7500	9000	0,26	0,60
6011	55	90	18	28,3	21,2	0,96	7500	9000	0,39	1,10
6011 ZZ	55	90	18	28,3	21,2	0,96	7500		0,39	1,10
6011 2RS	55	90	18	28,3	21,2	0,96	4500		0,39	1,10
6211	55	100	21	43,4	29,3	1,33	6300	7500	0,61	1,50
6211 ZZ	55	100	21	43,4	29,3	1,33	6300		0,61	1,50
6211 2RS	55	100	21	43,4	29,3	1,33	4000		0,61	1,50
6311	55	120	29	71,5	44,6	2,03	5300	6300	1,38	2,00
6311 ZZ	55	120	29	71,5	44,6	2,03	5300		1,38	2,00
6311 2RS	55	120	29	71,5	44,6	2,03	3600		1,38	2,00
6411	55	140	33	100	62	2,82	4800	5600	2,3	2,10
61812	60	78	10	8,7	6,7	0,30	8000	9500	0,12	0,30
16012	60	95	11	20	17,6	0,80	7000	8500	0,28	0,60
6012	60	95	18	32	23,2	1,05	6700	8000	0,42	1,10
6012 ZZ	60	95	18	32	23,2	1,05	6700		0,42	1,10
6012 2RS	60	95	18	32	23,2	1,05	4300		0,42	1,10
6212	60	110	22	52,4	36	1,64	6000	7000	0,78	1,50
6212 ZZ	60	110	22	52,4	36	1,64	6000		0,78	1,50
6212 2RS	60	110	22	52,4	36	1,64	4000		0,78	1,50
6312	60	130	31	85,8	52	2,36	5000	6000	1,72	2,10
6312 ZZ	60	130	31	85,8	52	2,36	5000		1,72	2,10

Deep Groove Ball Bearing

DATA TABLE



Part number	Principal dimensions			Load ratings			Speed limits		Weight	Radius
	Bore	Outer	Width	Dynamic	Static	Fatigue	Grease	Oil		
	d	D	B	Cr	Cor	Pu	rpm		Kg	rs min mm
	mm			kN			1 min ⁻¹			
6312 2RS	60	130	31	85,8	52	2,36	3400		1,72	2,10
6412	60	150	35	110	70,8	3,14	4300	5000	2,76	2,10
61813	65	85	10	12,2	12	0,55	7000	8500	0,13	0,60
16013	65	100	11	22,9	19,6	0,89	6300	7500	0,3	0,60
6013	65	100	18	31,9	25,2	1,15	6300	7500	0,44	1,10
6013 ZZ	65	100	18	31,9	25,2	1,15	6300		0,44	1,10
6013 2RS	65	100	18	31,9	25,2	1,15	4000		0,44	1,10
6213	65	120	23	57,2	40	1,82	5300	6300	1	1,50
6213 ZZ	65	120	23	57,2	40	1,82	5300		1	1,50
6213 2RS	65	120	23	57,2	40	1,82	3600		1	1,50
6313	65	140	33	92,7	59,7	2,68	4800	5600	2,1	2,10
6313 ZZ	65	140	33	92,7	59,7	2,68	4800		2,1	2,10
6313 2RS	65	140	33	92,7	59,7	2,68	3000		2,1	2,10
6413	65	160	37	118	79	3,39	4000	4800	3,3	2,10
61814	70	90	10	12,5	10	0,45	6700	8000	0,16	0,60
61914 2RS	70	100	16	23,7	21,2	0,96	7700	6500	0,33	1,00
16014	70	110	13	27,9	25	1,14	6000	7000	0,43	0,60
6014	70	110	20	38,1	30,9	1,40	6000	7000	0,6	1,10
6014 ZZ	70	110	20	38,1	30,9	1,40	6000		0,6	1,10
6014 2RS	70	110	20	38,1	30,9	1,40	3600		0,6	1,10
6214	70	125	24	62,2	44,1	2,00	5000	6000	1,07	1,50
6214 ZZ	70	125	24	62,2	44,1	2,00	5000		1,07	1,50
6214 2RS	70	125	24	62,2	44,1	2,00	3400		1,07	1,50
6314	70	150	35	109,4	68,1	2,95	4500	5300	2,5	2,10
6314 ZZ	70	150	35	109,4	68,1	2,95	4500		2,5	2,10
6314 2RS	70	150	35	109,4	68,1	2,95	2800		2,5	2,10
6414	70	180	42	144	104	4,23	3800	4500	4,85	3,00
16015	75	115	13	29	26,8	1,22	5600	6700	0,46	0,60
6015	75	115	20	39,7	33,5	1,52	5600	6700	0,64	1,10
6015 ZZ	75	115	20	39,7	33,5	1,52	5600		0,64	1,10
6015 2RS	75	115	20	39,7	33,5	1,52	3400		0,64	1,10
6215	75	130	25	67,4	49,3	2,21	4800	5600	1,18	1,50
6215 ZZ	75	130	25	67,4	49,3	2,21	4800		1,18	1,50
6215 2RS	75	130	25	67,4	49,3	2,21	3200		1,18	1,50
6315	75	160	37	113	77	3,23	4000	4800	3,03	2,10

Deep Groove Ball Bearing

DATA TABLE



Part number	Principal dimensions			Load ratings			Speed limits		Weight	Radius
	Bore	Outer	Width	Dynamic	Static	Fatigue	Grease	Oil		
	d	D	B	Cr	Cor	Pu	rpm		Kg	rs min
mm			kN			1 min ⁻¹				mm
6315 ZZ	75	160	37	113	77	3,23	4000		3,03	2,10
6315 2RS	75	160	37	113	77	3,23	2800		3,03	2,10
6415	75	190	45	154	115	4,54	3600	4300	6,5	3,00
61816	80	100	10	12,9	13,7	0,62	6000	7000	0,16	0,60
61916	80	110	16	25,1	20,5	0,93	5600	6700	0,38	1,00
16016	80	125	14	31,9	29,7	1,33	5300	6300	0,6	0,60
6016	80	125	22	47,6	39,8	1,79	5300	6300	0,85	1,10
6016 ZZ	80	125	22	47,6	39,8	1,79	5300		0,85	1,10
6016 2RS	80	125	22	47,6	39,8	1,79	3600		0,85	1,10
6216	80	140	26	71,45	53	2,30	4500	5300	1,4	2,00
6216 ZZ	80	140	26	71,45	53	2,30	4500		1,4	2,00
6216 2RS	80	140	26	71,45	53	2,30	3000		1,4	2,00
6316	80	170	39	123	86,5	3,52	3800	4500	3,6	2,10
6316 ZZ	80	170	39	123	86,5	3,52	3800		3,6	2,10
6416	80	200	48	164	125	4,80	3400	4000	7,5	3,00
61817	85	110	13	19,3	20	0,91	5300	6300	0,29	1,00
16017	85	130	14	33,8	33,5	1,47	5000	6000	0,63	1,00
6017	85	130	22	49,5	43,1	1,89	5000	6000	0,89	1,10
6017 ZZ	85	130	22	49,5	43,1	1,89	5000		0,89	1,10
6017 2RS	85	130	22	49,5	43,1	1,89	3400		0,89	1,10
6217	85	150	28	84	61,9	2,60	4300	5000	1,8	2,00
6217 ZZ	85	150	28	84	61,9	2,60	4300		1,8	2,00
6217 2RS	85	150	28	84	61,9	2,60	2800		1,8	2,00
6317	85	180	41	133	96,6	3,81	3600	4300	4,2	3,00
6317 ZZ	85	180	41	133	96,6	3,81	3600		4,2	3,00
6417	85	210	52	173	136	5,09	3200	3800	9	4,00
61818	90	115	13	19,6	20,4	0,92	5300	6300	0,3	1,00
16018	90	140	16	41,9	40,4	1,71	4500	5300	0,85	1,00
6018	90	140	24	58,2	49,7	2,11	4500	5300	1,16	1,50
6018 ZZ	90	140	24	58,2	49,7	2,11	4500		1,16	1,50
6018 2RS	90	140	24	58,2	49,7	2,11	3000		1,16	1,50
6218	90	160	30	96	71,5	2,91	3800	4500	2,16	2,00
6218 ZZ	90	160	30	96	71,5	2,91	3800		2,16	2,00
6218 2RS	90	160	30	96	71,5	2,91	3000		2,16	2,00
6318	90	190	43	143	107	4,11	3400	4000	4,9	3,00

Deep Groove Ball Bearing

DATA TABLE



Part number	Principal dimensions			Load ratings			Speed limits		Weight	Radius
	Bore	Outer	Width	Dynamic	Static	Fatigue	Grease	Oil		
	d	D	B	Cr	Cor	Pu	rpm		Kg	rs min mm
	mm			kN			1 min ⁻¹			
6318 ZZ	90	190	43	143	107	4,11	3400		4,9	3,00
6418	90	225	54	190	160	5,80	3000	3600	11,5	4,00
16019	95	145	16	42,3	41,5	1,72	4300	5000	0,89	1,00
6019	95	145	24	60,5	53,6	2,22	4300	5000	1,2	1,50
6019 ZZ	95	145	24	60,5	53,6	2,22	4300		1,2	1,50
6019 2RS	95	145	24	60,5	53,6	2,22	2800		1,2	1,50
6219	95	170	32	109	81,9	3,23	3600	4300	2,6	2,10
6219 ZZ	95	170	32	109	81,9	3,23	3600		2,6	2,10
6319	95	200	45	153	118	4,42	3200	3800	5,6	3,00
61820	100	125	13	19,6	21,2	0,91	4800	5600	0,32	1,00
16020	100	150	16	45	44	1,79	4300	5000	0,91	1,00
6020	100	150	24	64,6	55,9	2,27	4300	5000	1,25	1,50
6020 ZZ	100	150	24	64,6	55,9	2,27	4300		1,25	1,50
6020 2RS	100	150	24	64,6	55,9	2,27	2800		1,25	1,50
6220	100	180	34	124	93	3,57	3400	4000	3,1	2,10
6220 ZZ	100	180	34	124	93	3,57	3400		3,1	2,10
6220 2RS	100	180	34	124	93	3,57	2500		3,1	2,10
6320	100	215	47	173	140	5,07	3000	3600	7	3,00
6320 ZZ	100	215	47	173	140	5,07	3000		7	3,00
16021	105	160	18	52	51	2,01	4000	4800	1,2	1,00
6021	105	160	26	72,4	65,8	2,60	3800	4500	1,6	2,00
6021 ZZ	105	160	26	72,4	65,8	2,60	3800		1,6	2,00
6221	105	190	36	133	104	3,89	3200	3800	3,7	2,10
6321	105	225	49	184	153	5,41	2800	3400	8	3,00
61822	110	140	16	28,1	29	1,18	4300	5000	0,6	1,00
61922	110	150	20	40,6	42	1,67	3600	4500	0,84	1,10
16022	110	170	19	57,5	56,7	2,18	3800	4500	1,46	1,00
6022	110	170	28	82	73	2,80	3600	4300	1,95	2,00
6022 ZZ	110	170	28	82	73	2,80	3600		1,95	2,00
6222	110	200	38	143	118	4,31	3000	3600	4,35	2,10
6222 ZZ	110	200	38	143	118	4,31	3000		4,35	2,10
6322	110	240	50	203	178	6,12	2600	3200	9,58	3,00
6322 M	110	240	50	204,5	177,2	6,09	2400	3200	11,2	3,00
61824	120	150	16	29,1	32,5	1,27	3800	4500	0,65	1,00
61924	120	165	22	53	54	2,06	3600	4300	1,21	1,10

Deep Groove Ball Bearing

DATA TABLE



OPEN

SEALS | 2RS

SHIELD | ZZ

Part number	Principal dimensions			Load ratings			Speed limits		Weight	Radius
	Bore	Outer	Width	Dynamic	Static	Fatigue	Grease	Oil		
	d	D	B	Cr	Cor	Pu	rpm		Kg	rs min mm
	mm			kN			1 min ⁻¹			
16024	120	180	19	63,2	63,3	2,35	3400	4000	1,7	1,00
6024	120	180	28	88,48	79,3	2,94	3400	4000	2,09	2,00
6024 ZZ	120	180	28	88,48	79,3	2,94	3400		2,09	2,00
6024 2RS	120	180	28	85	79,3	2,94	2500		2,09	2,00
6224	120	215	40	155	131	4,60	2800	3400	5,15	2,10
6224 ZZ	120	215	40	155	131	4,60	2800		5,15	2,10
6324	120	260	55	212	190	6,27	2400	3000	12,1	3,00
16026	130	165	18	38	43	1,61	3600	4300	0,93	1,10
61826	130	165	18	38	43	1,61	3600	4300	0,93	1,10
61926 M	130	180	24	65	67	2,45	3400	4000	1,92	1,50
6026	130	200	33	102,2	101	3,57	3000	3600	3,25	2,00
6026 ZZ	130	200	33	102,2	101	3,57	3000		3,25	2,00
6226	130	230	40	167	146	4,95	2600	3200	6	3,00
6326	130	280	58	229	214	6,79	2200	2800	14,7	4,00
16028	140	210	22	80,5	86	2,95	2800	3400	2,7	1,10
6028	140	210	33	105,7	109	3,75	2800	3400	3,35	2,00
6028 ZZ	140	210	33	105,7	109	3,75	2800		3,35	2,00
6228	140	250	42	178,9	167,8	5,46	2400	3000	7,5	3,00
6228 M	140	250	42	166	150	4,88	2400	300	9,44	3,00
6328	140	300	62	253	246	7,54	2000	2600	21	4,00
6328 M	140	300	62	273,5	272,5	8,35	2100	2500	21	4,00
61830	150	190	20	48,8	61	2,13	3000	3600	1,4	1,10
61930 M	150	210	28	84,5	90	3,05	2800	3400	3,04	2,00
16030	150	225	24	92,3	98	3,25	2600	3200	3,4	1,10
6030	150	225	35	125	126	4,18	2600	3200	4,75	2,10
6030 ZZ	150	225	35	125	126	4,18	2600		4,75	2,10
6030 2RS	150	225	35	125	126	4,18	1950		4,7	2,10
6230	150	270	45	176	170	5,33	2000	2600	9,6	3,00
6330	150	320	65	275	284	8,42	1900	2400	25	4,00
61832	160	200	20	52	62	2,10	2800	3400	1,49	1,10
61932 M	160	220	28	90	95	3,13	2500	3100	3,15	2,00
16032	160	240	25	99,4	107	3,44	2400	3000	3,6	1,50
6032	160	240	38	143,6	143	4,60	2400	3000	5,85	2,10
6032 ZZ	160	240	38	143,6	143	4,60	2400		5,85	2,10
6232	160	290	48	197,4	199	6,03	1900	2400	15	3,00

Deep Groove Ball Bearing

DATA TABLE



Part number	Principal dimensions			Load ratings			Speed limits		Weight	Radius
	Bore	Outer	Width	Dynamic	Static	Fatigue	Grease	Oil		
	d	D	B	Cr	Cor	Pu	rpm		Kg	rs min mm
	mm			kN			1 min ⁻¹			
6332 M	160	340	68	313	338,4	9,73	1900	2300	29,9	3,00
61834M	170	215	22	55	67	2,20	2600	3200	2,14	2,00
61934 M	170	230	28	115	100	3,21	2400	3000	3,4	2,00
16034	170	260	28	118	127	3,94	2200	2800	5,7	1,50
6034	170	260	42	168	172	5,33	2200	2800	7,8	2,10
6234	170	310	52	227	240	7,04	1900	2400	15,2	4,00
6234 M	170	310	52	227	240	7,04	1900	2400	18,4	4,00
61836	180	225	22	62,3	78,5	2,51	2400	3000	2	1,10
61936	180	250	33	128	137	4,25	2200	2800	4,9	2,00
16036 M	180	280	31	125	150	4,50	2000	2600	7,9	2,00
6036 M	180	280	46	195	202	6,05	2000	2600	10,7	2,10
6036	180	280	46	186	194	5,81	2000	2600	10,5	2,10
6236	180	320	52	227	242	6,96	1800	2200	18,5	4,00
61838	190	240	24	74,2	91,5	2,84	2200	2800	2,6	1,50
16038	190	290	31	148	162	4,75	2000	2600	7,9	2,00
6038	190	290	46	194	210	6,16	2000	2600	11	2,10
6238	190	340	55	255	278	7,76	1700	2000	23	4,00
61840 M	200	250	24	74,2	84	2,55	2200	2800	2,68	1,50
61940 M	200	280	38	125	144	4,23	2000	2600	7,63	2,10
16040 M	200	310	34	160	179	5,10	1900	2400	10,3	2,00
6040 M	200	310	51	222	245	6,97	1900	2400	14,3	2,10
6240 M	200	360	58	288	335	9,10	1700	2000	24,4	4,00
61844 M	220	270	24	78,3	101,5	2,95	1900	2400	3,21	1,50
61944 M	220	300	38	175	162	4,57	1900	2400	8	2,10
16044	220	340	37	181	215	5,84	1800	2200	11,7	2,10
6044 M	220	340	56	245	293	7,96	1800	2200	18,8	3,00
6244	220	400	65	297	365	9,42	1500	1800	31,2	4,00
6344	220	460	88	403	520	12,82	1300	1600	71,4	5,00
6646 M	230	329,5	40	191	227	6,17	1600	2000	10,4	2,10
61848 M	240	300	28	103	116	3,21	1800	2200	4,78	2,00
61948 M	240	320	38	155	186	5,05	1800	2200	8,1	2,10
16048 M	240	360	37	188	228	5,98	1700	2000	14,5	2,10
6048 M	240	360	56	255	315	8,27	1700	2000	20,7	3,00
6248	240	440	72	360	470	11,59	1300	1600	51,8	4,00
61852 M	260	320	28	122	128	3,42	1700	2000	4,85	2,00

Deep Groove Ball Bearing

DATA TABLE



Part number	Principal dimensions			Load ratings			Speed limits		Weight	Radius
	Bore	Outer	Width	Dynamic	Static	Fatigue	Grease	Oil		
	d	D	B	C_r	C_{or}	P_u	rpm		Kg	r_s min
	mm			kN			1 min^{-1}			mm
61952 M	260	360	46	212	269	6,94	1600	1900	14,4	2,10
16052 M	260	400	44	230	300	7,51	1500	1800	22	3,00
6052 M	260	400	65	294	375	9,38	1500	1800	28,8	4,00
61856 M	280	350	33	131	188	4,81	1600	1900	7,17	2,00
61956 M	280	380	46	215	282	7,06	1500	1800	15,6	2,10
16056	280	420	44	235	330	8,02	1300	1600	22,5	3,00
6056	280	420	65	305	405	9,84	1400	1700	32,2	4,00
6256	280	500	80	410	600	13,81	1000	1300	72	5,00
6356	280	580	108	560	840	18,41	1000	1200	141	6,00
61860 M	300	380	38	163	206	5,08	1400	1700	10,4	2,10
61960	300	420	56	267	370	8,86	1300	1600	20,7	3,00
6060	300	460	74	340	480	11,19	1200	1500	48,4	4,00
6260	300	540	85	450	665	14,75	950	1200	88	5,00
61864 M	320	400	38	164	220	5,27	1300	1600	11,4	2,10
60964	320	440	37	210	305	7,11	1200	1400	15,5	2,10
61964	320	440	56	278	395	9,21	1300	1600	24,9	3,00
16064	320	480	50	275	400	9,09	1100	1300	34	4,00
6064	320	480	74	355	510	11,59	1100	1400	50,3	4,00
6264	320	580	92	515	780	16,71	1000	1200	111	5,00
61868 M	340	420	38	169	227	5,29	1200	1500	11,6	2,10
61968 M	340	460	56	282	420	9,55	1100	1400	27	3,00
16068	340	520	57	335	520	11,40	950	1200	46	4,00
6068	340	520	82	403	620	13,59	1000	1300	63,4	5,00
6268	340	620	92	545	890	18,46	900	1000	112	6,00
60872	360	440	25	118	210	4,77	1130	1450	6,5	1,50
61872 M	360	440	38	182	290	6,59	1100	1400	12,2	2,10
61972 M	360	480	56	282	425	9,43	1100	1400	30,2	3,00
6072 M	360	530	82	355	620	13,36	1000	1300	59,8	5,00
16072	360	540	57	340	540	11,57	1000	1200	50	4,00
61876 MA	380	480	46	240	390	8,55	1000	1300	19	2,10
61976	380	520	65	345	550	11,79	1000	1300	39,8	4,00
16076	380	560	57	368	615	12,89	940	1100	50	4,00
60880	400	500	31	159	277	5,94	1000	1200	15	2,00
61880	400	500	46	242	403	8,64	1000	1200	21	2,10
60980	400	540	44	258	435	9,12	980	1250	27,5	3,00
61980	400	540	65	355	585	12,27	950	1200	43,6	4,00

Deep Groove Ball Bearing

DATA TABLE



Part number	Principal dimensions			Load ratings			Speed limits		Weight	Radius
	Bore	Outer	Width	Dynamic	Static	Fatigue	Grease	Oil		
	d	D	B	Cr	Cor	Pu	rpm		Kg	rs min mm
	mm			kN			1 min ⁻¹			
6080 M	400	600	90	495	780	15,86	900	1100	87,9	5,00
61884	420	520	46	245	420	8,81	980	1250	21,5	2,10
61984 M	420	560	65	320	520	10,68	900	1100	46,2	4,00
6084	420	620	90	495	875	17,44	910	1110	90,5	5,00
60888	440	540	31	155	285	5,85	870	1000	16,5	2,00
61888 M	440	540	46	245	445	9,14	870	1000	22	2,10
60988	440	600	50	305	550	10,96	870	1000	41	4,00
61988 M	440	600	74	400	720	14,35	900	1100	59,2	4,00
6088	440	650	94	525	880	17,13	850	1000	108	6,00
61892 M	460	580	56	310	550	10,96	900	1100	34,3	3,00
61992	460	620	72	410	765	14,96	870	1100	63	4,00
61896	480	600	56	315	610	11,93	870	1100	36	3,00
6096	480	700	100	605	1130	21,15	740	900	126	6,00
608/500	500	620	37	220	445	8,55	800	950	20	2,10
618/500 M	500	620	56	330	620	11,91	800	950	37,3	3,00
619/500	500	670	78	450	860	16,16	760	900	79	5,00
60/500	500	720	100	575	1020	18,77	750	900	135	6,00
609/530	530	710	57	410	810	14,79	690	840	60	4,00
60/530	530	780	112	635	1260	22,38	670	810	188	6,00
608/560	560	680	37	220	460	8,40	710	860	30	2,10
618/560 M	560	680	56	328	525	9,58	700	850	42,7	3,00
608/600	600	730	42	260	550	9,69	670	800	41	3,00
618/600	600	730	60	345	710	12,51	670	800	52,7	3,00
608/630	630	780	48	355	765	13,10	640	760	41	3,00
609/630	630	850	71	475	1050	17,54	600	710	112	5,00
619/630	630	850	100	610	1330	22,22	600	710	163	6,00
60/630	630	920	128	800	1750	28,57	550	660	280	7,50
618/670	670	820	69	420	780	12,99	560	670	82,2	4,00
609/670	670	900	73	540	1210	19,63	580	700	143	5,00
619/670 M	670	900	103	670	1450	23,52	530	630	194	6,00
618/710	710	870	74	451	905	14,64	530	630	98,1	4
609/710	710	950	78	545	1280	20,20	500	610	148	5
619/710	710	950	106	645	1510	23,82	500	610	218	6
60/710	710	1030	140	935	2180	33,59	490	560	375	7,5
618/750	750	920	78	515	1240	19,51	480	610	110	5
619/750	750	1000	112	745	1790	27,51	490	570	260	6

Deep Groove Ball Bearing

DATA TABLE



Part number	Principal dimensions			Load ratings			Speed limits		Weight	Radius
	Bore	Outer	Width	Dynamic	Static	Fatigue	Grease	Oil		
	d	D	B	Cr	Cor	Pu	rpm		Kg	rs min
mm			kN			1 min ⁻¹				mm
60/750	750	1090	150	975	2370	35,52	450	530	490	7,5
608/800	800	980	57	390	990	15,08	430	510	100	4
618/800	800	980	82	545	1360	20,72	430	510	132	5
619/800	800	1060	115	815	2100	31,30	430	500	280	6
60/800	800	1150	155	985	2530	36,83	400	480	540	7,5
608/850	850	1030	57	385	1000	14,83	450	500	75	4
618/850	850	1030	82	555	1310	19,42	450	530	144	5
619/850	850	1120	118	815	2150	31,14	400	480	315	6
60/850	850	1220	165	1090	2980	42,10	370	430	640	7,5
618/900 CA	900	1090	85	600	1430	20,61	380	450	155	5
619/900	900	1180	122	830	2270	32,00	360	440	355	6
60/900	900	1280	170	1080	3120	42,96	330	410	725	7,5
619/950	950	1250	132	985	2850	39,06	330	410	395	7,5
60/950	950	1360	180	1145	3315	44,34	310	380	850	7,5
608/1000 M	1000	1220	71	540	1550	21,15	350	400	175	4
618/1000 M	1000	1220	100	635	1720	23,47	340	400	230	5
609/1000	1000	1320	103	800	2340	31,23	330	380	405	6
619/1000	1000	1320	140	985	2880	38,44	330	380	525	7,5
60/1000	1000	1420	185	1320	3900	50,96	280	340	925	7,5
618/1060	1060	1280	100	710	2140	28,44	310	350	265	6
619/1060	1060	1400	150	985	3030	39,27	290	330	615	7,5
60/1060	1060	1500	195	1320	3860	49,04	250	330	1090	9,5
618/1120	1120	1360	106	725	2180	28,14	290	350	310	6
619/1120	1120	1460	150	1010	3070	38,85	270	330	640	7,5
60/1120	1120	1580	200	1430	4480	55,42	250	300	1245	9,5
619/1180	1180	1540	160	1115	3630	44,74	210	270	765	7,5
618/1250	1250	1500	112	830	2740	33,59	210	270	390	6
609/1320	1320	1720	128	1180	4060	47,33	190	230	835	7,5
618/1400	1400	1700	132	1070	3980	45,95	190	230	620	7,5
619/1400	1400	1820	185	1550	5520	62,53	180	230	1260	9,5
618/1500	1500	1820	140	1190	4310	48,08	170	210	695	7,5
619/1500	1500	1950	195	1680	6220	68,07	160	190	1515	9,5
618/1600	1600	1950	155	1240	4750	51,25	150	180	975	7,5
619/1600	1600	2060	200	1820	6880	73,10	140	170	1660	9,5
618/1700	1700	2060	160	1240	4950	51,89	130	160	1110	7,5

TECHNICAL NOTEBOOK

ROLLWAY®

DEEP GROOVE BALL BEARING

STAINLESS STEEL

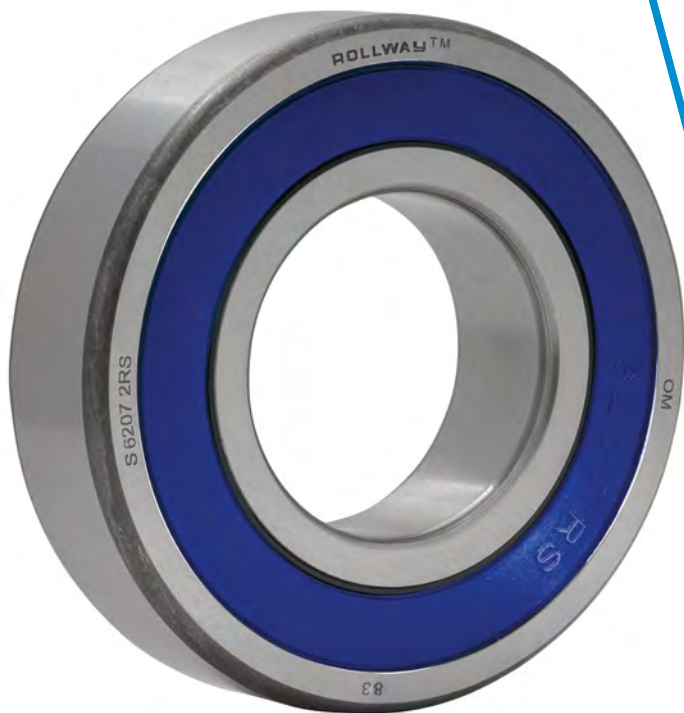

In this section:

Page

Design Characteristics Applications Angular Misalignment	
ISO Specification Series	30
Nomenclature Equivalent Load Equations Lubrication	
Radial Clearance Table	31
Data Tables	32-34

Deep Groove Ball Bearing

STAINLESS STEEL

DESIGN | CHARACTERISTICS | APPLICATIONS

The stainless steel single row deep groove ball bearing is a variant of the standard bearing. Hence, the bearing is made from special stainless steel AISI 412. This steel grade assures good hardenability and a good resistance against corrosion.

The stainless steel version can be identified with a prefix S and is only available with 2 seals suffix 2RS.

This stainless steel bearing is specially made to operate in humid or wet environments, like agriculture, food processing, sea-side applications.

The lubrication is similar to the standard deep groove ball bearing. For food processing application, a food grade grease is required. Contact Regal Beloit Belgium for more details.



S6205 2RS

ANGULAR MISALIGNMENT

The following is an approximate guide to the misalignment that can be accommodated in the use of a single row ball bearing:

0.0010 radians

ISO SPECIFICATIONS

- Dimensions in accordance with ISO 15 (latest version)
- Precision class in accordance with ISO 492 (latest version)
- Radial clearance in accordance with ISO 5753 (latest version)

SERIES

Standard series are S 6000 | S 6200 | S 6300.

Other series are available on special request.

Contact Regal Beloit Belgium for more details.

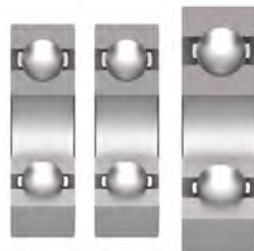

S6000

S6200

S6300

NOMENCLATURE

Prefixes:

S : Stainless steel bearing, sealed and lubricated for life time

Suffixes:

2RS : 2 NBR seals, filled with Lithium base grease

Peak operating temperature is 100°C

C2 - C3 : Radial clearance class

P0 : Precision class

V2 : Noise level class whereas V3 is quieter than V2

EQUIVALENT LOAD EQUATIONS

Refer to the deep groove ball bearing paragraph for the equivalent load calculation methods.

SEALS

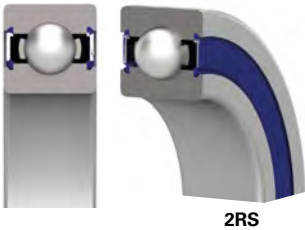

2RS

The contact seals (2RS) are made from NBR - Nitril Butadiene Rubber. The rubber withstands operating temperatures of 100°C max. They are reinforced with a stainless steel washer inside.

Sealed bearings have a lower maximum speed due to the contact between the seal lips and the inner ring. This contact will generate heat which will reduce the speed limit of -20% compared to an open or shielded bearing.

LUBRICATION

Standard sealed bearings are lubricated with Lithium based grease and with a fill rate of 30%. The viscosity is 120 ISO VG. For food grade applications, a dedicated food grade grease is used.

RADIAL CLEARANCE TABLE

Bore diameter		Clearance class			
d (mm)		CN (µm)		C3 (µm)	
over	up to	min.	max.	min.	max.
2,5	10	2	13	8	23
10	18	3	18	11	25
18	24	5	20	13	28
24	30	5	20	13	28
30	40	6	20	15	33
40	50	6	23	18	36
50	65	8	28	23	43
65	80	10	30	25	51
80	100	12	36	30	58
100	120	15	41	36	66



Deep Groove Ball Bearing

DATA TABLE - STAINLESS STEEL

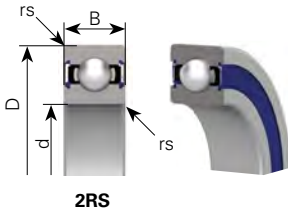

Part number	Principal dimensions			Load ratings			Speed limits		Weight	Radius
	Bore	Outer	Width	Dynamic	Static	Fatigue	Grease	Oil		
	d	D	B	Cr	Cor	Pu	rpm		Kg	rs min mm
	mm			kN			1 min ⁻¹			
S685 2RS	5	11	3	0,72	0,28	0,01	43000		0,0011	0,15
S695 2RS	5	13	4	1,08	0,43	0,02	40000		0,0024	0,20
S605 2RS	5	14	5	1,33	0,51	0,02	39000		0,0035	0,20
S625 2RS	5	16	5	1,76	0,68	0,03	37000		0,0048	0,30
S635 2RS	5	19	6	2,34	0,89	0,04	34000		0,0080	0,30
S686 2RS	6	13	4	1,08	0,44	0,02	39000		0,0019	0,15
S696 2RS	6	15	5	1,35	0,53	0,02	37000		0,0038	0,20
S606 2RS	6	17	6	2,19	0,87	0,04	35000		0,0060	0,30
S626 2RS	6	19	6	2,34	0,89	0,04	34000		0,0080	0,30
S636 2RS	6	22	7	3,30	1,35	0,06	31000		0,0130	0,30
S687 2RS	7	14	4	1,17	0,51	0,02	37000		0,0021	0,15
S697 2RS	7	17	5	1,61	0,72	0,03	35000		0,0052	0,30
S607 2RS	7	19	6	2,24	0,91	0,04	34000		0,0080	0,30
S627 2RS	7	22	7	3,35	1,40	0,06	32000		0,0130	0,30
S637 2RS	7	26	9	4,55	1,95	0,09	26000		0,0240	0,30
S688 2RS	8	16	4	1,26	0,59	0,03	35000		0,0031	0,20
S698 2RS	8	19	6	1,99	0,87	0,04	33000		0,0073	0,30
S608 2RS	8	22	7	3,35	1,40	0,06	32000		0,0120	0,30
S628 2RS	8	24	8	4,00	1,59	0,07	31000		0,0170	0,30
S638 2RS	8	28	9	4,55	1,95	0,09	26000		0,0290	0,30
S689 2RS	9	17	4	1,72	0,82	0,04	33000		0,0032	0,20
S699 2RS	9	20	6	2,48	1,09	0,05	32000		0,0082	0,30
S609 2RS	9	24	7	3,40	1,45	0,07	31000		0,0140	0,30
S629 2RS	9	26	8	4,55	1,96	0,09	30000		0,0200	0,30
S639 2RS	9	30	10	6,00	2,65	0,12	24000		0,0350	0,30
S6800 2RS	10	19	5	1,83	0,93	0,04	32000		0,0050	0,30
S6900 2RS	10	22	6	2,70	1,27	0,06	30000		0,0090	0,30
S6000 2RS	10	26	8	4,55	1,96	0,09	29000		0,0190	0,30
S6200 2RS	10	30	9	5,10	2,39	0,11	25000		0,0320	0,60
S6300 2RS	10	35	11	8,20	3,50	0,16	23000		0,0530	0,60
S6801 2RS	12	21	5	1,92	1,04	0,05	29000		0,0060	0,30
S6901 2RS	12	24	6	2,89	1,46	0,07	27000		0,0110	0,30
S6001 2RS	12	28	8	5,10	2,39	0,11	26000		0,0210	0,30
S6201 2RS	12	32	10	6,10	2,75	0,13	22000		0,0370	0,60
S6301 2RS	12	37	12	9,70	4,20	0,19	20000		0,0600	1,00

Deep Groove Ball Bearing

DATA TABLE - STAINLESS STEEL



Part number	Principal dimensions			Load ratings			Speed limits		Weight	Radius
	Bore	Outer	Width	Dynamic	Static	Fatigue	Grease	Oil		
	d	D	B	Cr	Cor	Pu	rpm		Kg	rs min mm
	mm			kN			1 min ⁻¹			
S6802 2RS	15	24	5	2,08	1,26	0,06	26000	0,0070	0,30	
S6902 2RS	15	28	7	4,10	2,06	0,09	24000	0,0160	0,30	
S6002 2RS	15	32	9	5,60	2,84	0,13	22000	0,0300	0,30	
S6202 2RS	15	35	11	7,75	3,60	0,16	19000	0,0450	0,60	
S6302 2RS	15	42	13	11,40	5,45	0,25	17000	0,0820	1,00	
S6803 2RS	17	26	5	2,81	1,72	0,08	24000	0,0080	0,30	
S6903 2RS	17	30	7	4,65	2,58	0,12	22000	0,0180	0,30	
S6003 2RS	17	35	10	6,80	3,35	0,15	20000	0,0390	0,30	
S6203 2RS	17	40	12	9,60	4,60	0,21	18000	0,0660	0,60	
S6303 2RS	17	47	14	13,50	6,55	0,30	16000	0,1150	1,00	
S6804 2RS	20	32	7	4,00	2,47	0,11	21000	0,0190	0,30	
S6904 2RS	20	37	9	6,40	3,70	0,17	19000	0,0360	0,30	
S6004 2RS	20	42	12	9,40	5,05	0,23	18000	0,0690	0,60	
S6204 2RS	20	47	14	12,80	6,65	0,30	16000	0,1106	1,00	
S6304 2RS	20	52	15	15,90	7,90	0,36	14000	0,1440	1,10	
S6805 2RS	25	37	7	4,30	2,95	0,13	18000	0,0220	0,30	
S6905 2RS	25	42	9	7,05	4,55	0,21	16000	0,0420	0,30	
S6005 2RS	25	47	12	10,10	5,85	0,27	15000	0,0800	0,60	
S6205 2RS	25	52	15	14,00	7,85	0,36	13000	0,1280	1,00	
S6305 2RS	25	62	17	21,20	10,90	0,50	12000	0,2320	1,10	
S6806 2RS	30	42	7	4,70	3,65	0,17	15000	0,0260	0,30	
S6906 2RS	30	47	9	7,25	5,00	0,23	14000	0,0480	0,30	
S6006 2RS	30	55	13	13,20	8,30	0,38	13000	0,1160	1,00	
S6206 2RS	30	62	16	19,50	11,30	0,51	11000	0,1990	1,00	
S6306 2RS	30	72	19	26,70	15,00	0,68	10000	0,3500	1,10	
S6807 2RS	35	47	7	4,90	4,05	0,18	13000	0,0290	0,30	
S6907 2RS	35	55	10	11,20	7,45	0,34	12000	0,0740	0,60	
S6007 2RS	35	62	14	16,00	10,30	0,47	12000	0,1550	1,00	
S6207 2RS	35	72	17	25,70	15,30	0,70	9800	0,2880	1,10	
S6307 2RS	35	80	21	33,50	19,10	0,87	8800	0,4570	1,50	
S6808 2RS	40	52	7	5,10	4,40	0,20	12000	0,0330	0,30	
S6908 2RS	40	62	12	14,60	10,20	0,46	11000	0,1100	0,60	
S6008 2RS	40	68	15	16,80	11,50	0,52	10000	0,1900	1,00	
S6208 2RS	40	80	18	29,10	17,80	0,81	8700	0,3366	1,10	
S6308 2RS	40	90	23	40,50	24,00	1,09	7800	0,6300	1,50	

Deep Groove Ball Bearing

DATA TABLE - STAINLESS STEEL

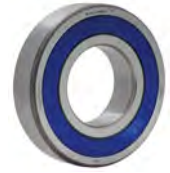
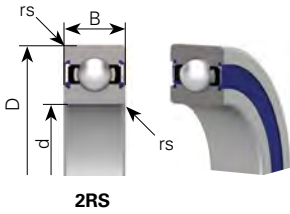

Part number	Principal dimensions			Load ratings			Speed limits		Weight	Radius
	Bore	Outer	Width	Dynamic	Static	Fatigue	Grease	Oil		
	d	D	B	Cr	Cor	Pu	rpm		Kg	rs min
mm			kN			1 min ⁻¹		mm		
S6809 2RS	45	58	7	6,40	5,65	0,26	11000	0,0400	0,30	
S6909 2RS	45	68	12	15,10	11,20	0,51	9800	0,1280	0,60	
S6009 2RS	45	75	16	21,00	15,10	0,69	9200	0,2370	1,00	
S6209 2RS	45	85	19	32,50	20,40	0,93	7800	0,3980	1,10	
S6309 2RS	45	100	25	53,00	32,00	1,45	7000	0,8140	1,50	
S6810 2RS	50	65	7	6,60	6,10	0,28	9600	0,0520	0,30	
S6910 2RS	50	72	12	15,60	12,20	0,55	8900	0,1320	0,60	
S6010 2RS	50	80	16	21,80	16,60	0,75	8400	0,2610	1,00	
S6210 2RS	50	90	20	35,00	23,20	1,05	7100	0,4540	1,10	
S6310 2RS	50	110	27	62,00	38,50	1,75	6400	1,0700	2,00	
S6811 2RS	55	72	9	8,80	8,10	0,37	8700	0,0830	0,30	
S6911 2RS	55	80	13	16,00	13,30	0,60	8200	0,1800	1,00	
S6011 2RS	55	90	18	28,30	21,20	0,96	7700	0,3880	1,10	
S6211 2RS	55	100	21	43,50	29,20	1,33	6400	0,6010	1,50	
S6311 2RS	55	120	29	71,50	45,00	2,05	5800	1,3700	2,00	
S6812 2RS	60	78	10	11,50	10,60	0,48	8000	0,1060	0,30	
S6912 2RS	60	85	13	16,40	14,30	0,65	7600	0,1930	1,00	
S6012 2RS	60	95	18	31,60	24,20	1,10	7000	0,4140	1,10	
S6212 2RS	60	110	22	52,50	36,00	1,64	6000	0,7830	1,50	
S6913 2RS	65	90	13	17,40	16,10	0,73	7000	0,2060	1,00	
S6813 2RS	65	85	10	11,60	11,00	0,50	7400	0,1280	0,60	
S6013 2RS	65	100	18	30,50	25,20	1,15	6500	0,4210	1,10	
S6213 2RS	65	120	23	57,50	40,00	1,82	5500	0,9900	1,50	
S6814 2RS	70	90	10	12,10	11,90	0,54	6900	0,1370	0,60	
S6914 2RS	70	100	16	23,70	21,20	0,96	6500	0,3340	1,00	
S6014 2RS	70	110	20	38,00	31,00	1,41	6100	0,6040	1,10	
S6815 2RS	75	95	10	12,50	12,90	0,59	6400	0,1450	0,60	
S6915 2RS	75	105	16	24,40	22,60	1,03	6100	0,3530	1,00	
S6816 2RS	80	100	10	12,70	13,30	0,60	6000	0,1540	0,60	
S6916 2RS	80	110	16	24,90	24,00	1,09	5700	0,3730	1,00	

TECHNICAL NOTEBOOK

SELF-ALIGNING BALL BEARING

DOUBLE ROW

ROLLWAY®



In this section:

	Page
Design Characteristics Applications	36
Angular Misalignment ISO Specification Series Nomenclature	37
Equivalent Load Equations Axial Loading Capacity Seals Lubrication	38
Clearance Tables	39-40
Data Tables	41-43

REGAL®

Self-Aligning Ball Bearing

DESIGN | CHARACTERISTICS | APPLICATIONS

This design of bearing utilizes two rows of balls with the inner ring having two deep groove raceways while the outer ring has a single continuous spherical raceway. This permits the inner and outer ring to be misaligned relative to each other through a comparatively large angle without imposing moment loads upon the balls.

These bearings are also manufactured with tapered bore.

This is frequently used when the inner ring is to be mounted upon an adapter sleeve or when conditions in the machine make it difficult to assure accurate alignment of the inner and outer rings. Due to the small contact angle, the thrust capacity of these bearings is limited.



With Cylindrical Bore



With Tapered Bore



With Seals



With Adapter Sleeve



ANGULAR MISALIGNMENT

The following is an approximate guide to the misalignment that can be accommodated in a double row self-aligning ball bearing.

Maximum permitted misalignment in degrees.

Bearing series	Maximum inclination in degrees
108, 126, 127, 129, 135	3°
Series 12	2.5°
Series 13	3°
Series 22	2.5°
Series 22-2RS	1.5°
Series 23	3°
Series 23-2RS	1.5°

ISO SPECIFICATIONS

- Dimensions in accordance with ISO 15 (latest version)
- Precision class in accordance with ISO 492 (latest version)
- Radial clearance in accordance with ISO 5753 (latest version)

SERIES

The standard series are 1000 | 1200 | 1300 | 2200 | 2300.

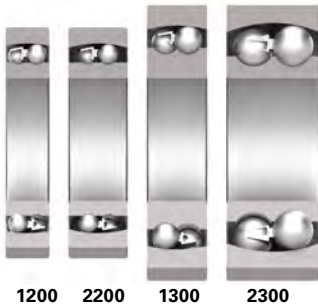

NOMENCLATURE

Suffixes:

2RS : 2 NBR seals, filled with Lithium base grease.

Peak operating temperature is 100°C

K : 1/12 Tapered bore

P0 - P6 : Precision class

C0 - C3 : Radial clearance C3 is wider than C0

Self-Aligning Ball Bearing

EQUIVALENT LOAD EQUATIONS

Equivalent dynamic load

$$P = Fr + Y_1 Fa \quad \text{when} \quad Fa/Fr \leq e$$

$$P = 0.65 Fr + Y_2 Fa \quad \text{when} \quad Fa/Fr > e$$

The values for Y_1 , Y_2 and e are given in the bearing tables.

Equivalent static load

$$Po = Fr + Y_0 Fa$$

The Y_0 values are given in the bearing tables.

AXIAL LOAD CAPACITY WHEN MOUNTED ON ADAPTER SLEEVES

When double row self-aligning ball bearing are mounted on adapter sleeves fitted on smooth shafts, the axial load the bearing will depend on the friction between the sleeve bore and the shaft.

The allowable axial load can be calculated by the formula $F_{az} = 3 \cdot B \cdot d$

where: F_{az} = maximum allowable axial load [N]

B = bearing width [mm]

d = bore diameter [mm]

SEALS

The contact seals (2RS) are made from NBR - Nitril Butadiene Rubber. The rubber withstands operating temperatures of 100°C max. They are reinforced with a metallic washer inside.

The bearings are pre-lubricated with the correct grease quantity.

Sealed bearings have a lower maximum speed due to the contact between the seal lips and the inner ring. This contact will generate heat which will reduce the speed limit of -20% compared to an open or shielded bearing.



2RS

LUBRICATION

Sealed bearings are lubricated with a Lithium based grease and with a fill rate of 30%. The viscosity is 100 ISO VG.

RADIAL CLEARANCE TABLES

For cylindrical bore



Bore diameter		Clearance class									
d		C2		CN		C3		C4		C5	
mm		µm		µm		µm		µm		µm	
over	up to	min.	max.	min.	max.	min.	max.	min.	max.	min.	max.
2,5	10	0	7	2	13	8	23	14	29	20	37
10	18	0	9	3	18	11	25	18	33	25	45
18	24	0	10	5	20	13	28	20	36	28	48
24	30	1	11	5	20	13	28	23	41	30	53
30	40	1	11	6	20	15	33	28	46	40	64
40	50	1	11	6	23	18	36	30	51	45	73
50	65	1	15	8	28	23	43	38	61	55	90
65	80	1	15	10	30	25	51	46	71	65	105
80	100	1	18	12	36	30	58	53	84	75	120
100	120	2	20	15	41	36	66	61	97	90	140
120	140	2	23	18	48	41	81	71	114	105	160
140	160	2	23	18	53	46	91	81	130	120	180
160	180	2	25	20	61	53	102	91	147	135	200
180	200	2	30	25	71	63	117	107	163	150	230
200	225	2	35	25	85	75	140	125	195	175	265
225	250	2	40	30	95	85	160	145	225	205	300
250	280	2	45	35	105	90	170	155	245	225	340
280	315	2	55	40	115	100	190	175	270	245	370
315	355	3	60	45	125	110	210	195	300	275	410
355	400	3	70	55	145	130	240	225	340	315	460
400	450	3	80	60	170	150	270	250	380	350	510
450	500	3	90	70	190	170	300	280	420	390	570
500	560	10	100	80	210	190	333	310	470	440	630
560	630	10	110	90	230	210	360	340	520	490	690
630	710	20	130	110	260	240	400	380	570	540	780
710	800	20	140	120	290	270	450	430	630	600	840
800	900	20	160	140	320	300	500	480	700	670	940
900	1000	20	170	150	350	330	550	530	770	740	1040
1000	1120	20	180	160	380	360	600	580	850	820	1150
1120	1250	20	190	170	410	390	650	630	920	890	1260
1250	1400	30	220	200	450	430	710	680	1100	980	1380

Self-Aligning Ball Bearing

RADIAL CLEARANCE TABLES For tapered bore



Bore diameter		Clearance class							
d		C2		CN		C3		C4	
mm		µm		µm		µm		µm	
over	up to	min.	max.	min.	max.	min.	max.	min.	max.
2,5	10	2	13	8	23	14	29	20	37
10	18	3	18	11	25	18	33	25	45
18	24	5	20	13	28	20	36	28	48
24	30	5	20	13	28	23	41	30	53
30	40	6	20	15	33	28	46	40	64
40	50	6	23	18	36	30	51	45	73
50	65	8	28	23	43	38	61	55	90
65	80	10	30	25	51	46	71	65	105
80	100	12	36	30	58	53	84	75	120
100	120	15	41	36	66	61	97	90	140
120	140	18	48	41	81	71	114	105	160
140	160	18	53	46	91	81	130	120	180
160	180	20	61	53	102	91	147	135	200
180	200	25	71	63	117	107	163	150	230
200	225	25	85	75	140	125	195	175	265
225	250	30	95	85	160	145	225	205	300
250	280	35	105	90	170	155	245	225	340
280	315	40	115	100	190	175	270	245	370
315	355	45	125	110	210	195	300	275	410
355	400	55	145	130	240	225	340	315	460
400	450	60	170	150	270	250	380	350	510
450	500	70	190	170	300	280	420	390	570
500	560	80	210	190	333	310	470	440	630
560	630	90	230	210	360	340	520	490	690
630	710	110	260	240	400	380	570	540	780
710	800	120	290	270	450	430	630	600	840
800	900	140	320	300	500	480	700	670	940
900	1000	150	350	330	550	530	770	740	1040
1000	1120	160	380	360	600	580	850	820	1150
1120	1250	170	410	390	650	630	920	890	1260
1250	1400	200	450	430	710	680	1100	980	1380

Self-Aligning Ball Bearing

DATA TABLE

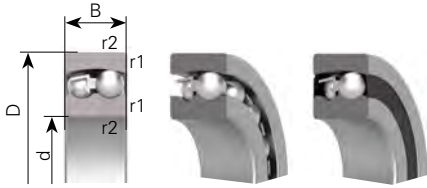

SEAL | 2RS



Part number	Principal dimensions			Load ratings			Speed limits		Weight	Dimensions	Calculation factors			
	Bore	Outer	Width	Dynamic	Static	Fatigue	Grease	Oil			r1/r2	e	Y1	Y2
	d	D	B	Cr	Cor	Pu	rpm	1 min ⁻¹	mm	mm				
135	5	19	6	2,55	0,48	0,02	30000	36000	0,01	0,3	0,33	1,9	3	2
126	6	19	6	2,5	0,48	0,02	30000	36000	0,01	0,3	0,33	1,9	3	2
127	7	22	7	2,65	0,56	0,03	30000	36000	0,018	0,3	0,33	1,9	3	2
108	8	22	7	2,65	0,56	0,03	30000	36000	0,218	0,3	0,33	1,9	3	2
129	9	26	8	3,8	0,8	0,04	26000	32000	0,02	0,6	0,33	1,9	3	2
1200	10	30	9	5,5	1,2	0,05	24000	30000	0,03	0,6	0,33	1,9	3	2
1300	10	35	11	7,2	1,6	0,07	20000	26000	0,062	0,6	0,34	1,9	2,9	1,9
2200	10	30	14	7,2	1,6	0,07	22000	28000	0,04	0,6	0,54	1,2	1,8	1,2
1201	12	32	10	5,6	1,25	0,06	22000	28000	0,04	0,6	0,37	1,7	2,6	1,8
1301	12	37	12	9,4	2,15	0,10	18000	22000	0,06	1	0,35	1,8	2,8	1,9
2201	12	32	14	7,6	1,75	0,08	20000	26000	0,05	0,6	0,53	1,2	1,8	1,2
2301	12	37	17	9,4	2,3	0,10	17000	20000	0,09	1	0,54	1,2	1,8	1,2
1202	15	35	11	7,5	1,75	0,08	19000	24000	0,049	0,6	0,36	1,8	2,7	1,9
1302	15	42	13	9,55	2,3	0,10	17000	20000	0,09	1	0,35	1,8	2,8	1,9
2202	15	35	14	7,7	1,85	0,08	18000	22000	0,06	0,6	0,5	1,3	2	1,3
2302	15	42	17	12,1	2,9	0,13	15000	18000	0,11	1	0,5	1,3	2	1,3
1203	17	40	12	7,9	2,05	0,09	18000	22000	0,07	0,6	0,32	1,9	3	2
1303	17	47	14	12,5	3,15	0,14	14000	17000	0,13	1	0,34	1,8	2,9	2
2203	17	40	16	9,8	2,4	0,11	17000	20000	0,08	0,6	0,5	1,3	2	1,3
2303	17	47	19	14,5	3,6	0,16	13000	16000	0,16	1	0,49	1,3	2	1,3
1204	20	47	14	9,9	2,65	0,12	15000	18000	0,120	1,0	0,28	2,2	3,5	2,4
1304	20	52	15	12,4	3,35	0,15	12000	15000	0,160	1,1	0,30	2,1	3,3	2,2
2204	20	47	18	12,6	3,30	0,15	14000	17000	0,140	1,0	0,28	2,2	3,5	2,4
2304	20	52	21	18,2	4,70	0,21	11000	14000	0,210	1,1	0,52	1,2	1,9	1,3
1205	25	52	15	12,2	3,30	0,15	13000	16000	0,140	1,0	0,29	2,2	3,4	2,3
1305	25	62	17	17,8	4,90	0,22	9500	12000	0,260	1,1	0,28	2,2	3,5	2,4
2205 2RS	25	52	18	12,2	3,30	0,15	7000		0,160	1,0	0,29	2,2	3,4	2,3
2205	25	52	18	12,5	3,45	0,16	11000	14000	0,160	1,0	0,43	1,5	2,3	1,6
2305 2RS	25	62	24	17,8	4,90	0,22	6300		0,330	1,1	0,28	2,2	3,5	2,4
2305	25	62	24	24,5	6,55	0,30	9500	12000	0,340	1,1	0,44	1,4	2,2	1,5
1206	30	62	16	15,7	4,70	0,21	10000	13000	0,220	1,0	0,25	2,5	3,9	2,7
1306	30	72	19	21,4	6,35	0,29	9000	11000	0,380	1,1	0,24	2,6	4,1	2,8
2206 2RS	30	62	20	15,7	4,70	0,21	5300		0,260	1,0	0,25	2,5	3,9	2,7
2206	30	62	20	15,3	4,60	0,21	9500	12000	0,260	1,0	0,40	1,6	2,5	1,7
2306 2RS	30	72	27	21,4	6,35	0,29	5600		0,500	1,1	0,24	2,6	4,1	2,8
2306	30	72	27	31,4	8,70	0,40	8500	10000	0,500	1,1	0,40	1,6	2,5	1,7

Self-Aligning Ball Bearing

DATA TABLE

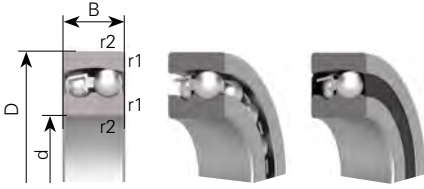

SEAL | 2RS

Part number	Principal dimensions			Load ratings			Speed limits		Weight	Dimensions	Calculation factors			
	Bore	Outer	Width	Dynamic	Static	Fatigue	Grease	Oil			r1/r2	e	Y1	Y2
	d	D	B	Cr	Cor	Pu	rpm		Kg	mm	mm			
	mm			kN			1 min ⁻¹							
1207	35	72	17	15,8	5,15	0,23	9000	11000	0,320	1,1	0,23	2,8	4,2	2,9
1307	35	80	21	25,1	7,95	0,36	7500	9000	0,510	1,5	0,25	2,5	3,9	2,7
2207 2RS	35	72	23	15,8	5,15	0,23	5600		0,400	1,1	0,23	2,8	4,2	2,9
2207	35	72	23	21,7	6,70	0,30	8500	10000	0,400	1,1	0,37	1,7	2,6	1,8
2307 2RS	35	80	31	25,1	7,95	0,36	4500		0,670	1,5	0,25	2,5	3,9	2,7
2307	35	80	31	39,7	12,90	0,59	7000	8500	0,670	1,5	0,43	1,5	2,3	1,6
1208	40	80	18	19,2	6,50	0,30	8500	10000	0,410	1,1	0,22	2,9	4,5	3,0
1308	40	90	23	29,5	9,75	0,44	6700	8000	0,710	1,5	0,24	2,6	4,1	2,8
2208 2RS	40	80	23	19,2	6,50	0,30	4800		0,500	1,1	0,22	2,9	4,5	3,0
2208	40	80	23	22,4	7,40	0,34	7500	9000	0,500	1,1	0,33	1,9	3,0	2,0
2308 2RS	40	90	33	29,5	9,75	0,44	4000		0,920	1,5	0,24	2,6	4,1	2,8
2308	40	90	33	44,9	15,10	0,69	6300	7500	0,920	1,5	0,39	1,6	2,5	1,7
1209	45	85	19	21,8	7,40	0,34	7500	9000	0,460	1,1	0,21	3,0	4,7	3,2
1309	45	100	25	37,7	12,90	0,59	6300	7500	0,950	1,5	0,24	2,6	4,1	2,8
2209 2RS	45	85	23	21,8	7,40	0,34	4500		0,540	1,1	0,21	3,0	4,7	3,2
2209	45	85	23	23,3	8,15	0,37	7000	8500	0,540	1,1	0,31	2,0	3,1	2,1
2309 2RS	45	100	36	37,7	12,90	0,59	3600		1,230	1,5	0,24	2,6	4,1	2,8
2309	45	100	36	54,1	16,50	0,75	5600	6700	1,230	1,5	0,31	2,0	3,1	2,1
1210	50	90	20	22,9	8,10	0,37	7000	8500	0,520	1,1	0,21	3,0	4,7	3,2
1310	50	110	27	43,4	14,20	0,65	5600	6700	1,210	2,0	0,24	2,6	4,1	2,8
2210 2RS	50	90	23	22,9	8,10	0,37	4000		0,590	1,1	0,21	3,0	4,6	3,2
2210	50	90	23	23,3	8,50	0,39	6300	7500	0,590	1,1	0,29	2,2	3,4	2,3
2310 2RS	50	110	40	43,4	14,20	0,65	3400		1,640	2,0	0,24	2,6	4,1	2,8
2310	50	110	40	64,4	20,00	0,91	5300	6300	1,650	2,0	0,42	1,5	2,3	1,6
1211	55	100	21	26,6	10,10	0,46	6300	7500	0,700	1,5	0,20	3,2	4,9	3,3
1311	55	120	29	51,3	18,10	0,82	5000	6000	1,580	2,0	0,23	2,3	4,2	2,9
2211	55	100	25	26,5	9,90	0,45	6000	7000	0,810	1,5	0,27	2,3	3,6	2,5
2311	55	120	43	75,3	23,80	1,08	4800	5600	2,100	2,0	0,41	1,5	2,4	1,6
1212	60	110	22	30,2	11,60	0,53	5600	6700	0,900	1,5	0,19	3,4	5,2	3,5
1312	60	130	31	57,1	20,80	0,95	4500	5300	1,960	2,1	0,23	2,8	4,2	2,9
2212	60	110	28	33,8	12,60	0,57	5300	6300	1,100	1,5	0,28	2,2	3,5	2,4
2312	60	130	46	87,1	28,00	1,27	4300	5000	2,600	2,1	0,41	1,5	2,4	1,6

Self-Aligning Ball Bearing

DATA TABLE



Part number	Principal dimensions			Load ratings			Speed limits		Weight	Dimensions	Calculation factors			
	Bore	Outer	Width	Dynamic	Static	Fatigue	Grease	Oil			r1/r2	e	Y1	Y2
	d	D	B	Cr	Cor	Pu	rpm		Kg	mm				
	mm			kN			1 min ⁻¹							
1213	65	120	23	31,0	12,40	0,56	5300	6300	1,150	1,5	0,17	3,7	5,7	3,9
1313	65	140	33	62,0	22,90	1,03	4300	5000	2,450	2,1	0,23	2,8	4,2	2,8
2213	65	120	31	43,6	16,40	0,75	5000	6000	1,450	1,5	0,28	2,2	3,5	2,4
2313	65	140	48	95,6	32,50	1,46	4000	4800	3,250	2,1	0,38	1,7	2,6	1,7
1214	70	125	24	34,6	13,70	0,62	5000	6000	1,250	1,5	0,18	3,5	5,4	3,7
1314	70	150	35	74,1	27,70	1,20	4000	4800	3,000	2,1	0,22	2,9	4,5	3,0
2214	70	125	31	44,2	17,10	0,78	4800	5600	1,500	1,5	0,27	2,3	3,6	2,5
2314	70	150	51	111,0	31,70	1,37	3600	4300	3,900	2,1	0,35	1,8	2,8	1,9
1215	75	130	25	38,9	15,60	0,70	4800	5600	1,350	1,5	0,18	3,5	5,4	3,7
1315	75	160	37	79,2	30,00	1,26	3600	4300	3,550	2,1	0,22	2,9	4,5	3,0
2215	75	130	31	44,0	17,80	0,80	4500	5300	1,600	1,5	0,25	2,5	3,9	2,7
2315	75	160	55	123,0	42,80	1,79	3400	4000	4,700	2,1	0,38	1,7	2,6	1,7
1216	80	140	26	39,8	17,00	0,74	4300	5000	1,650	2,0	0,16	3,9	6,1	4,1
1316	80	170	39	88,4	33,00	1,34	3400	4000	4,200	2,1	0,22	2,9	4,5	3,0
2216	80	140	33	48,8	19,90	0,86	4000	4800	2,000	2,0	0,26	2,4	3,7	2,5
2316	80	170	58	136,0	48,50	1,97	3200	3800	6,100	2,1	0,34	1,9	2,9	2,0
1217	85	150	28	48,2	20,80	0,87	4000	4800	2,050	2,0	0,17	3,7	5,7	3,9
1317	85	180	41	97,5	37,90	1,50	3200	4800	5,000	3,0	0,22	2,9	4,5	3,0
2217	85	150	36	58,5	23,80	1,00	3800	4800	2,500	2,0	0,25	2,5	3,9	2,7
2317	85	180	60	140,0	51,50	2,03	3000	3600	7,050	3,0	0,37	1,7	2,6	1,8
1218	90	160	30	57,0	23,10	0,94	3800	4500	2,500	2,0	0,17	3,7	5,7	3,9
1318	90	190	43	117,0	44,50	1,71	3000	3600	5,800	3,0	0,22	2,9	4,5	3,0
2218	90	160	40	70,2	27,20	1,11	3600	4300	3,400	2,0	0,27	2,3	3,6	2,5
2318	90	190	64	153,0	57,70	2,22	2800	3400	8,450	3,0	0,38	1,7	2,6	1,7
1219	95	170	32	63,7	24,30	0,96	3400	4000	3,100	2,1	0,17	3,7	5,7	3,9
1319	95	200	45	133,0	50,80	1,90	2800	3400	6,700	3,0	0,23	2,8	4,2	2,9
1220	100	180	34	68,9	29,70	1,14	3200	3800	3,700	2,1	0,17	3,7	5,7	3,9
1320	100	215	47	143,0	57,30	2,08	2600	3200	8,300	3,0	0,24	2,6	4,1	2,8
2220	100	180	46	97,5	34,00	1,31	3200	3800	5,000	2,1	0,24	2,6	4,1	2,8
2320	100	215	73	193,0	73,40	2,66	2400	3000	12,200	3,0	0,34	1,9	2,9	2,0
1222	110	200	38	88,0	35,20	1,29	2800	3400	5,150	2,1	0,17	3,7	5,7	3,9
1322	110	240	50	163,0	67,50	2,32	2400	3000	12,000	3,0	0,22	2,9	4,5	3,0
2222	110	200	53	124,0	48,90	1,79	2800	3400	7,100	2,1	0,26	2,4	3,7	2,5

Notes

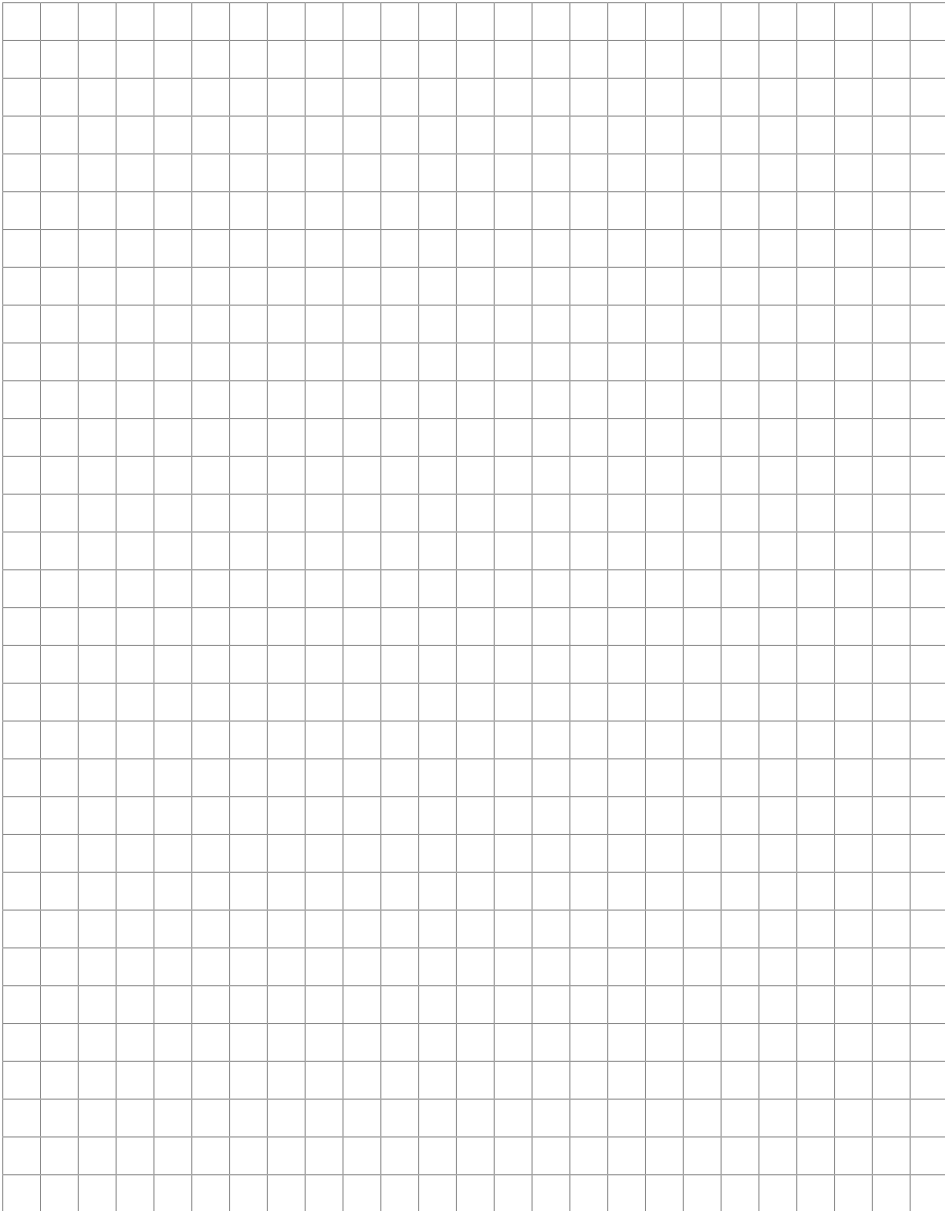

TECHNICAL NOTEBOOK

ANGULAR CONTACT BALL BEARING SINGLE ROW

ROLLWAY®



In this section:

	Page
Design Characteristics Applications	46
Bearing Arrangement.....	47
Angular Misalignment ISO Specification Series Nomenclature	48
Equivalent Load Equations.....	48-52
Axial clearance tables	52
Data Tables	53-54

REGAL®

Angular Contact Ball Bearing

SINGLE ROW

DESIGN | CHARACTERISTICS | APPLICATIONS

Single row angular contact bearings

Single row, angular contact ball bearings are non-separable bearings. These are especially designed to carry a combination of a radial load and a single direction thrust load. To carry thrust loads from opposing directions, these bearings are frequently mounted in duplex arrangement with the contact angles opposed. Paired angular contact bearings can be mounted in a variety of arrangements: "Face to Face", "Back to Back" and "Tandem" as illustrated.

Bearings are also available with universally flush ground side surfaces of the inner and outer rings for duplex mountings. Flush ground bearings are available in different preloads to give axial rigidity. They can be mounted in any of three combinations depending on the loading characteristics.

Angular contact bearings are offered in extra light, light and medium series. Each series is available in 15°, 25° and 40° contact angles to fulfill a wide variety of applications. A higher contact angle increases thrust capacity and axial rigidity but reduces radial capacity and radial rigidity. Pressed steel and machined brass cages are available to meet a variety of speed and duty requirements.



STEEL CAGE

SERIES 72 B, 73 B
CONTACT ANGLE
 $\alpha = 40^\circ$

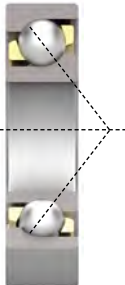

BRASS CAGE

SERIES 70 A, 72 A
CONTACT ANGLE
 $\alpha = 25^\circ$

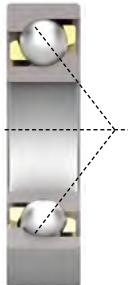

SERIES 70 C, 72 C
CONTACT ANGLE
 $\alpha = 15^\circ$

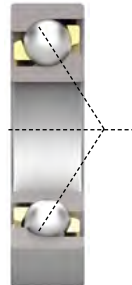

Optimum load transmission starts with $F_a \geq F_r$. Radial forces induce internal axial forces which are absorbed by the opposed bearing. Such bearings should therefore be mounted in pairs and should be adjusted against another bearing. In the case of length variations of the shaft caused by changes in temperature, which in turn, affect the internal clearance, the distance between the bearings should be kept small.

The maximum permissible speed is somewhat lower than that of deep groove ball bearings. A slight angular deflection is still possible while the single bearing; if bearings are mounted in pairs, however, rigidity greatly increases together with the ability to prevent misalignment.

BEARING ARRANGEMENT

A back-to-back arrangement (closed face together, load line of the bearings diverging towards the shaft axis) is used where rigidity and an ability to absorb fitting moment is required.

A face-to-face arrangement (open faces together, load line of the bearings converging on shaft axis) is used where axial loads acting in both directions are to be catered for by one bearing in one direction. Rigidity is not as good as the back-to-back arrangement and there is less ability to absorb fitting moments.

A tandem arrangement (open face-to-closed-face load lines being parallel to each other) is used for thrust loads equally distributed over all bearings, absorbed in one direction only. Adjustment against another bearing which accommodates the opposed thrust load is necessary.

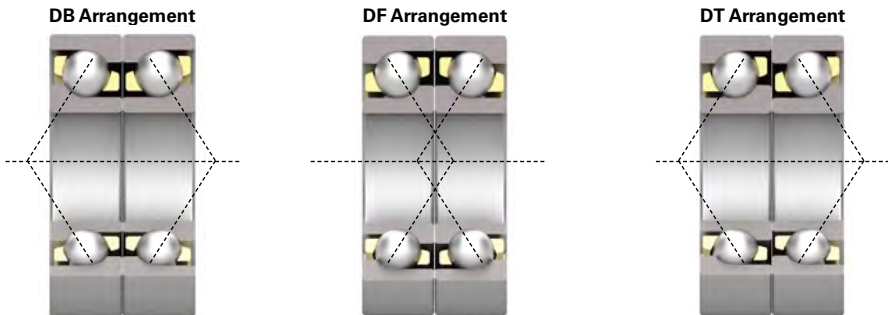
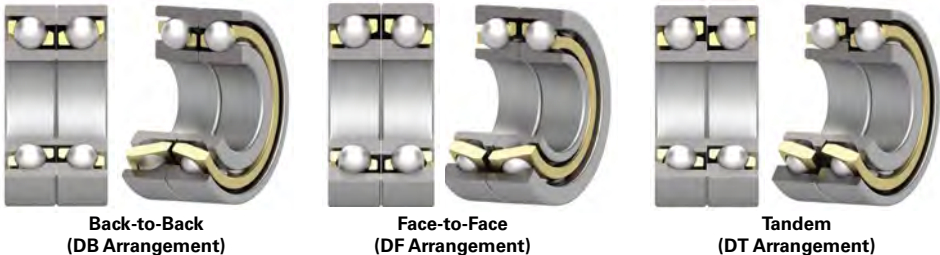

Universal match bearings can be mounted in any of three combinations depending on the loading characteristics. Suffix CB.

Angular Contact Ball Bearing

SINGLE ROW

ANGULAR MISALIGNMENT

The following is an approximate guide to the misalignment that can be prevalent when fitting angular contact bearings:

0.0003 radians

ISO SPECIFICATIONS

- Dimensions in accordance with ISO 15 (latest version)
- Precision class in accordance with ISO 492 (latest version)

SERIES

The standard series are 71800 | 71900 | 7200 | 7300 |
The standard contact angle is 40° (Suffix B)

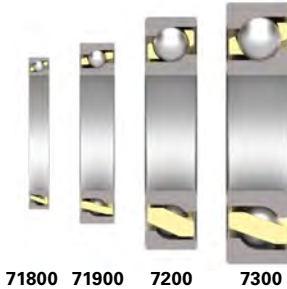

NOMENCLATURE

Suffixes:

- B : Contact angle of 40° | Is Rollway standard contact angle
- A : Contact angle of 25°
- C : Contact angle of 15°
- CB : Universal matching medium clearance | Steel cage
- CBM : Universal matching medium clearance | Brass cage
- M : Brass cage. Typically for bore size over 100 mm
- TN : Polyamide cage
- P0 - P6 : Precision class

EQUIVALENT LOAD EQUATIONS

BEARINGS WITH 40° CONTACT ANGLE

Equivalent load P_e

For single row angular contact ball bearings (series 72B and 73B) with contact angle of 40°, the following relations apply for single and tandem mounted bearings.

$$P = F \quad \text{when} \quad F_a/F_r \leq 1.14$$

$$P = 0.35 F_r + 0.57 F_a \quad \text{when} \quad F_a/F_r > 1.14$$

For bearing pairs arranged back to back or face to face:

$$P = F_r + 0.55 F_a \quad \text{when} \quad F_a/F_r \leq 1.14$$

$$P = 0.57 F_r + 0.93 F_a \quad \text{when} \quad F_a/F_r > 1.14$$

For paired bearings, F_r and F_a are the loads acting on the pair.

Since the loads are transmitted from one raceway to the other in an inclined position, radial loads induce axial reaction forces which must be considered when calculating the equivalent dynamic load. For calculation purpose the equations show where bearing A and bearing B are subjected to a radial load F_{rA} and F_{rB} respectively and are always considered positive even when they act in the opposite direction to that shown in the figures. The radial loads act at what is termed the pressure centre of the bearings which is given in the bearing tables as “a” dimension. There is an external force $K_a = 0$; the equations are valid only if the bearings have been adjusted against each other to practically zero clearance and no preload.

BEARING ARRANGEMENT AND LOAD EQUATION

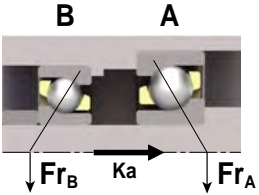

1a) $F_{rA} \geq F_{rB}$
 $K_a \geq 0$

$F_{aA} = 1.14 F_{rA}$
 $F_{aB} = F_{aA} + K_a$

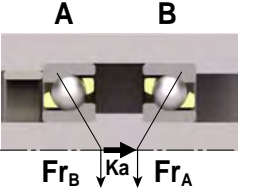

1b) $F_{rA} < F_{rB}$
 $K_a \geq 1.14 (F_{rB} - F_{rA})$

$F_{aA} = 1.14 F_{rA}$
 $F_{aB} = F_{aA} + K_a$

1c) $F_{rA} < F_{rB}$
 $K_a < 1.14 (F_{rB} - F_{rA})$

$F_{aA} = F_{aB} - K_a$
 $F_{aB} = 1.14 F_{rB}$

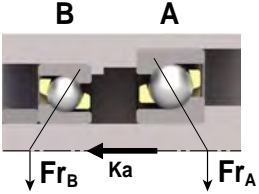

2a) $F_{rA} \leq F_{rB}$
 $K_a \geq 0$

$F_{aA} = F_{aB} + K_a$
 $F_{aB} = 1.14 F_{rB}$

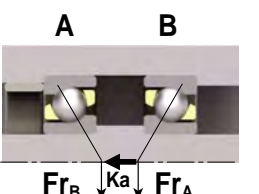

2b) $F_{rA} > F_{rB}$
 $K_a \geq 1.14 (F_{rA} - F_{rB})$

$F_{aA} = F_{aB} + K_a$
 $F_{aB} = 1.14 F_{rB}$

2c) $F_{rA} > F_{rB}$
 $K_a < 1.14 (F_{rA} - F_{rB})$

$F_{aA} = 1.14 F_{rA}$
 $F_{aB} = F_{aA} - K_a$

Angular Contact Ball Bearing

SINGLE ROW

Equivalent static load P_o

For single row angular contact ball bearings of the 72 B and 73 B series, for bearings mounted singly or paired in tandem.

$$P_o = 0.5 F_r + 0.26 F_a \quad \text{when} \quad P_o < F_r \quad P_o = F_r \text{ should be used}$$

For bearing pairs arranged back to back or face to face

$$P_o = F_r + 0.52 F_a \quad \text{when} \quad F_r \text{ and } F_a \text{ are the loads acting on the pair of bearings}$$

BEARINGS WITH 15° CONTACT ANGLE

Equivalent load P_e

Single bearings and tandem mounted bearings.

$$P = F_r \quad \text{when} \quad \frac{F_a}{F_r} \leq e$$

$$P_o = 0.44 F_r + Y F_a \quad \text{when} \quad \frac{F_a}{F_r} > e$$

The thrust factor Y and values of e are dependent on $\frac{F_a}{i C_o}$ given in tables below where C_o = static load rating [KN]

i = number of bearings

$\frac{F_a}{i \cdot C_o}$	e	Y
0.025	0.4	1.42
0.04	0.42	1.36
0.07	0.44	1.27
0.13	0.48	1.16
0.25	0.53	1.05
0.50	0.56	1

When paired back to back or face to face

$$P = F_r + Y F_a \quad \text{when} \quad \frac{F_a}{F_r} \leq e$$

$$P = 0.72 F_r + Y F_a \quad \text{when} \quad \frac{F_a}{F_r} > e$$

The thrust factor Y and values of e are dependant on $\frac{F_a}{iC_o}$ given in table below

where C_o = static load rating of the single bearing KN.

$\frac{F_a}{C_{Or}}$	e	$\frac{F_a}{F_r} \leq e$ Y_1	$\frac{F_a}{F_r} > e$ Y_2
0.025	0.4	1.6	2.3
0.04	0.42	1.5	2.2
0.07	0.44	1.4	2.1
0.13	0.48	1.3	1.9
0.25	0.53	1.2	1.7
0.50	0.56	1.1	1.6

Equivalent static load

Single bearings and tandem mounted bearings

$$P_o = F_r \quad \text{when} \quad \frac{F_a}{F_r} \leq 1.09$$

$$P_o = 0.5 F_r + 0.46 F_a \quad \text{when} \quad \frac{F_a}{F_r} > 1.09$$

For back to back and face to face arrangements:

$$P_o = F_r + 0.92 F_a$$



Angular Contact Ball Bearing

SINGLE ROW

BEARING WITH 25° CONTACT ANGLE

Equivalent load P_e

Single bearings and tandem mounted bearings.

SINGLE BEARINGS AND TANDEM MOUNTED BEARINGS

$$P = F \quad \text{when} \quad \frac{F_a}{F_r} \leq 0.68$$

$$P = 0.41 F_r + 0.87 F_a \quad \text{when} \quad \frac{F_a}{F_r} > 0.68$$

For back to back and face to face arrangements:

$$P = F_r + 0.92 F_a \quad \text{when} \quad \frac{F_a}{F_r} \leq 0.68$$

$$P_o = 0.67 F_r + 0.41 F_a \quad \text{when} \quad \frac{F_a}{F_r} > 0.68$$

Equivalent load static

Single bearings and tandem arranged bearings:

$$P_o = F_r \quad \text{when} \quad \frac{F_a}{F_r} \leq 1.3$$

$$P_o = 0.5 F_r + 0.38 F_a \quad \text{when} \quad \frac{F_a}{F_r} > 1.3$$

For back to back and face to face arrangements:

$$P_o = F_r + 0.76 F_a$$

AXIAL CLEARANCE TABLES

Axial clearance of single row angular contact ball bearings arranged in "DB" and "DF"

Series 72...B		Series 73...B		Axial clearance value	
d mm		d mm		µm	
over	up to	over	up to	over	up to
10	30	15	25	16	36
30	50	25	40	17	47
50	80	40	70	25	65
80	150	70	100	25	76
-	-	100	190	35	95

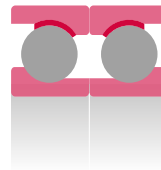

Angular Contact Ball Bearing

DATA TABLE - SINGLE ROW

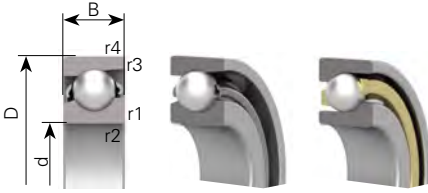

Part number	Principal dimensions			Load ratings			Speed limits		Weight	Dimensions		
	Bore	Outer	Width	Dynamic	Static	Fatigue	Grease	Oil		r1/r2	r3/r4	a
	d	D	B	Cr	Cor	Pu	rpm		Kg	mm		
mm			kN			1 min ⁻¹						
7200 B	10	30	9	4,95	2,5	0,11	19000	28000	0,031	0,6	0,3	13
7201 B	12	32	10	7,4	3,75	0,17	17000	24000	0,045	0,6	0,3	14
7202 B	15	35	11	7,45	3,9	0,18	16000	22000	0,048	0,6	0,3	16
7302 B	15	42	13	12,90	6,5	0,30	14000	19000	0,090	1,0	0,6	19
7203 B	17	40	12	9,9	5,5	0,25	14000	19000	0,065	0,6	0,3	18
7203 B TN	17	40	12	9,9	5,5	0,25	14000	19000	0,065	0,6	0,3	18
7303 B	17	47	14	14,8	8,1	0,37	12000	17000	0,120	1,0	0,6	21
7204 B	20	47	14	14,1	8,4	0,38	11000	16000	0,110	1,0	0,6	21
7304 B	20	52	15	17,3	9,7	0,44	10000	15000	0,150	1,1	0,6	23
7005 B	25	47	12	13,9	8,5	0,39	11000	16000	0,110	0,6	0,3	8
7005 B 2RSR	25	47	12	10,8	7,0	0,32	7750		0,120	0,6	0,3	8
7205 B	25	52	15	15,5	10,1	0,46	9500	14000	0,130	1,0	0,6	24
7305 B	25	62	17	24,4	14,6	0,66	8500	12000	0,250	1,1	0,6	27
7206 B	30	62	16	20,5	13,6	0,62	8500	12000	0,210	1,0	0,6	27
7306 B	30	72	19	29,3	19,0	0,86	7500	10000	0,370	1,1	0,6	31
7207 B	35	72	17	28,5	19,8	0,90	7500	10000	0,300	1,1	0,6	31
7307 B	35	80	21	36,7	24,3	1,10	7000	9500	0,510	1,5	1,0	35
7208 B	40	80	18	32,1	23,0	1,05	6700	9000	0,390	1,1	0,6	34
7308 B	40	90	23	44,8	30,3	1,38	6300	8500	0,670	1,5	1,0	39
7209 B	45	85	19	36,1	26,2	1,19	6300	8500	0,440	1,1	0,6	37
7309 B	45	100	25	58,3	40,1	1,82	5600	7500	0,900	1,5	1,0	43
7210 B	50	90	20	37,4	28,6	1,30	5600	7500	0,490	1,1	0,6	39
7310 B	50	110	27	69,3	47,9	2,18	5000	6700	1,150	2,0	1,0	47
7211 B	55	100	21	46,2	36,2	1,65	5300	7000	0,650	1,5	1,0	43
7311 B	55	120	29	78,8	56,4	2,56	4500	6000	1,450	2,0	1,0	51
7212 B	60	110	22	56,3	44,7	2,03	4800	6300	0,840	1,5	1,0	47
7312 B	60	130	31	90,0	65,5	2,98	4300	5600	1,850	2,1	1,1	56
7213 B	65	120	23	63,6	52,5	2,39	4300	5600	1,050	1,5	1,0	50
7313 B	65	140	33	101,0	75,3	3,38	4000	5300	2,250	2,1	1,1	60
7214 B	70	125	24	69,1	57,8	2,63	4300	5600	1,150	1,5	1,0	53
7314 B	70	150	35	114,0	86,0	3,73	3800	5000	2,750	2,1	1,1	64
7215 B	75	130	25	74,8	63,2	2,84	4000	5300	1,300	1,5	1,0	56
7315 B	75	160	37	125,0	97,5	4,09	3400	4500	3,300	2,1	1,1	68
7216 B	80	140	26	80,5	69,3	3,00	3800	5000	1,550	2,0	1,0	59
7316 B	80	170	39	135,0	109,0	4,43	3200	4300	3,900	2,1	1,1	72

Angular Contact Ball Bearing

DATA TABLE - SINGLE ROW

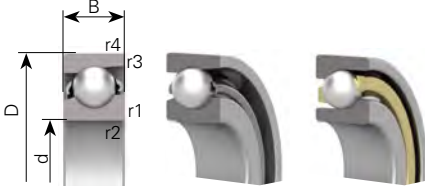

Part number	Principal dimensions			Load ratings			Speed limits		Weight	Dimensions		
	Bore	Outer	Width	Dynamic	Static	Fatigue	Grease	Oil		r1/r2	r3/r4	a
	d	D	B	Cr	Cor	Pu	rpm		Kg	mm		
mm			kN			1 min ⁻¹						
7217 B	85	150	28	93,1	81,1	3,40	3400	4500	1,950	2,0	1,0	64
7317 B	85	180	41	145,0	122,0	4,82	3000	4000	4,600	3,0	1,1	76
7218 B	90	160	30	107,0	93,8	3,81	3200	4300	2,400	2,0	1,0	67
7318 B	90	190	43	156,0	135,0	5,19	2800	3800	5,400	3,0	1,1	80
7219 B	95	170	32	116,0	101,0	3,99	3000	4000	2,900	2,1	1,1	71
7319 B	95	200	45	168,0	150,0	5,61	2600	3600	6,250	3,0	1,1	84
7220 B	100	180	34	129,0	116,0	4,46	2800	3800	3,450	2,1	1,1	76
7320 B	100	215	47	190,0	178,0	6,45	2400	3400	7,750	3,0	1,1	90
7222 B	110	200	38	153,0	145,0	5,29	2400	3400	4,800	2,1	1,1	84
7322 B	110	240	50	248,0	229,0	7,87	2000	3000	10,500	3,0	1,1	99
7328 B	140	300	62	290,0	334,0	10,24	1700	2400	21,600	4,0	1,5	123

TECHNICAL NOTEBOOK

ANGULAR CONTACT BALL BEARING DOUBLE ROW

ROLLWAY®



In this section:

	Page
Design Characteristics Applications Angular Misalignment	
ISO Specification Series	56
Nomenclature Equivalent Load Equations Shields Seal	57
Lubrication Radial Clearance Tables	58
Data Tables	59-60

REGAL®

Angular Contact Ball Bearing

DOUBLE ROW

DESIGN | CHARACTERISTICS | APPLICATIONS

Double row angular contact bearings

The inner and outer ring of these bearings each have a double raceway and the two rows of balls are so related that the contact angles are similar to that for a back-to-back arrangement. Thrust loads can be accommodated in either directions as well as fitting moments. The advantage of the double row bearing is that no clearance set-up operation is required during mounting operation.

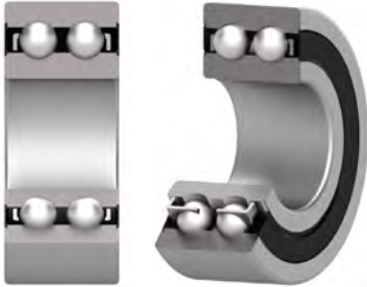

ANGULAR MISALIGNMENT

The following is an approximate guide to the misalignment that can be prevalent when fitting angular contact bearings:

0.0003 radians

Greater misalignment, particularly under pure axial load can become critical.

ISO SPECIFICATIONS

- Dimensions in accordance with ISO 15 (latest version)
- Precision class in accordance with ISO 492 (latest version)

SERIES

The standard series are 3200 | 3300



NOMENCLATURE

Suffixes:

2RS : 2 NBR seals with metallic insert

ZZ : 2 metallic shields

TN : Polyamide cage

P0 - P6 : Precision class

CN - C3 : Radial clearance class

EQUIVALENT LOAD EQUATIONS

For 3200 and 3300 series with one piece inner ring

Equivalent load P_e

$P_e = Fr + 0.73Fa$ when $Fa/Fr \leq 0.86$

$P_e = 0.62 Fr + 1.17Fa$ when $Fa/Fr > 0.86$

Equivalent static load P_o

$P_o = Fr + 0.63 Fa$

SHIELDS | SEALS

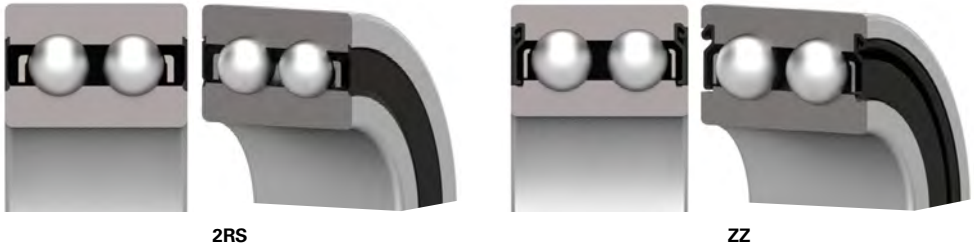

The non-contact metallic shields (ZZ) are pre-lubricated with the correct quantity of a lithium base grease which allows operating temperatures of $-30^{\circ}\text{C} + 120^{\circ}\text{C}$.

While the shields makes no contact with the inner ring, small dust particles or moisture can still enter inside the bearing. Shields are suitable for a dry environment with a low or medium dust contamination.

The speed limit are the same than the open version.

The contact seals (RS, 2RS) are made from NBR - Nitril Butadiene Rubber. The rubber withstands operating temperatures of 100°C max. They are reinforced with a metallic washer inside. The bearings are pre-lubricated with the correct quantity grease.

Sealed bearings have a lower maximum speed due to the contact between the seal lips and the inner ring. This contact will generate heat which will reduce the speed limit of -20% compared to an open or shielded bearing.

Angular Contact Ball Bearing

LUBRICATION

Standard shielded or sealed bearings are lubricated with lithium based grease, with a fill rate of 30%. The viscosity is 100 ISO VG

RADIAL CLEARANCE TABLES

Axial clearance of double row angular contact ball bearings



Bore diameter		Series 32 and 33				Series 33D			
d		C2		CN		C3		CN	
mm		µm		µm		µm		µm	
over	up to	min.	max.	min.	max.	min.	max.	min.	max.
-	10	1	11	5	21	12	28	-	-
10	18	1	12	6	23	13	31	-	-
18	24	2	14	7	25	16	34	-	-
24	30	2	15	8	27	18	37	16	35
30	40	2	16	9	29	21	40	18	38
40	50	2	18	11	33	23	44	22	44
50	65	3	22	13	36	26	48	25	48
65	80	3	24	15	49	30	54	29	54
80	100	3	26	18	46	35	63	35	63
100	110	4	30	22	53	48	73	42	73

Radial clearance ≈ 0,6 axial clearance

Angular Contact Ball Bearing

DATA TABLE - DOUBLE ROW

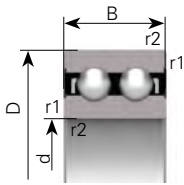

SEALS | 2RS

Part number	Principal dimensions			Load ratings			Speed limits		Weight	Dimensions	
	Bore	Outer	Width	Dynamic	Static	Fatigue	Grease	Oil		r1/r2	a
	d	D	B	Cr	Cor	Pu	rpm	1 min ⁻¹	Kg	mm	
3200	10	30	14,3	7,8	3,9	0,18	16000	22000	0,05	0,6	19
3201	12	32	15,9	10,6	5,1	0,23	15000	20000	0,06	0,6	22
3202	15	35	15,9	11,8	6,1	0,28	13000	18000	0,07	0,6	23
3302	15	42	19	16,3	8,7	0,40	10000	15000	0,13	1	27
3203 2RS	17	40	17,5	14,6	7,8	0,35	7500	-	0,1	0,6	27
3203	17	40	17,5	14,6	7,8	0,35	10000	15000	0,1	0,6	27
3303	17	47	22,2	20,8	10,6	0,48	9500	14000	0,19	1	31
3204	20	47	20,6	19,6	10,8	0,49	9000	13000	0,170	1,0	31
3304	20	52	22,2	23,2	12,9	0,59	8500	12000	0,230	1,1	34
3205	25	52	20,6	21,2	12,7	0,58	8000	11000	0,190	1,0	35
3305	25	62	25,4	29,2	17,3	0,79	7500	10000	0,370	1,1	40
3206	30	62	23,8	28,1	18,3	0,83	7000	9500	0,310	1,0	41
3306	30	72	30,2	38,0	24,5	1,11	6300	8500	0,580	1,1	47
3207	35	72	27,0	39,0	25,0	1,14	6000	8000	0,480	1,1	47
3307	35	80	34,9	51,0	30,0	1,36	5600	7500	0,780	1,5	54
3208	40	80	30,2	48,0	31,5	1,43	5600	7500	0,650	1,1	52
3308	40	90	36,5	62,0	39,0	1,77	5000	6700	1,050	1,5	58
3308 2RS	40	90	36,5	60,5	44,0	2,00	4200	-	1,070	1,5	58
3209	45	85	30,2	49,0	32,5	1,48	5000	6700	0,700	1,1	56
3309	45	100	39,7	71,0	57,0	2,59	4500	6000	1,410	1,5	64
3210	50	90	30,2	51,0	36,0	1,64	4800	6300	0,740	1,1	59
3310	50	110	44,4	85,0	75,0	3,41	4000	5300	1,900	2,0	73
3211	55	100	33,3	54,0	55,0	2,50	4300	5600	1,050	1,5	64
3311	55	120	49,2	98,0	88,0	4,00	3600	4800	2,480	2,0	80
3212	60	110	36,5	69,5	72,0	3,27	3800	5000	1,360	1,5	71
3312	60	130	54,0	114,0	112,0	5,09	3400	4500	3,170	2,1	86
3213	65	120	38,1	73,5	83,0	3,77	3600	4800	1,760	1,5	76
3313	65	140	58,7	129,0	130,0	5,84	3200	4300	4,010	2,1	94
3214	70	125	39,7	81,5	91,5	4,16	3200	4300	1,930	1,5	81
3314	70	150	63,5	143,0	146,0	6,33	2800	3800	5,040	2,1	101
3215	75	130	41,3	85,0	98,0	4,40	3200	4300	2,080	1,5	84
3315	75	160	68,3	163,0	166,0	6,96	2600	3600	6,160	2,1	107
3216	80	140	44,4	95,0	110,0	4,77	2800	3800	2,640	2,0	91
3316	80	170	68,3	176,0	186,0	7,56	2400	3400	6,930	2,1	112

Angular Contact Ball Bearing

DATA TABLE - DOUBLE ROW

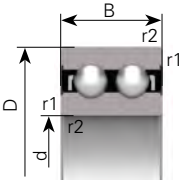

SEALS | 2RS

Part number	Principal dimensions			Load ratings			Speed limits		Weight	Dimensions	
	Bore	Outer	Width	Dynamic	Static	Fatigue	Grease	Oil		Kg	r1/r2
	d	D	B	Cr	Cor	Pu	rpm		mm		
	mm			kN			1 min ⁻¹				
3217	85	150	49,2	112,0	132,0	5,54	2600	3600	3,390	2,0	97
3317	85	180	73,0	190,0	200,0	7,90	2200	3200	8,300	3,0	119
3218	90	160	52,4	125,0	146,0	5,94	2400	3400	4,140	2,0	104
3318	90	190	73,0	216,0	240,0	9,22	2000	3000	9,230	3,0	125
3219	95	170	55,6	140,0	163,0	6,44	2200	3200	5,000	2,1	111
3319	95	200	77,8	220,0	245,0	9,17	1900	2800	11,400	3,0	133
3220	100	180	60,3	160,0	196,0	7,53	2000	3000	6,100	2,1	118
3320	100	215	82,6	240,0	280,0	10,14	1800	2600	14,200	3,0	139
3222	110	200	69,8	190,0	228,0	8,32	1900	2800	8,790	2,1	132
3322	110	240	92,1	280,0	400,0	13,74	1800	2600	19,000	3,0	153

TECHNICAL NOTEBOOK

CYLINDRICAL ROLLER BEARING SINGLE ROW

ROLLWAY®

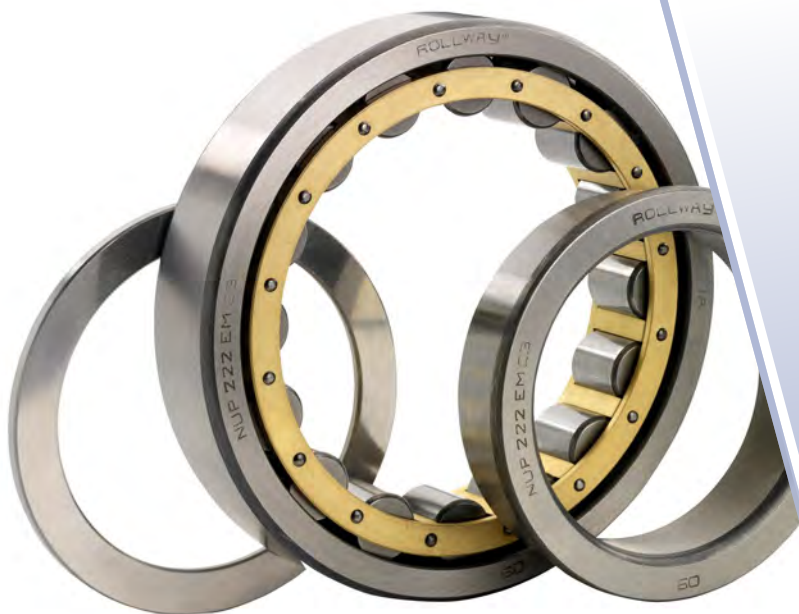

In this section:

	Page
Design Characteristics Applications Angular Misalignment	
ISO Specification	62
Seriee Nomenclature	63
Equivalent Load Equations Lubrication	63-65
Radial Clearance Tables.....	66
Data Tables	67-96

REGAL®

Cylindrical Roller Bearing

SINGLE ROW

DESIGN | CHARACTERISTICS | APPLICATIONS

Cylindrical roller bearings are manufactured in a number of designs as indicated on the following pages, the predominant type being the single row cylindrical roller bearing. The rollers are essentially cylindrical in shape providing modified line contact with the cylindrical inner and outer ring raceways. The roller and cage assembly are guided axially by the integral flanges (ribs) on one of the bearing rings. This design facilitates ease of mounting and dismounting, particularly where both races are an interference fit on their seatings. Roller bearings with flanges (ribs) on one race only do not provide any end location. Various roller bearings with ribs on both races provide axial location, and are capable of carrying light or intermittent axial loading. These patterns are of the NJ, NUP and NJ+HJ types. If used for axial location and light axial loads the contact between the flanges (ribs) and the roller ends is that of a sliding bearing, not rolling bearing, therefore lubrication is of paramount importance.

The cylindrical shape of the rollers allows the inner ring to have considerable axial movement relative to the outer ring (except the NH type). This feature is valuable in accommodating thermal expansion in applications where both the inner ring and outer ring must be press-fitted. Also, since the inner and outer rings are separable from each other, the assembly of equipment is frequently facilitated.

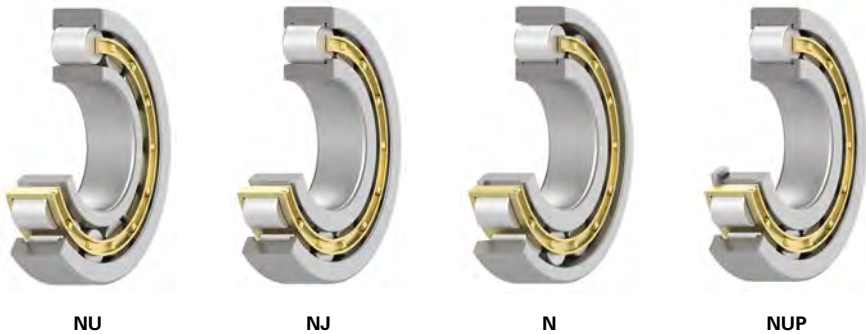

ANGULAR MISALIGNMENT

The following is an approximate guide to the misalignment that can be accommodated in a cylindrical roller bearing:

0.0003 radians

Greater misalignment under heavy radial load can be critical.

ISO SPECIFICATIONS

- Dimensions in accordance with ISO 15 (latest version)
- Precision class in accordance with ISO 492 (latest version)
- Radial clearance in accordance with ISO 5753 (latest version)

SERIES

Only the underlined series are popular. All series are available in the for designs.



NU 200 EM

NU 300 EM

NU 1000 EM

NU 2200 EM

NU 2300 EM

NOMENCLATURE

Prefixes:

R : Bearing without outer ring

P0 - P6 : Precision class

Suffixes:

E : Higher load rating

M : Brass cage guided on the rollers

MA : Brass cage guided on the outer ring

NA : Non-interchangeable rings

C2 - C4 : Radial clearance class

P0 - P6 : Precision class

EQUIVALENT LOAD EQUATIONS

Equivalent dynamic load P_e

The equivalent dynamic radial load of a cylindrical roller bearing subjected to a pure radial load is:

$$P = F_r \text{ [KN]}$$

Equivalent static load P_o

The equivalent static load of a cylindrical roller bearing subjected to a pure radial load is:

$$P_o = F_r \text{ [KN]}$$

Cylindrical Roller Bearing

SINGLE ROW

Axial Loading Capacity

The axial dynamic capacity of a roller bearing having ribs on the outer or inner races, types NJ, NUP and HJ, is:

$$F_{az} = \frac{K_1 C_{or} 10^4}{n (d+D)} - K_2 F_r$$

where:

F_{az} = maximum allowable axial load [N]

C_{or} = static radial load [N]

F_r = radial component of loading [N]

n = speed [RPM]

d = inner diameter [mm]

D = outer diameter [mm]

K_1 = auxiliary factor, see table

K_2 = auxiliary factor, see table

Factor K1 and K2

Lubrication		
Factor	oil	grease
K_1	1	0.6
K_2	0.005	0.003

The permissible axial load depends on the ability of the roller ends to slide on the surface of the ribs (not fatigue values). It is therefore very important that adequate lubrication is present to assist this and dissipate heat generated by this action. The formula mentioned above is used as a guidance to calculate a suitable axial load along with the “k” factor mentioned in table 2.

The formula is based on ideal conditions with:

- maximum temperature differential of 60°C between ambient and bearing temperature
- a specific heat elimination of 0.5 mW/mm² C
- viscosity ratio $k_v = 1.5$. (k_v factor)

The k_v factor “k” indicates an effective viscosity ratio v at working temperatures, against v_1 viscosity required for a satisfactory lubrication of the bearing.

In case of grease lubrication for v ratio the basic oil viscosity will be used. If viscosity ratio "K" is smaller than 1.5, friction and wear is generated. These can be reduced at lower speeds by use of oils with EP additives.

The thrust loads F_{az} obtained by the formulae are valid for constant axial loadings. For short duration the values can be doubled and may be trebled for shock loads.

For cylindrical roller bearings to function satisfactory under thrust loads there must also be radial loads present change sentence to " radial loads must be present. The ratio of F_a/F_r should not exceed 0.4.

The axial loading of bearings has, of course, a certain influence upon their service life.

This influence can be practically ignored if the F_a/F_r ratio is ≤ 0.2 in case of bearings in series 10, 2, 3, and 4 and $F_a/F_r \leq 0.4$ for bearings in series 22 and 23.

In any case of thrust loads which act upon bearings factor F_a (N) should not exceed the numerical value of $1.5 D^2$ (D = outer diameter of the bearing in mm).

In case of certain high thrust loads ($F_a \geq D^2$) it is recommended to have the ribs of inner and outer rings completely supported by the integral parts of the shaft & housing.

NUP, NJ and HJ type bearings which take thrust loads from both directions should always be so arranged that – if the construction of the bearing permits it – main thrust loads are taken by the ribs.

LUBRICATION

Refer to the lubrication chapter (pages 340-344) to have more info about the lubrication of cylindrical roller bearings.

Cylindrical Roller Bearing

SINGLE ROW

RADIAL CLEARANCE TABLES

For cylindrical bore with Interchangeable rings



Bore diameter		Clearance class									
d		C2		CN		C3		C4		C5	
mm		µm		µm		µm		µm		µm	
over	up to	min.	max.	min.	max.	min.	max.	min.	max.	min.	max.
	24	0	25	20	45	35	60	50	75	65	90
24	30	0	25	20	45	35	60	50	75	70	95
30	40	5	30	25	50	45	70	60	85	80	105
40	50	5	35	30	60	50	80	70	100	95	125
50	65	10	40	40	70	60	90	80	110	110	140
65	80	10	45	40	75	65	100	90	125	130	185
80	100	15	50	50	85	75	110	105	140	155	190
100	120	15	55	50	90	85	125	125	165	180	220
120	140	15	60	60	105	100	145	145	190	200	245
140	160	20	70	70	120	115	165	165	215	225	275
160	180	25	75	75	125	120	170	170	220	250	300
180	200	35	90	90	145	140	195	195	250	275	330
200	225	45	105	105	165	160	220	220	280	305	365
225	250	45	110	110	175	170	235	235	300	330	385
250	280	55	125	125	195	190	260	260	330	370	440
280	315	55	130	130	205	200	275	275	350	410	485
315	365	85	145	145	225	225	305	305	385	455	535
355	400	100	190	190	280	280	370	370	460	510	600
400	450	110	210	210	310	310	410	410	510	565	665
450	500	110	220	220	330	330	440	440	550	625	735
500	560	120	240	240	360	360	480	480	600	660	780
560	630	140	260	260	380	380	500	500	620	675	795
630	710	145	285	285	425	425	565	565	705	705	845
710	800	150	310	310	470	470	630	630	790	790	950
800	900	180	350	350	520	520	690	690	860	860	1030
900	1000	200	390	390	580	580	770	770	960	960	1150
1000	1120	220	430	430	640	640	850	850	1060	1060	1270
1120	1250	230	470	470	710	710	950	950	1190	1190	1430
1250	1440	270	530	530	790	790	1050	1050	1310	1310	1570
1400	1600	330	610	610	890	890	1170	1170	1450	1450	1730

For tapered bore

Radial clearance for bearings with tapered bore is selected in the above table from one group to the right, for example radial clearance CN for cylindrical bore bearings match C3 for tapered bore bearings.

Note

For the radial clearance for non-interchangeable rings refer to the chapter double row cylindrical roller bearing (page 100).

Cylindrical Roller Bearing

DATA TABLE - SINGLE ROW



Part number	Principal dimensions			Basic load ratings			Speed limits		Weight	Radius		Dimensions	
	Bore	Outer	Height	Dynamic	Static	Fatigue	Grease	Oil		rs min	r1s min	F	E
	d	D	B	Cr	Cor	Pu	rpm	1 min ⁻¹	Kg	mm	mm	mm	
NU 202 E	15	35	11	13,5	11,2	1,37	18000	22000	0,05	0,6	0,3	19,3	
NJ 203	17	40	12	11,2	9	1,10	17000	20000	0,09	0,6	0,3	22,1	
NU 203 M	17	40	12	14,5	12,8	1,56	18000	20000	0,08	0,6	0,3	22,1	
NU 203 EM	17	40	12	17,6	14,6	1,78	18000	18000	0,07	0,6	0,3	22,1	
NU 2203 E	17	40	16	22,4	19,8	2,41	16000	19000	0,01	0,6	0,3	22,1	
NJ 2203 E	17	40	16	22,1	19,8	2,41	16000	19000	0,01	0,6	0,3	22,1	
NUP 2203 E	17	40	16	22,4	19,8	2,41	16000	19000	0,09	0,6	0,3	22,1	
NU 303	17	47	14	16,4	13	1,59	13000	16000	0,12	1	0,6	25,1	
N 204	20	47	14	15,2	12,5	1,52	15000	18000	0,11	1	0,6		40
NJ 204 E	20	47	14	25,7	22,6	2,76	15000	18000	0,11	1	0,6	26,5	
NJ 204 EM	20	47	14	25,7	22,6	2,76	15000	18000	0,11	1	0,6	26,5	
NU 204 E	20	47	14	25,7	22,6	2,76	15000	18000	0,11	1	0,6	26,5	
NU 204 EM	20	47	14	25,7	22,6	2,76	17000	20000	0,12	1	0,6	26,5	
NUP 204 EM	20	47	14	25,7	22,6	2,76	15000	18000	0,11	1	0,6	26,5	
NUP 204 E	20	47	14	25,7	22,6	2,76	15000	18000	0,11	1	0,6	26,5	
NJ 2204 E	20	47	18	30,6	28,3	3,45	13000	16000	0,14	1	0,6	26,5	
NJ 2204 EM	20	47	18	30,6	28,3	3,45	13000	16000	0,14	1	0,6	26,5	
NU 2204 E	20	47	18	30,6	28,3	3,45	13000	16000	0,14	1	0,6	27	
NU 2204 EM	20	47	18	30,5	28,2	3,44	13000	16000	0,13	1	0,6	26,5	
NUP 2204 E	20	47	18	30,6	28,3	3,45	13000	16000	0,14	1	0,6	28,5	
NJ 304 EM	20	52	15	31,7	26,9	3,28	12000	15000	0,14	1,1	0,6	28,5	
NU 304 EM	20	52	15	31,7	26,9	3,28	12000	15000	0,14	1,1	0,6	28,5	
NUP 304 EM	20	52	15	31,7	26,9	3,28	12000	15000	0,16	1,1	0,6	27,5	
NJ 2304 EM	20	52	21	42	38,8	4,73	11000	14000	0,20	1,1	0,6	27,5	
NJ 2304 E	20	52	21	42	38,8	4,73	11000	14000	0,20	1,1	0,6	27,5	
NU 2304 EM	20	52	21	42	38,8	4,73	11000	14000	0,22	1,1	0,6	27,5	
NU 2304 E	20	52	21	42	38,8	4,73	11000	14000	0,20	1,1	0,6	27,5	
NUP 2304 EM	20	52	21	42	38,8	4,73	11000	14000	0,24	1,1	0,6	30,5	
NU 1005	25	47	12	13,4	20,5	2,50	15000	18000	0,08	0,6	0,3	32	
N 205	25	52	15	17,7	15,7	1,91	12000	15000	0,16	1	0,6		46,5
NJ 205 E	25	52	15	28,5	26,7	3,26	12000	15000	0,14	1	0,6	31,5	
NJ 205 EM	25	52	15	28,5	26,7	3,26	12000	15000	0,14	1	0,6	31,5	
NU 205 E	25	52	15	28,5	26,7	3,26	12000	15000	0,14	1	0,6	31,5	
NU 205 EM	25	52	15	28,5	26,7	3,26	12000	15000	0,14	1	0,6	31,5	
NUP 205 E	25	52	15	28,5	26,7	3,26	12000	15000	0,14	1	0,6	31,5	
NJ 2205 E	25	52	18	34,6	34,3	4,18	11000	14000	0,16	1	0,6	31,5	

Cylindrical Roller Bearing

DATA TABLE - SINGLE ROW



Part number	Principal dimensions			Basic load ratings			Speed limits		Weight	Radius		Dimensions	
	Bore	Outer	Height	Dynamic	Static	Fatigue	Grease	Oil		rs min	r1s min	F	E
	d	D	B	Cr	Cor	Pu	rpm		Kg	mm		mm	
mm			kN			1 min ⁻¹							
NJ 2205 EM	25	52	18	34,6	34,3	4,18	11000	14000	0,17	1	0,6	31,5	
NU 2205 E	25	52	18	34,6	34,3	4,18	11000	14000	0,17	1	0,6	31,5	
NU 2205 EM	25	52	18	34,6	34,3	4,18	11000	14000	0,17	1	0,6	31,5	
NUP 2205 E	25	52	18	34,6	34,3	4,18	11000	14000	0,16	1	0,6	31,5	
NUP 2205 EM	25	52	18	34,6	34,3	4,18	11000	14000	0,17	1	0,6	31,5	
N 305 EM	25	62	17	41,2	37	4,51	10000	13000	0,24	1,1	1,1		54
NJ 305 E	25	62	17	41,2	37	4,51	10000	13000	0,24	1,1	1,1	34	
NJ 305 M	25	62	17	37,3	37,4	4,56	9000	12000	0,24	1,1	1,1	35	
NJ 305 EM	25	62	17	42,5	37	4,51	10000	13000	0,24	1,1	1,1	34	
NU 305 E	25	62	17	29,3	25,2	3,07	10000	13000	0,24	1,1	1,1	34	
NU 305 EM	25	62	17	42,5	37,4	4,56	10000	13000	0,24	1,1	1,1	34	
NU 305 M	25	62	17	29,3	25,2	3,07	10000	13000	0,24	1,1	1,1	35	
NUP 305 M	25	62	17	31,7	31,2	3,80	10000	13000	0,30	1,1	1,1	34	
NUP 305 EM	25	62	17	41,2	37	4,51	10000	13000	0,30	1,1	1,1	34	
NJ 2305 E	25	62	24	56,7	55,7	6,79	9500	12000	0,35	1,1	1,1	34	
NJ 2305 EM	25	62	24	56,7	55,7	6,79	9500	12000	0,35	1,1	1,1	34	
NU 2305 EM	25	62	24	56,7	55,7	6,79	8500	12000	0,35	1,1	1,1	34	
NU 2305 E	25	62	24	56,7	55,7	6,79	9500	12000	0,34	1,1	1,1	34	
NUP 2305 E	25	62	24	56,7	55,7	6,79	9500	12000	0,35	1,1	1,1	34	
NU 405 M	25	80	24	50,6	44,4	5,41	8500	10000	0,61	1,5	1,5	38,8	
NUP 405 M	25	80	24	50,6	44,4	5,41	8500	10000	0,65	1,5	1,5	38,8	
N 206 EM	30	62	16	39,7	37,9	4,62	10000	13000	0,24	1	0,6		55,5
NJ 206 E	30	62	16	40	37,9	4,62	10000	13000	0,20	1	0,6	37,5	
NJ 206 EM	30	62	16	40	37,9	4,62	10000	13000	0,20	1	0,6	37,5	
NU 206 E	30	62	16	39,7	37,9	4,62	10000	13000	0,21	1	0,6	37,5	
NU 206 EM	30	62	16	39,7	37,9	4,62	10000	13000	0,21	1	0,6	37,5	
NUP 206 EM	30	62	16	39,7	37,9	4,62	10000	13000	0,20	1	0,6	37,5	
NUP 206 E	30	62	16	39,7	37,9	4,62	10000	13000	0,20	1	0,6	37,5	
NUP 206 M	30	62	16	23,4	21,5	2,62	10000	13000	0,20	1	0,6	38,5	
NJ 2206 EM	30	62	20	48,9	49,9	6,09	9000	11000	0,25	1	0,6	37,5	
NJ 2206 E	30	62	20	48,9	49,9	6,09	9000	11000	0,25	1	0,6	37,5	
NU 2206 M	30	62	20	48	53,9	6,57	7500	11000	0,30	1	0,6	37,5	
NU 2206 EM	30	62	20	48,9	49,9	6,09	9000	11000	0,26	1	0,6	37,5	
NU 2206 E	30	62	20	48,9	49,9	6,09	9000	11000	0,25	1	0,6	37,5	
NUP 2206 E	30	62	20	48,9	49,9	6,09	9000	11000	0,25	1	0,6	37,5	
NJ 306 E	30	72	19	50,5	47	5,73	8500	10000	0,35	1,1	1,1	40,5	

Cylindrical Roller Bearing

DATA TABLE - SINGLE ROW



Part number	Principal dimensions			Basic load ratings			Speed limits		Weight	Radius		Dimensions	
	Bore	Outer	Height	Dynamic	Static	Fatigue	Grease	Oil		rs min	r1s min	F	E
	d	D	B	Cr	Cor	Pu	rpm		Kg	mm	mm	mm	
	mm			kN			1 min ⁻¹			mm		mm	
NJ 306 EM	30	72	19	58,3	52,8	6,44	8500	10000	0,37	1,1	1,1	40,5	
NU 306 E	30	72	19	50,5	47	5,73	8500	10000	0,37	1,1	1,1	40,5	
NU 306 EM	30	72	19	58,3	52,8	6,44	8500	10000	0,37	1,1	1,1	40,5	
NU 306 M	30	72	19	38,7	35,2	4,29	8500	10000	0,37	1,1	1,1	42	
NUP 306 E	30	72	19	50,5	47	5,73	8500	10000	0,38	1,1	1,1	40,5	
N 2306	30	72	27	51,4	50,8	6,20	8500	10000	0,53	1,1	1,1		62
NJ 2306 EM	30	72	27	71,9	74	9,02	8500	10000	0,52	1,1	1,1	40,5	
NJ 2306 E	30	72	27	71,9	74	9,02	8500	10000	0,52	1,1	1,1	40,5	
NU 2306 E	30	72	27	71,9	74	9,02	8500	10000	0,50	1,1	1,1	40,5	
NUP 2306 E	30	72	27	71,9	74	9,02	8500	10000	0,53	1,1	1,1	40,5	
NUP 2306 EM	30	72	27	71,9	74	9,02	8500	10000	0,53	1,1	1,1	40,5	
NUP 2306 M	30	72	27	51,4	50,8	6,20	8500	10000	0,53	1,1	1,1	42	
NJ 406 M	30	90	23	65	57,8	7,05	7500	9000	0,87	1,5	1,5	45	
NU 406 M	30	90	23	65	57,8	7,05	7500	9000	0,87	1,5	1,5	45	
NU 1007	35	62	14	21,6	21,8	2,66	10000	13000	0,18	1	0,5	42	
N 207	35	72	17	33,6	31,5	3,84	9000	11000	0,30	1,1	0,6		61,8
NJ 207 E	35	72	17	49,9	49,7	6,06	9000	11000	0,30	1,1	0,6	44	
NJ 207 EM	35	72	17	49,9	49,7	6,06	9000	11000	0,30	1,1	0,6	44	
NJ 207 M	35	72	17	33,6	31,5	3,84	9000	11000	0,30	1,1	0,6	43,8	
NU 207 E	35	72	17	49,9	49,7	6,06	9000	11000	0,30	1,1	0,6	44	
NU 207 EM	35	72	17	49,9	49,7	6,06	9000	11000	0,30	1,1	0,6	44	
NUP 207 E	35	72	17	49,9	49,7	6,06	9000	11000	0,30	1,1	0,6	44	
NJ 2207 E	35	72	23	64,9	69,8	8,51	8000	9500	0,39	1,1	0,6	44	
NJ 2207 EM	35	72	23	64,9	69,8	8,51	8000	9500	0,39	1,1	0,6	44	
NJ 2207 M	35	72	23	49	51,3	6,26	8000	9500	0,39	1,1	0,6	43,8	
NU 2207 E	35	72	23	64,9	69,8	8,51	8000	9500	0,39	1,1	0,6	44	
NU 2207 EM	35	72	23	64,9	69,8	8,51	8000	9500	0,39	1,1	0,6	44	
NUP 2207 E	35	72	23	65,3	70,3	8,57	8000	9500	0,43	1,1	0,6	44	
N 307 E	35	80	21	63,8	61,6	7,51	8500	10000	0,47	1,5	1,1		70,2
N 307 EM	35	80	21	63,8	61,6	7,51	8500	10000	0,47	1,5	1,1		70,2
NJ 307 E	35	80	21	63,8	61,6	7,51	8500	10000	0,49	1,5	1,1	46,2	
NJ 307 EM	35	80	21	70,2	65,2	7,95	8500	10000	0,48	1,5	1,1	46,2	
NJ 307 M	35	80	21	47,3	44,1	5,38	8500	10000	0,48	1,5	1,1	46,2	
NU 307 E	35	80	21	63,8	61,6	7,51	8500	10000	0,48	1,5	1,1	46,2	
NU 307 EM	35	80	21	70,2	65,2	7,95	8500	10000	0,48	1,5	1,1	46,2	
NU 307 M	35	80	21	47,3	44,1	5,38	8500	10000	0,48	1,5	1,1	46,2	

Cylindrical Roller Bearing

DATA TABLE - SINGLE ROW



Part number	Principal dimensions			Basic load ratings			Speed limits		Weight	Radius		Dimensions	
	Bore	Outer	Height	Dynamic	Static	Fatigue	Grease	Oil		rs min	r1s min	F	E
	d	D	B	Cr	Cor	Pu	rpm		Kg	mm		mm	
	mm			kN			1 min ⁻¹						
NUP 307 E	35	80	21	63,8	61,6	7,51	8500	10000	0,48	1,5	1,1	46,2	
NUP 307 EM	35	80	21	63,8	61,6	7,51	8500	10000	0,48	1,5	1,1	46,2	
NJ 2307 E	35	80	31	85,5	89,9	11,0	7500	9000	0,72	1,5	1,1	46,2	
NJ 2307 M	35	80	31	58,3	57,6	7,02	7500	9000	0,72	1,5	1,1	46,2	
NU 2307 E	35	80	31	85,5	89,9	11,0	7500	9000	0,70	1,5	1,1	46,2	
NU 2307 M	35	80	31	58,3	57,6	7,02	7500	9000	0,72	1,5	1,1	46,2	
NUP 2307 E	35	80	31	85,5	89,9	11,0	7500	9000	0,70	1,5	1,1	46,2	
NU 407 M	35	100	25	75,7	69,4	8,46	6700	8000	1	1,5	1,5	53	
NU 407 M	35	100	25	75,7	69,4	8,46	6700	8000	1	1,5	1,5	53	
NU 1008 M	40	68	15	24	25,7	3,13	9500	12000	0,22	1	0,6	47	
N 208 EM	40	80	18	51,5	53	6,46	7000	9000	0,44	1,1	1,1		70
NJ 208 E	40	80	18	52,6	51,6	6,29	8000	9500	0,38	1,1	1,1	49,5	
NJ 208 EM	40	80	18	52,6	51,6	6,29	8000	9500	0,38	1,1	1,1	49,5	
NJ 208 M	40	80	18	43,7	42,9	5,23	8000	9500	0,38	1,1	1,1	50	
NU 208 EM	40	80	18	52,6	51,6	6,29	8000	9500	0,38	1,1	1,1	49,5	
NU 208 E	40	80	18	52,6	51,6	6,29	8000	9500	0,37	1,1	1,1	49,5	
NU 208 M	40	80	18	43,7	42,9	5,23	8000	9500	0,38	1,1	1,1	50	
NUP 208 E	40	80	18	52,6	51,6	6,29	8000	9500	0,38	1,1	1,1	49,5	
NUP 208 EM	40	80	18	52,6	51,6	6,29	8000	9500	0,38	1,1	1,1	49,5	
NJ 2208 E	40	80	23	70,3	74,8	9,12	7500	9000	0,50	1,1	1,1	49,5	
NJ 2208 EM	40	80	23	70,3	74,8	9,12	7500	9000	0,50	1,1	1,1	49,5	
NU 2208 EMA	40	80	23	70,3	74,8	9,12	7500	9000	0,56	1,1	1,1	49,5	
NUP 2208 E	40	80	23	70,3	74,8	9,12	7500	9000	0,49	1,1	1,1	49,5	
NUP 2208 EM	40	80	23	76,3	77,5	9,45	7500	9000	0,49	1,1	1,1	49,5	
N 308	40	90	23	56,2	53,8	6,56	7000	8500	0,66	1,5	1,5		77,5
NJ 308 E	40	90	23	79,9	77,5	9,45	7000	8500	0,68	1,5	1,5	52	
NJ 308 EM	40	90	23	90,4	84,7	10,3	7000	8500	0,68	1,5	1,5	52	
NJ 308 M	40	90	23	56,2	53,8	6,56	7000	8500	0,66	1,5	1,5	53,5	
NU 308 E	40	90	23	79,9	77,5	9,45	7000	8500	0,65	1,5	1,5	52	
NU 308 EM	40	90	23	90,4	84,7	10,3	7000	8500	0,65	1,5	1,5	52	
NU 308 M	40	90	23	56,2	53,8	6,56	7000	8500	0,66	1,5	1,5	53,5	
NU 308 E	40	90	23	81,5	87,3	10,6	7000	8500	0,83	1,5	1,5	52	
NUP 308 EM	40	90	23	81,5	87,3	10,6	7000	8500	0,83	1,5	1,5	52	
NJ 2308 E	40	90	33	111	118	14,4	6700	8000	0,95	1,5	1,5	52	
NJ 2308 EM	40	90	33	111	118	14,4	6700	8000	0,95	1,5	1,5	52	
NU 2308 E	40	90	33	111	118	14,4	6700	8000	0,95	1,5	1,5	52	

Cylindrical Roller Bearing

DATA TABLE - SINGLE ROW



Part number	Principal dimensions			Basic load ratings			Speed limits		Weight	Radius		Dimensions	
	Bore	Outer	Height	Dynamic	Static	Fatigue	Grease	Oil		rs min	r1s min	F	E
	d	D	B	Cr	Cor	Pu	rpm		Kg	mm		mm	
	mm			kN			1 min ⁻¹						
NU 2308 EM	40	90	33	113	121	14,8	6700	8000	0,95	1,5	1,5	52	
NU 2308 M	40	90	33	80	84,9	10,4	6700	8000	0,95	1,5	1,5	53,5	
NUP 2308 E	40	90	33	111	118	14,4	6700	8000	0,95	1,5	1,5	52	
NUP 2308 EM	40	90	33	111	118	14,4	6700	8000	0,95	1,5	1,5	52	
N 408 M	40	110	27	93,8	86,8	10,6	6000	7000	1,31	2	2		92,0
NJ 408 M	40	110	27	93,8	86,8	10,6	6000	7000	1,31	2	2	58	
NU 408 M	40	110	27	93,8	86,8	10,6	6000	7000	1,31	2	2	58	
NUP 408 M	40	110	27	93,8	86,8	10,6	6000	7000	1,31	2	2	58	
NU 1009 M	45	75	16	31,4	34,8	4,24	9000	11000	0,29	1	0,6	52,5	
N 209 M	45	85	19	46	46,9	5,72	7500	9000	0,44	1,1	1,1		75
NJ 209 EM	45	85	19	66,6	71,2	8,68	8000	6300	0,52	1,1	1,1	54,5	
NJ 209 E	45	85	19	60,2	62,8	7,66	7500	9000	0,44	1,1	1,1	54,5	
NU 209 E	45	85	19	60,2	62,8	7,66	7500	9000	0,43	1,1	1,1	54,5	
NUP 209 E	45	85	19	60,2	62,8	7,66	7500	9000	0,44	1,1	1,1	54,5	
NUP 209 EM	45	85	19	63	66,4	8,10	8000	6300	0,52	1,1	1,1	54,5	
NJ 2209 E	45	85	23	76,1	84,6	10,3	5500	8000	0,55	1,1	1,1	54,5	
NJ 2209 EM	45	85	23	76,1	84,6	10,3	5500	8000	0,55	1,1	1,1	54,5	
NJ 2209 M	45	85	23	61,2	67,8	8,27	7500	9000	0,53	1,1	1,1	55	
NU 2209 E	45	85	23	76,1	84,6	10,3	5500	8000	0,55	1,1	1,1	54,5	
NU 2209 EM	45	85	23	76,1	84,6	10,3	5500	8000	0,55	1,1	1,1	54,5	
NU 2209 M	45	85	23	61,2	67,8	8,27	7500	9000	0,53	1,1	1,1	55	
NUP 2209 E	45	85	23	73,9	81,6	9,95	7500	9000	0,53	1,1	1,1	54,5	
N 309 EM	45	100	25	96,9	97,7	11,9	6000	7000	0,89	1,5	1,5		86,5
NJ 309 E	45	100	25	96,9	97,7	11,9	6000	7000	0,89	1,5	1,5	58,5	
NJ 309 EM	45	100	25	105,9	102,1	12,5	6000	7000	0,89	1,5	1,5	58,5	
NJ 309 M	45	100	25	71,2	67,8	8,27	6000	7000	0,89	1,5	1,5	58,5	
NU 309 E	45	100	25	96,9	97,7	11,9	6000	7000	0,87	1,5	1,5	58,5	
NU 309 EM	45	100	25	105,9	102,1	12,5	6000	7000	0,89	1,5	1,5	58,5	
NU 309 M	45	100	25	71,2	67,8	8,27	6000	7000	0,89	1,5	1,5	58,5	
NUP 309 E	45	100	25	96,9	97,7	11,9	6000	7000	0,89	1,5	1,5	58,5	
NUP 309 EM	45	100	25	105,9	102,1	12,5	6000	7000	0,89	1,5	1,5	58,5	
NUP 2309 EM	45	100	36	129,4	141,2	17,2	6000	7000	1,29	1,5	1,5	58,5	
NJ 2309 M	45	100	36	103	110	13,4	6000	7000	1,29	1,5	1,5	58,5	
NU 2309 M	45	100	36	103	110	13,4	6000	7000	1,29	1,5	1,5	58,5	
NU 2309 EM	45	100	36	129,4	141,2	17,2	6000	7000	1,29	1,5	1,5	58,5	
NUP 2309 E	45	100	36	130	142	17,3	6000	7000	1,25	1,5	1,5	58,5	

Cylindrical Roller Bearing

DATA TABLE - SINGLE ROW



Part number	Principal dimensions			Basic load ratings			Speed limits		Weight	Radius		Dimensions	
	Bore	Outer	Height	Dynamic	Static	Fatigue	Grease	Oil		rs min	r1s min	F	E
	d	D	B	Cr	Cor	Pu	rpm		Kg	mm		mm	
	mm			kN			1 min ⁻¹						
NUP 2309 EM	45	100	36	129,4	141,2	17,2	6000	7000	1,29	1,5	1,5	58,5	
NUP 2309 M	45	100	36	103	110	13,4	6000	7000	1,29	1,5	1,5	58,5	
N 409 M	45	120	29	104	97,8	11,9	5600	6700	1,66	2	2		100,5
NJ 409 M	45	120	29	121,2	111,5	13,6	5600	6700	1,87	1,5	1,5	64,5	
NU 409 M	45	120	29	104	97,8	11,9	5600	6700	1,66	2	2	64,5	
NUP 409 M	45	120	29	104	97,8	11,9	5600	6700	1,66	2	2	64,5	
NJ 1010 M	50	80	16	32,1	36,1	4,40	8500	10000	0,32	1	0,6	57,5	
NU 1010 M	50	80	16	32,1	36,1	4,40	8500	10000	0,31	1	0,6	57,5	
NJ 210 EM	50	90	20	68,8	75,7	9,23	6000	7500	0,59	1,1	1,1	60,4	
NJ 210 E	50	90	20	63,7	68,3	8,33	6700	8000	0,50	1,1	1,1	59,5	
NJ 210 M	50	90	20	48,2	51	6,22	6700	8000	0,49	1,1	1,1	60,4	
NU 210 EM	50	90	20	68,8	75,7	9,23	6700	8000	0,48	1,1	1,1	59,5	
NU 210 E	50	90	20	63,7	68,3	8,33	6700	8000	0,49	1,1	1,1	59,5	
NU 210 E	50	90	20	63,7	68,3	8,33	6700	8000	0,52	1,1	1,1	59,5	
NJ 2210 E	50	90	23	76,8	87,6	10,7	6900	8300	0,60	1,1	1,1	59,5	
NJ 2210 EM	50	90	23	76,8	87,6	10,7	6900	8300	0,60	1,1	1,1	59,5	
NJ 2210 M	50	90	23	61,8	70,2	8,56	6900	8300	0,57	1,1	1,1	60,4	
NU 2210 EM	50	90	23	76,8	87,6	10,7	6900	8300	0,58	1,1	1,1	59,5	
NU 2210 E	50	90	23	76,8	87,6	10,7	6900	8300	0,58	1,1	1,1	59,5	
NU 2210 E	50	90	23	61,8	70,2	8,56	6900	8300	0,57	1,1	1,1	60,4	
NUP 2210 E	50	90	23	76,8	87,6	10,7	6900	8300	0,60	1,1	1,1	59,5	
NUP 2210 EM	50	90	23	76,8	87,6	10,7	6900	8300	0,60	1,1	1,1	59,5	
NJ 310 E	50	110	27	110	112	13,7	6000	7000	1,14	2	2	65	
NJ 310 EM	50	110	27	119	125	15,2	5300	6700	1,34	2	2	65	
NJ 310 M	50	110	27	86,9	86,2	10,5	6000	7000	1,14	2	2	65	
NU 310 E	50	110	27	110	112	13,7	6000	7000	1,14	2	2	65	
NU 310 EM	50	110	27	119	125	15,2	6000	7000	1,14	2	2	65	
NUP 310 EM	50	110	27	110	112	13,7	6000	7000	1,14	2	2	65	
NUP 310 E	50	110	27	110	112	13,7	6000	7000	1,21	2	2	65	
NJ 2310 E	50	110	40	163	187	22,8	5300	6200	1,74	2	2	65	
NJ 2310 EM	50	110	40	163	187	22,8	5300	6200	1,74	2	2	65	
NJ 2310 E	50	110	40	162	187	22,8	5300	6200	1,74	2	2	65	
NU 2310 EM	50	110	40	162	187	22,8	5300	6200	1,74	2	2	65	
NUP 2310 E	50	110	40	163	186	22,7	5300	6200	1,74	2	2	65	
N 410 M	50	130	31	139	136	16,6	4800	5600	2	2,1	2,1		110,8
NJ 410 M	50	130	31	139	136	16,6	4800	5600	2,08	2,1	2,1	70,8	

Cylindrical Roller Bearing

DATA TABLE - SINGLE ROW



Part number	Principal dimensions			Basic load ratings			Speed limits		Weight	Radius		Dimensions	
	Bore	Outer	Height	Dynamic	Static	Fatigue	Grease	Oil		rs min	r1s min	F	E
	d	D	B	Cr	Cor	Pu	rpm		Kg	mm		mm	
	mm			kN			1 min ⁻¹						
NU 410 M	50	130	31	139	136	16,6	4800	5600	2	2,1	2,1	70,8	
NU 1011 M	55	90	18	37,7	43,4	5,29	7800	9200	0,46	1,1	1	64,5	
N 211 M	55	100	21	57,9	62,5	7,62	6300	7500	0,66	1,5	1,1		88,5
NJ 211 E	55	100	21	82,6	93,4	11,4	6300	7500	0,66	1,5	1,1	66	
NJ 211 EM	55	100	21	82,6	93,4	11,4	6300	7500	0,66	1,5	1,1	66	
NU 211 E	55	100	21	82,6	93,4	11,4	6300	7500	0,66	1,5	1,1	66	
NU 211 EM	55	100	21	82,6	93,4	11,4	6300	7500	0,66	1,5	1,1	66	
NUP 211 E	55	100	21	82,6	93,4	11,4	6300	7500	0,66	1,5	1,1	66	
NUP 211 EM	55	100	21	82,6	93,4	11,4	6300	7500	0,66	1,5	1,1	66	
NJ 2211 M	55	100	25	76,3	89	10,9	6300	7500	0,78	1,5	1,1	66,5	
NU 2211 EM	55	100	25	98,9	118	14,4	6300	7500	0,78	1,5	1,1	66	
NU 2211 M	55	100	25	76,3	89	10,9	6300	7500	0,78	1,5	1,1	66,5	
NUP 2211 EM	55	100	25	98,9	118	14,4	6300	7500	0,85	1,5	1,1	66	
NUP 2211 E	55	100	25	101	121,5	14,8	6300	7500	0,85	1,5	1,5	66	
NJ 2211 E	55	100	25	98,9	118	14,4	6300	7500	0,78	1,1	2	66	
NJ 2211 EM	55	100	25	98,9	118	14,4	6300	7500	0,78	1,5	1,1	66	
N 311	55	120	29	109	109	13,3	5000	6000	1,47	2	2		104,5
NJ 311 E	55	120	29	134	138	16,8	5000	6000	1,44	2	2	70,5	
NJ 311 EM	55	120	29	134	138	16,8	5000	6000	1,47	2	2	70,5	
NJ 311 M	55	120	29	109	109	13,3	5000	6000	1,47	2	2	70,5	
NU 311 EM	55	120	29	134	138	16,8	5000	6000	1,47	2	2	70,5	
NU 311 EMA	55	120	29	134	138	16,8	5000	6000	1,47	2	2	70,5	
NUP 311 E	55	120	29	134	138	16,8	5000	6000	1,47	2	2	70,5	
NUP 311 EM	55	120	29	134	138	16,8	5000	6000	1,47	2	2	70,5	
NJ 2311 EM	55	120	43	195,1	213	26,0	4800	6000	2,55	2	2	70,5	
NJ 2311 M	55	120	43	146	159	19,4	4800	5700	2,23	2	2	70,5	
NU 2311 EM	55	120	43	195,1	213	26,0	4800	5600	2,50	2	2	70,5	
NU 2311 M	55	120	43	146	159	19,4	4800	5700	2,50	2	2	70,5	
NUP 2311 EM	55	120	43	195,1	213	26,0	4800	5600	2,50	2	2	70,5	
N 411	55	140	33	139	138	16,8	4300	5000	2,54	2,1	2,1		117,2
NJ 411 M	55	140	33	139	138	16,8	4300	5000	2,54	2,1	2,1	77,2	
NU 411 M	55	140	33	139	138	16,8	4300	5000	2,54	2,1	2,1	77,2	
NUP 411	55	140	33	139	138	16,8	4300	5000	2,51	2,1	2,1	77,2	
NU 1012 EM	60	95	18	35,8	43,2	5,27	6700	8000	0,47	1,1	1	68,5	
NU 1012 M	60	95	18	35,8	43,2	5,27	6700	8000	0,48	1,1	1	69,5	
N 212 EM	60	110	22	93,4	101	12,3	5600	6700	0,82	1,5	1,5		100

Cylindrical Roller Bearing

DATA TABLE - SINGLE ROW



Part number	Principal dimensions			Basic load ratings			Speed limits		Weight	Radius		Dimensions	
	Bore	Outer	Height	Dynamic	Static	Fatigue	Grease	Oil		rs min	r1s min	F	E
	d	D	B	Cr	Cor	Pu	rpm		Kg	mm		mm	
	mm			kN			1 min ⁻¹						
NJ 212 E	60	110	22	93,4	101	12,3	5600	6700	0,82	1,5	1,5	72	
NU 212 EM	60	110	22	93,4	101	12,3	5600	6700	0,82	1,5	1,5	72	
NU 212 E	60	110	22	93,4	101	12,3	5600	6700	0,82	1,5	1,5	72	
NU 212 EM	60	110	22	96,3	106	12,9	5600	6700	0,82	1,5	1,5	72	
NUP 212 E	60	110	22	93,4	101	12,3	5600	6700	0,87	1,5	1,5	72	
NJ 2212 EM	60	110	28	139,3	158,1	19,3	5000	6000	1,08	1,5	1,5	72	
NU 2212 E	60	110	28	128	153	18,7	5000	6000	1,08	1,5	1,5	72	
NU 2212 EM	60	110	28	139,3	158,1	19,3	5000	6000	1,08	1,5	1,5	72	
NUP 2212 EM	60	110	28	136	165	20,1	5000	6000	1,08	1,5	2,1	72	
NUP 2212 E	60	110	28	136	165	20,1	5000	6000	1,08	1,5	2,1	72	
N 312 M	60	130	31	121	123	15,0	4500	5300	1,85	2,1	2,1		113
NJ 312 E	60	130	31	148	155	18,9	4500	5300	1,88	2,1	2,1	77	
NJ 312 EM	60	130	31	168,5	170,4	20,8	4500	5300	1,88	2,1	2,1	77	
NJ 312 M	60	130	31	121	123	15,0	4500	5300	1,85	2,1	2,1	77	
NU 312 E	60	130	31	148	155	18,9	4500	5300	1,83	2,1	2,1	77	
NU 312 EM	60	130	31	148	155	18,9	4500	5300	1,83	2,1	2,1	77	
NU 312 M	60	130	31	121	123	15	4500	5300	1,85	2,1	2,1	77	
NUP 312 EM	60	130	31	148	155	18,9	4500	5300	1,85	2,1	2,1	77	
NUP 312 E	60	130	31	148	155	18,9	4500	5300	1,93	2,1	2,1	77	
NUP 312 M	60	130	31	121	123	15	4500	5300	1,85	2,1	2,1	77	
N 2312	60	130	46	166	185	22,6	4300	5000	2,78	2,1	2,1		223
NJ 2312 E	60	130	46	222	262	32	4300	5000	2,77	2,1	2,1	77	
NJ 2312 EM	60	130	46	222	262	32	4300	5000	2,77	2,1	2,1	77	
NJ 2312 EMA	60	130	46	222	262	32	4300	5000	2,77	2,1	2,1	77	
NU 2312 E	60	130	46	222	262	32	4300	5000	2,78	2,1	2,1	77	
NU 2312 EM	60	130	46	222	262	32	4300	5000	2,69	2,1	2,1	77	
NU 2312 M	60	130	46	166	185	22,6	4300	5000	2,78	2,1	2,1	77	
NUP 2312 E	60	130	46	222	262	32	4300	5000	2,78	2,1	2,1	77	
NUP 2312 EM	60	130	46	222	262	32	4300	5000	2,78	2,1	2,1	77	
NUP 2312 EMA	60	130	46	222	262	32	4300	5000	2,78	2,1	2,1	77	
NJ 412 M	60	150	35	178	184	22,1	4000	4800	3,07	2,1	2,1	83	
NU 412 M	60	150	35	178	184	22,1	4000	4800	2,78	2,1	2,1	83	
NUP 412 M	60	150	35	178	184	22,1	4000	4800	3,07	2,1	2,1	83	
NU 1013 M	65	100	18	39,2	49	5,98	6600	7800	0,54	1,1	1	74,5	
N 213	65	120	23	80,5	89,7	10,9	5300	6300	1,05	1,5	1,5		105,6
NJ 213 E	65	120	23	107	118	14,4	5300	6300	1,07	1,5	1,5	78,5	

Cylindrical Roller Bearing

DATA TABLE - SINGLE ROW



Part number	Principal dimensions			Basic load ratings			Speed limits		Weight	Radius		Dimensions	
	Bore	Outer	Height	Dynamic	Static	Fatigue	Grease	Oil		rs min	r1s min	F	E
	d	D	B	Cr	Cor	Pu	rpm		Kg	mm		mm	
	mm			kN			1 min ⁻¹						
NJ 213 EM	65	120	23	107	118	14,4	5300	6300	1,07	1,5	1,5	78,5	
NU 213 E	65	120	23	107	118	14,4	5300	6300	1,05	1,5	1,5	78,5	
NU 213 EM	65	120	23	115,9	120	14,6	5300	6300	1,05	1,5	1,5	78,5	
NU 213 M	65	120	23	80,5	89,7	10,9	5300	6300	1,05	1,5	1,5	79,6	
NUP 213 EM	65	120	23	107	118	14,4	5300	6300	1,10	1,5	1,5	78,5	
NUP 213 E	65	120	23	107	118	14,4	5300	6300	1,05	1,5	1,5	78,5	
NUP 213 M	65	120	23	80,5	89,7	10,9	5300	6300	1,05	1,5	1,5	79,6	
NJ 2213 EM	65	120	31	145	178	21,7	4800	5600	1,65	1,5	1,5	78,5	
NU 2213 EM	65	120	31	145	178	21,7	4800	5600	1,65	1,5	1,5	78,5	
NUP 2213 EM	65	120	31	145	178	21,7	4800	5600	1,69	1,5	2,1	82,5	
N 313 EM	65	140	33	179	190	23	4300	5000	2,24	2,1	2,1		124,5
N 313 M	65	140	33	143	151	18,3	4300	5000	2,24	2,1	2,1		121,5
NJ 313 E	65	140	33	179	190	23	4300	5000	2,30	2,1	2,1	82,5	
NJ 313 EM	65	140	33	187,9	193,4	23,4	4300	5000	2,24	2,1	2,1	82,5	
NJ 313 M	65	140	33	143	151	18,3	4300	5000	2,24	2,1	2,1	83,5	
NU 313 E	65	140	33	179	190	23	4300	5000	2,24	2,1	2,1	78,5	
NU 313 EM	65	140	33	187,9	193,4	23,4	4300	5000	2,24	2,1	2,1	82,5	
NU 313 M	65	140	33	143	151	18,3	4300	5000	2,24	2,1	2,1	83,5	
NUP 313 E	65	140	33	179	190	23	4300	5000	2,37	2,1	2,1	82,5	
NUP 313 EM	65	140	33	179	190	23	4300	5000	2,37	2,1	2,1	82,5	
NJ 2313 EM	65	140	48	268	296,1	35,8	4000	4800	3,35	2,1	2,1	82,5	
NU 2313 E	65	140	48	245	285	34,5	4000	4800	3,31	2,1	2,1	82,5	
NU 2313 EM	65	140	48	268	296,1	35,8	4000	4800	3,31	2,1	2,1	82,5	
NUP 2313 EM	65	140	48	268	296,1	35,8	4000	4800	3,35	2,1	2,1	82,5	
NJ 413 M	65	160	37	195	203	23,9	3700	4500	3,68	2,1	2,1	89,3	
NU 413 M	65	160	37	195	203	23,9	3700	4500	3,68	2,1	2,1	89,3	
NUP 413 M	65	160	37	178,1	125,7	14,8	3700	4500	3,68	2,1	1,5	89,3	
NU 1014 M	70	110	20	57,8	69,6	8,49	6000	7000	0,73	1,1	1	80	
N 214 E	70	125	24	118	136	16,6	5000	6000	1,15	1,5	1,5		133,5
N 214 EM	70	125	24	118	136	16,6	5000	6000	1,17	1,5	1,5		133,5
NJ 214 E	70	125	24	118	136	16,6	5000	6000	1,18	1,5	1,5	83,5	
NJ 214 EM	70	125	24	118	136	16,6	5000	6000	1,18	1,5	1,5	83,5	
NU 214 E	70	125	24	118	136	16,6	5000	6000	1,17	1,5	1,5	83,5	
NU 214 EM	70	125	24	118	136	16,6	5000	6000	1,17	1,5	1,5	83,5	
NU 214 M	70	125	24	83,7	96,1	11,7	5000	6000	1,17	1,5	1,5	84,5	
NUP 214 E	70	125	24	118	136	16,6	5000	6000	1,18	1,5	1,5	83,5	

Cylindrical Roller Bearing

DATA TABLE - SINGLE ROW



Part number	Principal dimensions			Basic load ratings			Speed limits		Weight	Radius		Dimensions	
	Bore	Outer	Height	Dynamic	Static	Fatigue	Grease	Oil		rs min	r1s min	F	E
	d	D	B	Cr	Cor	Pu	rpm		Kg	mm		mm	
	mm			kN			1 min ⁻¹						
NUP 214 EM	70	125	24	118	136	16,6	5000	6000	1,18	1,5	1,5	83,5	
NJ 2214 E	70	125	31	143	174	21,2	4800	5600	1,55	1,5	1,5	83,5	
NJ 2214 EM	70	125	31	143	174	21,2	4800	5600	1,52	1,5	1,5	83,5	
NJ 2214 M	70	125	31	122	155	18,9	4800	5600	1,52	1,5	1,5	84,5	
NU 2214 E	70	125	31	143	174	21,2	4800	5600	1,52	1,5	1,5	83,5	
NU 2214 EM	70	125	31	143	174	21,2	4800	5600	1,52	1,5	1,5	83,5	
NUP 2214 E	70	125	31	143	174	21,2	4800	5600	1,57	1,5	1,5	83,5	
NUP 2214 EM	70	125	31	157	197	24	4800	5600	1,57	1,5	1,5	83,5	
N 314 M	70	150	35	149	156	18,5	4000	4800	2,80	2,1	2,1		130
NJ 314 E	70	150	35	203	220	26,1	4000	4800	2,80	2,1	2,1	89	
NJ 314 EM	70	150	35	206	226	26,8	4000	4800	2,80	2,1	2,1	89	
NJ 314 M	70	150	35	149	156	18,5	4000	4800	2,80	2,1	2,1	90	
NU 314 EM	70	150	35	206	226	26,8	4000	4800	2,80	2,1	2,1	89	
NU 314 E	70	150	35	204	222	26,3	4000	4800	2,73	2,1	1,5	89	
NU 314 M	70	150	35	149	156	18,5	4000	4800	2,80	2,1	2,1	90	
NUP 314 EM	70	150	35	206	226	26,8	4000	4800	2,80	2,1	2,1	89	
NUP 314 E	70	150	35	204	222	26,3	4000	4800	2,73	2,1	1,5	89	
NU 414 M	70	150	42	240	253	30	3400	4000	3,68	3	3	100	
NJ 2314 E	70	150	51	274	323	38,3	3800	4500	3,95	2,1	2,1	89	
NJ 2314 EM	70	150	51	295,8	332,2	39,4	3800	4500	4	2,1	2,1	89	
NJ 2314 M	70	150	51	210	242	28,7	3800	4500	4	2,1	2,1	90	
NU 2314 E	70	150	51	274	323	38,3	3800	4500	3,95	2,1	2,1	89	
NU 2314 EM	70	150	51	295,8	332,2	39,4	3800	4500	4	2,1	2,1	89	
NU 2314 M	70	150	51	210	242	28,7	3800	4500	4	2,1	2,1	90	
NUP 2314 E	70	150	51	274	323	38,3	3800	4500	3,95	2,1	2,1	89	
N 414 M	70	180	42	240	253	28,9	3400	4000	5,46	3	3		152
NJ 414 M	70	180	42	240	253	28,9	3400	4000	5,28	3	3	100	
NUP 414 M	70	180	42	240	253	28,9	3400	4000	5,46	3	3	100	
N 215 EM	75	130	25	129	155	18,8	4800	5600	1,24	1,5	1,5		118,5
NJ 215 E	75	130	25	129	155	18,8	4800	5600	1,28	1,5	1,5	88,5	
NJ 215 EM	75	130	25	129	155	18,8	4800	5600	1,27	1,5	1,5	88,5	
NU 215 E	75	130	25	129	155	18,8	4800	5600	1,28	1,5	1,5	88,5	
NU 215 EM	75	130	25	129	155	18,8	4800	5600	1,28	1,5	1,5	88,5	
NUP 215 E	75	130	25	129	155	18,8	4800	5600	1,31	1,5	1,5	88,5	
NJ 2215	75	130	31	133	167	20,2	4000	4800	1,55	1,5	1,5	88,5	
NU 2215 EM	75	130	31	151	190	23	4000	4800	1,80	1,5	1,5	88,5	

Cylindrical Roller Bearing

DATA TABLE - SINGLE ROW



Part number	Principal dimensions			Basic load ratings			Speed limits		Weight	Radius		Dimensions	
	Bore	Outer	Height	Dynamic	Static	Fatigue	Grease	Oil		rs min	r1s min	F	E
	d	D	B	Cr	Cor	Pu	rpm		Kg	mm		mm	
	mm			kN			1 min ⁻¹						
NU 2215 M	75	130	31	133	167	20,2	4000	4800	1,60	1,5	1,5	88,5	
NUP 2215	75	130	31	133	167	20,2	4000	4800	1,55	1,5	1,5	88,5	
NUP 2215 EM	75	130	31	151	190	23	4000	4800	1,80	1,5	2,1	88,5	
N 315 M	75	160	37	190	205	23,8	4000	4800	3,30	2,1	2,1		139,5
NJ 315 E	75	160	37	239	261	30,3	4000	4800	3,32	2,1	2,1	95	
NJ 315 EM	75	160	37	239	261	30,3	4000	4800	3,30	2,1	2,1	95	
NJ 315 M	75	160	37	190	205	23,8	4000	4800	3,30	2,1	2,1	95,5	
NU 315 E	75	160	37	239	261	30,3	4000	4800	3,24	2,1	2,1	95	
NU 315 EM	75	160	37	239	261	30,3	4000	4800	3,24	2,1	2,1	95	
NU 315 M	75	160	37	190	205	23,8	4000	4800	3,30	2,1	2,1	95,5	
NUP 315 E	75	160	37	239	261	30,3	4000	4800	3,30	2,1	2,1	95	
NUP 315 EM	75	160	37	239	261	30,3	4000	4800	3,30	2,1	2,1	95	
NJ 2315 EM	75	160	55	329	395	45,9	4000	4800	4,95	2,1	2,1	95	
NJ 2315 E	75	160	55	329	395	45,9	4000	4800	4,95	2,1	2,1	95	
NJ 2315 M	75	160	55	258	302	35,1	4000	4800	4,95	2,1	2,1	95,5	
NU 2315 E	75	160	55	329	302	35,1	4000	4800	4,95	2,1	2,1	95	
NU 2315 M	75	160	55	258	302	35,1	4000	4800	4,95	2,1	2,1	95,5	
NJ 415 M	75	190	45	277	294	33	4000	4800	6,44	3	3	104,5	
NU 415 M	75	190	45	277	294	33	4000	4800	6,44	3	3	104,5	
NUP 415	75	190	45	277	294	33	4000	4800	6,44	3	3	104,5	
NJ 1016 M	80	125	22	80,95	104,5	12,6	5200	6200	1	1,1	1	91,5	
NU 1016 M	80	125	22	68,2	85,3	10,3	5200	6200	1	1,1	1	91,5	
N 216 E	80	140	26	139	166	19,7	4300	5000	1,51	2	2		127,3
N 216 EM	80	140	26	139	166	19,7	4300	5000	1,51	2	2		127,3
NJ 216 EM	80	140	26	142	171	20,3	4300	5000	1,54	2	2	95,3	
NU 216 E	80	140	26	139	166	19,7	4300	5000	1,51	2	2	95,3	
NU 216 EM	80	140	26	139	166	19,7	4300	5000	1,51	2	2	95,3	
NU 216 M	80	140	26	106	122	14,5	4300	5000	1,54	2	2	95,3	
NUP 216 E	80	140	26	139	166	19,7	4300	5000	1,60	2	2	95,3	
NUP 216 M	80	140	26	119	141	16,7	3800	4800	1,78	2	2	95,3	
NJ 2216 E	80	140	33	179	231	27,4	4300	5000	2	2	2	95,3	
NJ 2216 EM	80	140	33	179	231	27,4	4300	5000	2	2	2	95,3	
NJ 2216 M	80	140	33	147	186	22	4300	5000	2	2	2	95,3	
NU 2216 EM	80	140	33	179	231	27,4	4300	5000	2	2	2	95,3	
NU 2216 M	80	140	33	147	186	22	4300	5000	2	2	2	95,3	
NUP 2216 EM	80	140	33	179	231	27,4	4300	5000	2	2	2,1	95,3	

Cylindrical Roller Bearing

DATA TABLE - SINGLE ROW



Part number	Principal dimensions			Basic load ratings			Speed limits		Weight	Radius		Dimensions	
	Bore	Outer	Height	Dynamic	Static	Fatigue	Grease	Oil		rs min	r1s min	F	E
	d	D	B	Cr	Cor	Pu	rpm		Kg	mm		mm	
	mm			kN			1 min ⁻¹						
NUP 2216 M	80	140	33	147	186	22	4300	5000	2	2	2	95,3	
N 316 M	80	170	39	190	207	23,6	3600	4300	3,93	2,1	2,1		147
NJ 316 EM	80	170	39	253	277	31,6	3600	4300	4,02	2,1	2,1	101	
NJ 316 M	80	170	39	190	207	23,6	3600	4300	3,93	2,1	2,1	103	
NU 316 E	80	170	39	253	277	31,6	3600	4300	3,93	2,1	2,1	101	
NU 316 EM	80	170	39	253	277	31,6	3600	4300	3,93	2,1	2,1	101	
NU 316 M	80	170	39	190	207	23,6	3600	4300	3,93	2,1	2,1	103	
NUP 316 M	80	170	39	190	207	23,6	3600	4300	3,93	2,1	2,1	103	
N 2316	80	170	58	274	332	37,9	3600	4300	5,89	2,1	2,1		147
NJ 2316 E	80	170	58	353	426	48,6	3600	4300	5,89	2,1	2,1	101	
NJ 2316 M	80	170	58	274	332	37,9	3400	4200	5,89	2,1	2,1	103	
NU 2316 M	80	170	58	274	332	37,9	3400	4200	5,89	2,1	2,1	103	
NU 2316 EM	80	170	58	391,4	465,9	53,1	3400	4300	6,60	2,1	2,1	103	
NUP 2316 M	80	170	58	274	332	37,9	3400	4200	5,89	2,1	2,1	103	
NJ 416 M	80	200	48	316	339	37,4	3000	3600	8,23	3	3	110	
NU 416 M	80	200	48	316	339	37,4	3000	3600	8,23	3	3	110	
NUP 416	80	200	48	316	339	37,4	3000	3600	8,23	3	3	110	
NUP 416 M	80	200	48	316	339	37,4	3000	3600	8,23	3	3	110	
N 1017 M	85	130	22	70,6	89,8	10,7	4800	5700	1,14	1,1	1		96,5
NU 1017 M	85	130	22	70,6	89,8	10,7	4800	5700	1,07	1,1	1	96,5	
N 217 M	85	150	28	121	141	16,4	4300	5000	1,90	2	2		133,8
NJ 217 E	85	150	28	164	194	22,5	4300	5000	1,95	2	2	100,5	
NJ 217 EM	85	150	28	168	200	23,2	4300	5000	1,95	2	2	100,5	
NJ 217 M	85	150	28	121	141	16,4	4300	5000	1,89	2	2	101,8	
NU 217 E	85	150	28	164	194	22,5	4300	5000	1,89	2	2	100,5	
NU 217 EM	85	150	28	164	194	22,5	4300	5000	1,89	2	2	100,5	
NU 217 M	85	150	28	121	141	16,4	4300	5000	1,89	2	2	101,8	
NUP 217 E	85	150	28	164	194	22,5	4300	5000	1,89	2	2	100,5	
NUP 217 EM	85	150	28	164	194	22,5	4300	5000	1,89	2	2	100,5	
NUP 217 M	85	150	28	121	141	16,4	4300	5000	1,89	2	2	101,8	
NJ 2217 E	85	150	36	215	274	31,8	3600	4300	2,55	2	2	100,5	
NJ 2217 EM	85	150	36	229,2	283	32,9	3600	4300	2,48	2	2	100,5	
NU 2217 EM	85	150	36	215	274	31,8	3600	4300	2,48	2	2	100,5	
NUP 2217 EM	85	150	36	219	281	32,6	3600	4300	2,90	2	2	100,5	
N 317 M	85	180	41	210	226	25,3	3400	4000	4,68	3	3		156
NJ 317 E	85	180	41	288	325	36,4	3400	4000	4,64	3	3	108	

Cylindrical Roller Bearing

DATA TABLE - SINGLE ROW



Part number	Principal dimensions			Basic load ratings			Speed limits		Weight	Radius		Dimensions	
	Bore	Outer	Height	Dynamic	Static	Fatigue	Grease	Oil		rs min	r1s min	F	E
	d	D	B	Cr	Cor	Pu	rpm		Kg	mm		mm	
	mm			kN			1 min ⁻¹						
NJ 317 EM	85	180	41	322,5	336	37,7	3400	4000	4,68	3	3	108	
NJ 317 M	85	180	41	210	226	25,3	3400	4000	4,68	3	3	108	
NU 317 EM	85	180	41	288	325	36,4	3400	4000	4,68	3	3	108	
NU 317 M	85	180	41	210	226	25,3	3400	4000	4,52	3	3	108	
NUP 317 EM	85	180	41	388	325	36,4	3400	4000	4,68	3	3	108	
NJ 2317 E	85	180	60	368	446	50	3400	4000	6,88	3	3	108	
NJ 2317 M	85	180	60	368	446	50	3400	4000	6,85	3	3	108	
NU 2317 E	85	180	60	318	386	43,3	3200	4000	7,56	3	3	108	
NU 2317 M	85	180	60	368	446	50	3400	4000	6,88	3	3	108	
NUP 2317 EM	85	180	60	368	446	50	3400	4000	6,85	3	3	108	
NJ 417 M	85	210	52	357	384	41,7	2800	3400	9,81	4	4	113	
NU 417 M	85	210	52	357	384	41,7	2800	3400	8,50	4	4	113	
NU 1018 M	90	140	24	83,8	107	12,5	4500	5300	1,40	1,5	1,1	103	
N 218 EM	90	160	30	180	215	24,5	3800	4500	2,28	2	2		145
N 218 M	90	160	30	149	174	19,8	3800	4500	2,36	2	2		143
NJ 218 E	90	160	30	180	215	24,5	3800	4500	2,34	2	2	107	
NJ 218 EM	90	160	30	195,7	226,4	25,8	3800	4500	2,36	2	2	107	
NU 218 E	90	160	30	180	215	24,5	3800	4500	2,28	2	2	107	
NU 218 EM	90	160	30	180	215	24,5	3800	4500	2,28	2	2	107	
NU 218 M	90	160	30	149	174	19,8	3800	4500	2,28	2	2	107	
NUP 218 E	90	160	30	180	215	24,5	3800	4500	2,41	2	2	107	
NUP 218 EM	90	160	30	180	215	24,5	3800	4500	2,36	2	2	107	
NJ 2218 M	90	160	40	214	277	31,6	3200	3800	3,18	2	2	107	
NU 2218 M	90	160	40	214	277	31,6	3200	3800	3,18	2	2	107	
NUP 2218 M	90	160	40	214	277	31,6	3200	3800	3,18	2	2	107	
N 318 EM	90	190	43	322	261	28,8	3200	3800	5,38	3	3		169,5
N 318 M	90	190	43	237	261	28,8	3200	3800	5,38	3	3		165
NJ 318 E	90	190	43	322	349	38,5	3200	3800	5,42	3	3	113,5	
NJ 318 EM	90	190	43	322	349	38,5	3200	3800	5,42	3	3	113,5	
NJ 318 M	90	190	43	237	261	28,8	3200	3800	5,51	3	3	115	
NU 318 E	90	190	43	322	349	38,5	3200	3800	5,38	3	3	113,5	
NU 318 EM	90	190	43	322	349	38,5	3200	3800	5,38	3	3	113,5	
NU 318 M	90	190	43	237	261	28,8	3200	3800	5,42	3	3	115	
NUP 318 E	90	190	43	322	349	38,5	3200	3800	5,42	3	3	113,5	

Cylindrical Roller Bearing

DATA TABLE - SINGLE ROW



Part number	Principal dimensions			Basic load ratings			Speed limits		Weight	Radius		Dimensions	
	Bore	Outer	Height	Dynamic	Static	Fatigue	Grease	Oil		rs min	r1s min	F	E
	d	D	B	Cr	Cor	Pu	rpm		Kg	mm		mm	
mm			kN			1 min ⁻¹							
NUP 318 EM	90	190	43	322	349	38,5	3200	3800	5,42	3	3	113,5	
NJ 2318 E	90	190	64	405	486	53,6	3000	3600	8	3	3	113,5	
NJ 2318 EM	90	190	64	454,9	538,5	59,4	3000	3600	8	3	3	113,5	
NJ 2318 M	90	190	64	342	420	46,3	3000	3600	8	3	3	115	
NU 2318 E	90	190	64	405	486	53,6	3000	3600	8	3	3	113,5	
NU 2318 EM	90	190	64	454,9	538,5	59,4	3000	3600	8	3	3	113,5	
NU 2318 M	90	190	64	342	420	46,3	3000	3600	7,90	3	3	115	
NUP 2318 E	90	190	64	405	486	53,6	3000	3600	8	3	3	115	
NUP 2318 M	90	190	64	342	420	46,3	3000	3600	8,25	3	3	115	
NJ 418 M	90	225	54	393	427	45,4	2200	2800	11,70	4	4	123,5	
NU 418 M	90	225	54	393	427	45,4	2800	3400	11,70	4	4	123,5	
NUP 418	90	225	54	393	427	45,4	2200	2800	11,70	4	4	115	
NU 1019 M	95	145	24	85,3	114	13,2	4400	5200	1,44	1,5	1,1	108	
N 219	95	170	32	166	195	21,9	3800	4500	2,83	2,1	2,1		113,5
NU 219 M	95	170	32	166	195	21,9	3800	4500	2,83	2,1	2,1	113,5	
NJ 219 EM	95	170	32	179,8	218,3	24,5	3800	4500	2,83	2,1	2,1	112,5	
NU 219 E	95	170	32	210	249	27,9	3800	4500	2,83	2,1	2,1	112,5	
NU 219 EM	95	170	32	179,8	218,3	24,5	3800	4500	2,83	2,1	2,1	112,5	
NU 219 M	95	170	32	116	195	21,9	3800	4500	2,83	2,1	2,1	113,5	
NUP 219 M	95	170	32	166	195	21,9	3800	4500	2,83	2,1	2,1	113,5	
NUP 219 EM	95	170	32	179,8	218,3	24,5	3800	4500	2,83	2,1	2,1	113,5	
NJ 2219 EM	95	170	43	272,7	348,8	39,1	3200	3800	3,93	2,1	2,1	113,5	
NJ 2219 M	95	170	43	241	317	35,5	3200	3800	3,83	2,1	2,1	113,5	
NU 2219 EM	95	170	43	272,7	348,8	39,1	3200	3800	3,93	2,1	2,1	113,5	
NU 2219 M	95	170	43	241	317	35,5	3200	3800	3,93	2,1	2,1	113,5	
NUP 2219 M	95	170	43	241	317	35,5	3200	3800	4	2,1	2,1	121,5	
N 319 M	95	200	45	255	284	30,8	3000	3600	6,28	3	3		173,5
NJ 319 E	95	200	45	331	381	41,3	3000	3600	6,28	3	3	121,5	
NJ 319 EM	95	200	45	351	370,5	40,2	3000	3600	7,15	3	3	121,5	
NJ 319 M	95	200	45	255	284	30,8	3000	3600	6,28	3	3	121,5	
NU 319 M	95	200	45	255	284	30,8	3000	3600	6,28	3	3	121,5	
NU 319 EM	95	200	45	351	370,5	40,2	3000	3600	7	3	3	121,5	
NUP 319	95	200	45	255	284	30,8	3000	3600	6,28	3	3	121,5	
N 2319 M	95	200	67	390	491	53,3	2800	3400	9,30	3	3		173,5
NJ 2319 M	95	200	67	390	491	53,3	2800	3400	10	3	3	121,5	
NJ 2319 EM	95	200	67	394	496	53,8	2800	3600	11	3	3	121,5	

Cylindrical Roller Bearing

DATA TABLE - SINGLE ROW



Part number	Principal dimensions			Basic load ratings			Speed limits		Weight	Radius		Dimensions	
	Bore	Outer	Height	Dynamic	Static	Fatigue	Grease	Oil		rs min	r1s min	F	E
	d	D	B	Cr	Cor	Pu	rpm		Kg	mm		mm	
	mm			kN			1 min ⁻¹						
NU 2319 M	95	200	67	390	491	53,3	2800	3400	3,93	3	3	121,5	
NUP 2319 M	95	200	67	390	491	53,3	2800	3400	9,30	3	3	121,5	
N 419 M	95	240	55	416	465	48,6	2500	3000	13,80	4	4		133,5
NU 419 M	95	240	55	416	465	48,6	2500	3000	13,80	4	4	133,5	
NU 1020 M	100	150	24	89,6	120	13,7	4300	5000	1,46	1,5	1,1	113	
N 220 EM	100	180	34	251	305	33,6	3200	3800	3,45	2,1	2,1		163
N 220 M	100	180	34	181	215	23,7	3400	4000	3,38	2,1	2,1		160
NJ 220 EM	100	180	34	266,5	315,8	34,8	3200	3800	3,79	2,1	2,1	119	
NJ 220 E	100	180	34	248,6	305,5	33,7	3200	3800	5,55	2,1	2,1	119	
NJ 220 M	100	180	34	181	215	23,7	3400	4000	3,44	2,1	2,1	120	
NU 220 E	100	180	34	248,6	305,5	33,7	3200	3800	3,49	2,1	2,1	119	
NU 220 EM	100	180	34	266,5	315,8	34,8	3400	4000	3,91	2,1	2,1	119	
NU 220 M	100	180	34	181	215	23,7	3400	4000	3,47	2,1	2,1	120	
NUP 220 E	100	180	34	248,6	305,5	33,7	3200	3800	3,44	2,1	2,1	120	
NUP 220 M	100	180	34	181	215	23,7	3400	4000	3,44	2,1	2,1	120	
N 2220 EM	100	180	46	336	450	49,6	3200	3800	4,90	2,1	2,1		163
NJ 2220 EM	100	180	46	326	472	52	3200	3800	5,43	2,1	2,1	119	
NJ 2220 M	100	180	46	270	360	39,7	3000	3600	4,67	2,1	2,1	120	
NU 2220 EM	100	180	46	336	450	49,6	3200	3800	4,75	2,1	2,1	120	
NU 2220 M	100	180	46	270	360	39,7	3000	3600	4,67	2,1	2,1	120	
NUP 2220 M	100	180	46	270	360	39,7	3000	3600	4,77	2,1	2,1	120	
N 320 EM	100	215	47	421,3	452,1	48,1	3000	3600	7,70	3	3		191,5
N 320 M	100	215	47	295	332	35,3	3000	3600	7,66	3	3		185,5
NJ 320 E	100	215	47	381	427	45,4	3000	3600	7,66	3	3	127,5	
NJ 320 EM	100	215	47	421,3	452,1	48,1	3000	3600	7,66	3	3	127,5	
NJ 320 M	100	215	47	295	332	35,3	3000	3600	7,70	3	3	129,5	
NU 320 EM	100	215	47	381	427	45,4	3000	3600	7,66	3	3	127,5	
NU 320 M	100	215	47	295	332	35,3	3000	3600	7,70	3	3	129,5	
NUP 320 M	100	215	47	295	332	35,3	3000	3600	7,66	3	3	129,5	
NJ 2320 E	100	215	73	568	714	76	2600	3200	12	3	3	127,5	
NJ 2320 EM	100	215	73	620,6	743,8	79,2	2600	3200	12	3	3	127,5	
NJ 2320 M	100	215	73	457	584	62,1	2600	3200	12	3	3	129,5	
NU 2320 EM	100	215	73	568	714	76	2600	3200	12	3	3	127,5	
NU 2320 M	100	215	73	457	584	62,1	2600	3200	11,90	3	3	129,5	
NUP 2320 M	100	215	73	457	584	62,1	2600	3200	14	3	3	139	
NJ 420 EM	100	250	58	429	475	49	2400	3000	14	4	4	139	

Cylindrical Roller Bearing

DATA TABLE - SINGLE ROW



Part number	Principal dimensions			Basic load ratings			Speed limits		Weight	Radius		Dimensions	
	Bore	Outer	Height	Dynamic	Static	Fatigue	Grease	Oil		rs min	r1s min	F	E
	d	D	B	Cr	Cor	Pu	rpm		Kg	mm		mm	
	mm			kN			1 min ⁻¹						
NJ 420 M	100	250	58	440	488	50,3	2200	2800	15,70	4	4	119,5	
NU 420 EM	100	250	58	429	475	49	2400	3000	14	4	4	139	
NU 420 M	100	250	58	440	488	50,3	2200	2800	14	4	4	139	
NU 1021 M	105	160	26	101,5	135,3	15,2	3800	4500	1,95	2	1,1	126,8	
N 221 M	105	190	36	210	256	27,8	3200	3800	4,04	2,1	2,1		126,8
NJ 221 M	105	190	36	210	256	27,8	3200	3800	4,04	2,1	2,1	168,8	
NU 221 M	105	190	36	210	256	27,8	3200	3800	4,04	2,1	2,1	126,8	
N 321 M	105	225	49	354	408	42,8	2400	3000	9,09	3	3		195
NJ 321 M	105	225	49	354	408	42,8	2400	3000	9,09	3	3	135	
NU 321 EM	105	225	49	418	469	49,2	2400	3000	9,09	3	3	133	
NJ 421 M	105	260	60	488	545	55,5	2200	2800	17,40	4	4	144,5	
NU 421 M	105	260	60	488	545	55,5	2200	2800	17,40	4	4	144,5	
NUP 421 M	105	260	60	488	545	55,5	2200	2800	19,50	4	4	144,5	
NU 1022 M	110	170	28	127	167	18,4	3600	4500	2,31	2	1,1	125	
N 222 M	110	200	38	238	287	30,7	3000	3600	4,65	2,1	2,1		178,5
NJ 222 E	110	200	38	279	343	36,7	3000	3600	4,77	2,1	2,1	132,5	
NJ 222 EM	110	200	38	321,7	375,8	40,2	3000	3600	4,85	2,1	2,1	132,5	
NJ 222 M	110	200	38	238	287	30,7	3000	3600	4,65	2,1	2,1	132,5	
NU 222 EM	110	200	38	312,7	375,8	40,2	3000	3600	4,77	2,1	2,1	132,5	
NU 222 M	110	200	38	238	287	30,7	3000	3600	4,65	2,1	2,1	132,5	
NUP 222 E	110	200	38	279	343	36,7	3000	3600	4,85	2,1	2,1	132,5	
NUP 222 EM	110	200	38	312,7	375,8	40,2	3000	3600	4,85	2,1	2,1	132,5	
NUP 222 M	110	200	38	238	287	30,7	3000	3600	4,65	2,1	2,1	132,5	
N 2222 EM	110	200	53	348	513	54,9	2800	3400	7,10	2,1	2,1		180,5
NJ 2222 EM	110	200	53	383	516	55,2	2800	3200	6,68	2,1	2,1	132,5	
NJ 2222 M	110	200	53	350	471	50,4	2600	3200	6,68	2,1	2,1	132,5	
NU 2222 EM	110	200	53	383	516	55,2	2800	3400	6,68	2,1	2,1	132,5	
NU 2222 M	110	200	53	350	471	50,4	2600	3200	6,68	2,1	2,1	132,5	
NUP 2222 M	110	200	53	350	471	50,4	2600	3200	7,14	2,1	2,1	132,5	
N 322 EM	110	240	50	409,4	575,3	59,3	2000	2600	11,34	3	3		211
NJ 322 E	110	240	50	443	513	52,9	2400	3000	10,60	3	3	143	
NJ 322 EM	110	240	50	443	513	52,9	2400	3000	10,60	3	3	143	
NJ 322 M	110	240	50	382	437	45,1	2400	3000	10,60	3	3	143	
NU 322 E	110	240	50	443	513	52,9	2400	3000	10,60	3	3	143	
NU 322 EM	110	240	50	443	513	52,9	2400	3000	10,60	3	3	143	
NU 322 M	110	240	50	382	437	45,1	2400	3000	10,60	3	3	143	

Cylindrical Roller Bearing

DATA TABLE - SINGLE ROW



Part number	Principal dimensions			Basic load ratings			Speed limits		Weight	Radius		Dimensions	
	Bore	Outer	Height	Dynamic	Static	Fatigue	Grease	Oil		rs min	r1s min	F	E
	d	D	B	Cr	Cor	Pu	rpm		Kg	mm	mm	mm	
	mm			kN			1 min ⁻¹			mm		mm	
NUP 322 E	110	240	50	443	513	52,9	2400	3000	10,60	3	3	143	
NUP 322 EM	110	240	50	485	577	59,5	2400	3000	10,60	3	3	143	
NUP 322 M	110	240	50	382	437	45,1	2400	3000	10,60	3	3	143	
N 2322 EM	110	240	80	682	900	92,8	2000	2600	18,23	3	3		211
N 2322 M	110	240	80	603	789	81,3	2200	2800	16,90	3	3		207
NJ 2322 E	110	240	80	667	868	89,5	2200	2800	16,90	3	3	143	
NJ 2322 EM	110	240	80	667	868	89,5	2200	2800	16,90	3	3	143	
NJ 2322 M	110	240	80	603	789	81,3	2200	2800	16,90	3	3	143	
NU 2322 EM	110	240	80	667	868	89,5	2200	2800	19	3	3	143	
NU 2322 M	110	240	80	603	789	81,3	2200	2800	16,90	3	3	143	
NUP 2322 M	110	240	80	604	789	81,3	2200	2800	16,90	3	3	143	
NJ 422 EM	110	280	65	523	585	58,4	2000	2600	20	4	4	155	
NJ 422 M	110	280	65	583	672	67,1	2200	2800	20,80	4	4	155	
NU 422 EM	110	280	65	523	585	58,4	2000	2600	20	4	4	155	
NU 422 M	110	280	65	583	672	67,1	2200	2800	20,80	4	4	155	
NUP 422 M	110	280	65	583	672	67,1	2200	2400	20,80	4	4	155	
NJ 323 M	115	250	53	476	547	55,7	2700	3300	13,30	3	3	149,5	
N 1024 M	120	180	28	177,1	262,5	28,3	3400	4000	2,55	2	1,1		165
NU 1024 M	120	180	28	177,1	262,5	28,3	3400	4000	2,55	2	1,1	135	
N 224 EM	120	215	40	370,5	461	48,2	2400	3000	6,30	2,1	2,1		195,5
N 224 M	120	215	40	258	361	37,7	2800	3400	5,65	2,1	2,1		191,5
NJ 224 E	120	215	40	331	415	43,4	2800	3400	5,80	2,1	2,1	143,5	
NJ 224 EM	120	215	40	370,5	461	48,2	2800	3400	5,54	2,1	2,1	143,5	
NJ 224 M	120	215	40	258	361	37,7	2800	3400	5,54	2,1	2,1	143,5	
NU 224 EM	120	215	40	370,5	461	48,2	2400	3000	6,35	2,1	2,1	143,5	
NU 224 M	120	215	40	258	361	37,7	2800	3400	5,65	2,1	2,1	143,5	
NUP 224 M	120	215	40	258	361	37,7	2800	3400	5,65	2,1	2,1	143,5	
NUP 224 EM	120	215	40	370,5	461	48,2	2800	3400	5,65	2,1	2,1	143,5	
NJ 224 EM	120	215	58	491,7	640,7	66,9	2400	3000	9,53	2,1	2,1	143,5	
NJ 224 M	120	215	58	382	523	54,6	2400	3000	8,29	2,1	2,1	143,5	
NU 224 EM	120	215	58	491,7	640,7	66,9	2400	3000	9	2,1	2,1	143,5	
NU 224 M	120	215	58	382	523	54,6	2400	3000	8,29	2,1	2,1	143,5	
NUP 224 M	120	215	58	382	523	54,6	2400	3000	8,29	2,1	2,1	143,5	
N 324 EM	120	260	55	549	644	64,8	2200	2800	13,10	3	3		230
N 324 M	120	260	55	441	498	50,1	2200	2800	13,10	3	3		226
NJ 324 EM	120	260	55	549	644	64,8	2200	2800	13,30	3	3	154	

Cylindrical Roller Bearing

DATA TABLE - SINGLE ROW



Part number	Principal dimensions			Basic load ratings			Speed limits		Weight	Radius		Dimensions	
	Bore	Outer	Height	Dynamic	Static	Fatigue	Grease	Oil		rs min	r1s min	F	E
	d	D	B	Cr	Cor	Pu	rpm	Kg	mm				
mm			kN			1 min ⁻¹							
NJ 324 M	120	260	55	441	498	50,1	2200	2800	13,30	3	3	154	
NU 324 EM	120	260	55	549	644	64,8	2200	2800	13,30	3	3	154	
NU 324 M	120	260	55	441	498	50,1	2200	2800	13,40	3	3	154	
NUP 324 EM	120	260	55	549	644	64,8	2200	2800	13,70	3	3	154	
NUP 324 M	120	260	55	441	498	50,1	2200	2800	13,10	3	3	154	
NJ 2324 EM	120	260	86	765,7	1080,9	109	1900	2400	24,03	3	3	154	
NJ 2324 M	120	260	86	702	907	91,2	2000	2600	23,20	3	3	154	
NU 2324 EM	120	260	86	765,7	1080,9	109	1900	2400	23,71	3	3	154	
NU 2324 M	120	260	86	702	907	91,2	2000	2600	23,20	3	3	154	
NUP 2324 M	120	260	86	702	907	91,2	2000	2600	24	3	3	154	
N 424 M	120	310	72	677	776	75,2	1800	2200	30,60	5	5		260
NJ 424 EM	120	310	72	644	735	71,2	1900	2400	28,50	5	5	170	
NJ 424 M	120	310	72	677	776	75,2	1800	2200	30,60	5	5	260,	
NU 424 EM	120	310	72	644	735	71,2	1900	2400	28	5	5	170	
NU 424 M	120	310	72	677	776	75,2	1800	2200	30,60	5	5	260	
NJ 1026 M	130	200	33	162	221	23,2	3000	3600	3,91	2	1,1	148	
NU 1026 M	130	200	33	163	221	23,2	3000	3600	3,91	2	1,1	148	
N 226 EM	130	230	40	326	446	45,6	2200	2800	7	3	3		209,5
N 226 M	130	230	40	268	339	34,7	2400	3000	6,79	3	3		204
NJ 226 E	130	230	40	356	443	45,3	2400	3000	6,79	3	3	153,5	
NJ 226 EM	130	230	40	356	443	45,3	2400	3000	6,79	3	3	153,5	
NJ 226 M	130	230	40	268	339	34,7	2400	3000	6,49	3	3	156	
NU 226 EM	130	230	40	356	443	45,3	2400	3000	6,50	3	3	153,5	
NU 226 M	130	230	40	268	339	34,7	2400	3000	6,64	3	3	156	
NUP 226 M	130	230	40	268	339	34,7	2400	3000	6,79	3	3	156	
NJ 2226 EM	130	230	64	574,5	760,5	77,8	2200	2800	10,30	3	3	153,5	
NJ 2226 M	130	230	64	395	560	57,3	2200	2800	10,30	3	3	156	
NJ 2226 MA	130	230	64	395	560	57,3	2200	2800	11,10	3	3	156	
NU 2226 EM	130	230	64	574,5	760,5	77,8	2200	2800	10,30	3	3	153,5	
NU 2226 M	130	230	64	395	560	57,3	2200	2800	10,30	3	3	156	
NUP 2226 M	130	230	64	395	560	57,3	2200	2800	10,30	3	3	156	
N 326 EM	130	280	58	607	722	71	2000	2600	16,40	4	4		247
N 326 M	130	280	58	520	607	59,7	2000	2600	16,50	4	4		243
NJ 326 E	130	280	58	607	722	71	2000	2600	16,80	4	4	167	
NJ 326 EM	130	280	58	676,7	773,5	76,1	2000	2600	18,50	4	4	167	
NJ 326 M	130	280	58	520	607	59,7	2000	2600	16,50	4	4	167	

Cylindrical Roller Bearing

DATA TABLE - SINGLE ROW



Part number	Principal dimensions			Basic load ratings			Speed limits		Weight	Radius		Dimensions	
	Bore	Outer	Height	Dynamic	Static	Fatigue	Grease	Oil		rs min	r1s min	F	E
	d	D	B	Cr	Cor	Pu	rpm		Kg	mm		mm	
	mm			kN			1 min ⁻¹						
NU 326 E	130	280	58	607	722	71	2000	2600	16,50	4	4	167	
NU 326 EM	130	280	58	676,7	773,5	76,1	2000	2600	16,50	4	4	167	
NU 326 M	130	280	58	520	607	59,7	2000	2600	16,50	4	4	167	
NUP 326 E	130	280	58	607	722	71	2000	2600	16,50	4	4	167	
NUP 326 EM	130	280	58	676,7	773,5	76,1	2000	2600	16,40	4	4	167	
NUP 326 M	130	280	58	520	607	59,7	2000	2600	16,90	4	4	167	
NJ 2326 EM	130	280	93	924	1212	119	1900	2400	29,60	4	4	167	
NJ 2326 M	130	280	93	828	1106	109	1900	2400	29,44	4	4	167	
NU 2326 EM	130	280	93	924	1212	119	1900	2400	29,60	4	4	167	
NU 2326 M	130	280	93	828	1106	109	1900	2400	29,60	4	4	167	
NUP 2326	130	280	93	828	1106	109	1900	2400	29,60	4	4	167	
NU 426 M	130	340	78	880	1040	98,2	1800	2200	39,10	5	5		
NJ 1028 M	140	210	33	172	243	25,1	2800	3200	4,10	2	1,1	158	
NU 1028 M	140	210	33	229,8	351,2	36,2	2800	3200	4,10	2	1,1	158	
N 228 EM	140	250	42	399	571	57	2000	2600	9	3	3		
NJ 228 EM	140	250	42	437,4	571	57	2000	2600	8,55	3	3	169	
NJ 228 M	140	250	42	307	391	39	2200	2800	8,55	3	3	169	
NU 228 EM	140	250	42	437,4	571	57	2200	2800	8,35	3	3	169	
NU 228 M	140	250	42	307	391	39	2200	2800	8,35	3	3	169	
NUP 228 EM	140	250	42	437,4	571	57	2200	2800	8,55	3	3	169	
NUP 228 M	140	250	42	307	391	39	2200	2800	8,55	3	3	169	
NJ 2228 EM	140	250	68	594,2	816,6	81,5	2000	2600	13,70	3	3	169	
NJ 2228 M	140	250	68	479	708	70,7	2000	2600	15,20	3	3	169	
NU 2228 EM	140	250	68	594,2	816,6	81,5	2000	2600	15,20	3	3	169	
NU 2228 M	140	250	68	479	708	70,7	2000	2600	15,20	3	3	169	
NUP 2228 M	140	250	68	479	708	70,7	2000	2600	15,20	3	3	169	
N 328 EM	140	300	62	610	1214	117	1800	2200	22	4	4		260
N 328 M	140	300	62	607	732	70,5	1900	2400	20,10	4	4		260
NJ 328 EM	140	300	62	677	818	78,7	1800	2200	22,45	4	4	180	
NJ 328 M	140	300	62	607	732	70,5	1900	2400	22,50	4	4	180	
NU 328 EM	140	300	62	703	861	82,9	1900	2400	20,20	4	4	180	
NU 328 M	140	300	62	607	732	70,5	1900	2400	20,20	4	4	180	
NUP 328 EM	140	300	62	703	861	82,9	1900	2400	20,10	4	4	180	
NUP 328 M	140	300	62	607	732	70,5	1900	2400	20,70	4	4	180	
NJ 2328 E	140	300	102	1130	1589	153	1800	2200	37,20	4	4	180	
NJ 2328 EM	140	300	102	1130	1589	153	1800	2200	37,20	4	4	180	

Cylindrical Roller Bearing

DATA TABLE - SINGLE ROW



Part number	Principal dimensions			Basic load ratings			Speed limits		Weight	Radius		Dimensions				
	Bore	Outer	Height	Dynamic	Static	Fatigue	Grease	Oil		rs min	r1s min	F	E			
	d	D	B	Cr	Cor	Pu	rpm	Kg	mm					mm		
													1 min ⁻¹			
NJ 2328 M	140	300	102	913	1236	119	1800	2200	37,20	4	4	180				
NU 2328 M	140	300	102	1060	1500	144	1800	2200	36,10	4	4	180				
NU 2328 M	140	300	102	913	1236	119	1800	2200	37,20	4	4	180				
NUP 2328 M	140	300	102	913	1236	119	1800	2200	37,20	4	4	180				
N 428 EM	140	360	82	868	1010	93,6	1300	1700	43,80	4	4					
NJ 428 EM	140	360	82	868	1010	93,6	1300	1700	44,76	4	4	182				
NU 428 EM	140	360	82	868	1010	93,6	1300	1700	44,07	4	4	182				
NU 1030 M	150	225	35	190	271	27,4	2600	3200	4,83	2,1	1,5	169,5				
N 230 EM	150	270	45	454,2	574,1	56	1900	2400	11,20	3	3	242				
N 230 M	150	270	45	370	484	47,2	2000	2600	10,30	3	3		238			
NJ 230 EM	150	270	45	454,2	574,1	56	2200	2800	10,60	3	3	182				
NJ 230 M	150	270	45	370	484	47,2	2000	2600	10,60	3	3	182				
NU 230 EM	150	270	45	454,2	574,1	56	2200	2800	11,68	3	3	182				
NU 230 M	150	270	45	370	484	47,2	2000	2600	10,30	3	3	182				
NU 230 MA	150	270	45	370	484	47,2	2000	2600	10,30	3	3	182				
NUP 230 M	150	270	45	370	484	47,2	2000	2600	10,90	3	3	182				
NJ 2230 EM	150	270	73	573,7	922	90	1900	2400	18,61	3	3	182				
NJ 2230 M	150	270	73	565	836	81,6	1900	2400	19,20	3	3	182				
NU 2230 EM	150	270	73	573,7	922	90	1900	2400	18,25	3	3	182				
NU 2230 M	150	270	73	565	836	81,6	1900	2400	18,70	3	3	182				
NUP 2230 M	150	270	73	565	836	81,6	1900	2400	18,50	3	3	182				
N 330 EM	150	320	65	688	921	86,9	1700	2000	25,78	4	4		283			
NJ 330 EM	150	320	65	688	921	86,9	1700	2000	26,32	4	4	193				
NJ 330 M	150	320	65	667	813	76,7	1700	2000	27	4	4	193				
NU 330 EM	150	320	65	798	988	93,2	1700	2000	27	4	4	193				
NU 330 M	150	320	65	667	813	76,7	1700	2000	27	4	4	193				
NUP 330 M	150	320	65	667	813	76,7	1700	2000	27,40	4	4	193				
NJ 2330 EM	150	320	108	1055	1607	152	1700	2000	43,50	4	4	193				
NJ 2330 M	150	320	108	1022	1409	133	1700	2000	44,70	4	4	193				
NU 2330 EM	150	320	108	1055	1607	152	1700	2000	42,98	4	4	193				
NU 2330 M	150	320	108	1022	1409	133	1700	2000	44,70	4	4	193				
NJ 1032 M	160	240	38	230	331	32,8	2400	3000	6,20	2,1	1,5	180				
NU 1032 M	160	240	38	230	328	32,5	2400	3000	6,20	2,1	1,5	180				
N 232 EM	160	290	48	351	479	45,8	1800	2200	14	3	3		259			
NJ 232 EM	160	290	48	553,7	711,4	68	1900	2400	14,60	3	3	195				
NJ 232 M	160	290	48	440	591	56,5	1900	2400	14,60	3	3	195				

Cylindrical Roller Bearing

DATA TABLE - SINGLE ROW



Part number	Principal dimensions			Basic load ratings			Speed limits		Weight	Radius		Dimensions	
	Bore	Outer	Height	Dynamic	Static	Fatigue	Grease	Oil		rs min	r1s min	F	E
	d	D	B	Cr	Cor	Pu	rpm		Kg	mm		mm	
	mm			kN			1 min ⁻¹						
NU 232 EM	160	290	48	553,7	711,4	68	1900	2400	14,60	3	3	195	
NU 232 M	160	290	48	440	591	56,5	1900	2400	14,60	3	3	195	
NUP 232 EM	160	290	48	553,7	711,4	68	1900	2400	14,60	3	3	195	
NUP 232 M	160	290	48	440	591	56,5	1900	2400	14,60	3	3	195	
NJ 2232 EM	160	290	80	767	1109	106	1700	2000	24,30	3	3	193	
NJ 2232 M	160	290	80	650	978	93,5	1700	2000	24,30	3	3	195	
NU 2232 EM	160	290	80	706	1128	108	1800	2200	23,30	3	3	193	
NU 2232 M	160	290	80	650	978	93,5	1700	2000	24,30	3	3	195	
NUP 2232 M	160	290	80	650	978	93,5	1700	2000	24,30	3	3	195	
N 332 EM	160	340	68	738	978	90,6	1500	1800	30,30	4	4		300
N 332 M	160	340	68	702	883	81,8	1500	1800	32	4	4		292
NJ 332 EM	160	340	68	738	978	90,6	1500	1800	31	4	4	204	
NJ 332 M	160	340	68	702	883	81,8	1600	1900	31,70	4	4	208	
NU 332 EM	160	340	68	738	978	90,6	1500	1800	30,56	4	4	204	
NU 332 M	160	340	68	702	883	81,8	1600	1900	31,70	4	4	208	
NUP 332 M	160	340	68	702	883	81,8	1600	1900	32	4	4	208	
NJ 2332 EM	160	340	114	1128	1689	156	1500	1800	51,50	4	4	204	
NJ 2332 M	160	340	114	1069	1522	141	1600	1900	53,20	4	4	208	
NU 2332 EM	160	340	114	1128	1689	156	1500	1800	50,98	4	4	204	
NU 2332 M	160	340	114	1069	1522	141	1600	1900	53,20	4	4	208	
NJ 1034 M	170	260	42	277	400	38,8	2200	2800	8,36	2,1	2,1	193	
NU 1034 M	170	260	42	277	400	38,8	2200	2800	7,90	2,1	2,1	193	
N 234 EM	170	310	52	638,2	828	77,7	1800	2200	17,60	4	4		272
NJ 234 EM	170	310	52	638,2	828	77,7	1800	2200	17,96	4	4	207	
NJ 234 M	170	310	52	499	677	63,5	1800	2200	18,20	4	4	208	
NU 234 EM	170	310	52	618	828	77,7	1800	2200	17,60	4	4	207	
NU 234 M	170	310	52	499	677	63,5	1800	2200	18,10	4	4	208	
NUP 234 M	170	310	52	499	677	63,5	1800	2200	18,20	4	4	208	
N 2234 M	170	310	86	748	1141	107	1700	2000	29,80	4	4		272
NJ 2234 EM	170	310	86	820	1340	126	1800	2200	30,10	4	4	205	
NU 2234 EM	170	310	86	914	1316	123	1700	2000	28,57	4	4	205	
NU 2234 M	170	310	86	748	1141	107	1700	2000	29,80	4	4	208	
NUP 2234 EM	170	310	86	914	1316	123	1700	2000	29,80	4	4	205	
NUP 2234 M	170	310	86	748	1141	107	1700	2000	29,80	4	4	208	
N 334 EM	170	360	72	809	1040	94,7	1400	1700	38,45	4	4		318
NJ 334 EM	170	360	72	928	1149	105	1500	1800	38	4	4	215	

Cylindrical Roller Bearing

DATA TABLE - SINGLE ROW



Part number	Principal dimensions			Basic load ratings			Speed limits		Weight	Radius		Dimensions	
	Bore	Outer	Height	Dynamic	Static	Fatigue	Grease	Oil		rs min	r1s min	F	E
	d	D	B	Cr	Cor	Pu	rpm	Kg	mm				
mm			kN			1 min ⁻¹							
NJ 334 M	170	360	72	801	1018	92,7	1500	1800	38	4	4	220	
NU 334 EM	170	360	72	809	1040	94,7	1400	1700	38,50	4	4	218	
NU 334 M	170	360	72	801	1018	92,7	1500	1800	38	4	4	220	
NUP 334	170	360	72	801	1018	92,7	1600	1900	38	4	4	220	
NJ 2334 EM	170	360	120	1310	2030	185	1400	1700	63,10	4	4	216	
NJ 2334 M	170	360	120	1226	1758	160	1400	1700	62,70	4	4	220	
NU 2334 EM	170	360	120	1310	2030	185	1400	1700	61,30	4	4	216	
NU 2334 M	170	360	120	1226	1758	160	1400	1700	62,70	4	4	220	
N 1036 M	180	280	46	436	550,7	52,3	2000	2600	10,90	2,1	2,1		255
NJ 1036 M	180	280	46	436	550,7	52,3	2000	2600	10,90	2,1	2,1	205	
NU 1036 M	180	280	46	436	550,7	52,3	2000	2600	10,90	2,1	2,1	205	
N 236 EM	180	320	52	541,4	797,2	73,9	1700	2000	18,17	4	4		
N 236 M	180	320	52	516	717	66,4	1800	2200	18,80	4	4		218
NJ 236 EM	180	320	52	541,4	797,2	73,9	1700	2000	18,45	4	4	217	
NJ 236 M	180	320	52	516	717	66,4	1800	2200	18,70	4	4	218	
NU 236 EM	180	320	52	541,4	797,2	73,9	1700	2000	18,16	4	4	217	
NU 236 M	180	320	52	516	717	66,4	1800	2200	18,80	4	4	218	
NUP 236 M	180	320	52	516	717	66,4	1800	2200	18,80	4	4	218	
NJ 2236 E	180	320	86	955	1408	130	1600	1900	31,10	4	4	215	
NJ 2236 EM	180	320	86	955	1408	130	1600	1900	31,1	4	4	215	
NJ 2236 M	180	320	86	775	1208	112	1600	1900	31,10	4	4	218	
NU 2236 EM	180	320	86	955	1408	130	1600	1900	30,50	4	4	215	
NU 2236 M	180	320	86	775	1208	112	1600	1900	31,10	4	4	218	
NUP 2236 EM	180	320	86	955	1408	130	1600	1900	31,10	4	4	215	
NUP 2236 M	180	320	86	775	1208	112	1600	1900	31,10	4	4	218	
N 336 M	180	380	75	903	1155	103	1500	1800	43,40	4	4		328
NJ 336 M	180	380	75	903	1155	103	1500	1800	43,40	4	4	232	
NU 336 EM	180	380	75	913	1180	106	1500	1800	42,50	4	4	231	
NU 336 M	180	380	75	903	1155	103	1500	1800	43,40	4	4	232	
NUP 336 M	180	380	75	903	1155	103	1500	1800	43,40	4	4	232	
NU 2336 EM	180	380	126	1400	2040	183	1300	1600	73	4	4	231	
NU 2336 M	180	380	126	1380	1995	179	1300	1600	73,90	4	4	232	
NJ 1938 M	190	260	33	251	400	38,2	1800	2340	5,50	1	2	209	
NJ 1038 M	190	290	46	450,9	714,4	67	1900	2200	11,40	2,1	2,1	215	
NU 1038 M	190	290	46	450,9	714,4	67	1900	2200	11,40	2,1	2,1	215	
N 238 EM	190	340	55	733,9	953,9	86,8	1600	1900	21,74	4	4		299

Cylindrical Roller Bearing

DATA TABLE - SINGLE ROW



Part number	Principal dimensions			Basic load ratings			Speed limits		Weight	Radius		Dimensions	
	Bore	Outer	Height	Dynamic	Static	Fatigue	Grease	Oil		rs min	r1s min	F	E
	d	D	B	Cr	Cor	Pu	rpm		Kg	mm		mm	
	mm			kN			1 min ⁻¹						
N 238 M	190	340	55	567	790	71,9	1700	2000	22,50	4	4		299
NJ 238 EM	190	340	55	733,9	953,9	86,8	1600	1900	21,89	4	4	230	
NJ 238 M	190	340	55	567	790	71,9	1700	2000	22,70	4	4	231	
NU 238 EM	190	340	55	733,9	953,9	86,8	1700	2000	22,50	4	4	230	
NU 238 M	190	340	55	567	790	71,9	1700	2000	22,70	4	4	231	
NUP 238 M	190	340	55	567	790	71,9	1700	2000	23,10	4	4	231	
NJ 2238 M	190	340	92	854	1338	122	1500	1800	37,80	4	4	231	
NU 2238 EM	190	340	92	1100	1660	151	1600	1900	39	4	4	231	
NU 2238 M	190	340	92	854	1338	122	1500	1800	36,74	4	4	231	
NJ 338 M	190	400	78	1036	1329	117	1400	1700	50,50	5	5	243	
NU 338 EM	190	400	78	1150	1489	131	1400	1700	50,50	5	5	245	
NU 338 M	190	400	78	1036	1329	117	1400	1700	50,50	5	5	243	
NU 2338 EM	190	400	132	1789	2628	232	1300	1600	85,50	5	5	245	
NU 1940 EM	200	280	38	264	405	38	2200	2800	7,40	2,1	2,1	221	
NJ 1940 MA	200	280	38	264	405	38	2200	2800	7,40	2,1	2,1	221	
NJ 1040 M	200	310	51	395	590	54,3	2000	2600	14,80	2,1	2,1	229	
NU 1040 M	200	310	51	395	590	54,3	2000	2600	14,80	2,1	2,1	229	
NUP 1040 M	200	310	51	395	590	54,3	2000	2600	14,80	2,1	2,1	229	
N 240 EM	200	360	58	663	996	89,2	1500	1800	26,56	4	4		
N 240 M	200	360	58	634	892	79,9	1600	1900	26,50	4	4		316
NJ 240 EM	200	360	58	720	979	87,7	1600	1900	26,90	4	4	243	
NJ 240 M	200	360	58	634	892	79,9	1600	1900	26,90	4	4	244	
NU 240 EM	200	360	58	663	996	89,2	1500	1800	26,42	4	4	243	
NU 240 M	200	360	58	634	892	79,9	1600	1900	26,50	4	4	244	
NUP 240 M	200	360	58	634	892	79,9	1600	1900	27,50	4	4	244	
NJ 2240 EM	200	360	98	1220	1860	167	1400	1700	45,50	4	4	241	
NU 2240 EM	200	360	98	1220	1860	167	1400	1700	45,50	4	4	241	
NU 2240 M	200	360	98	1220	1860	167	1400	1700	45,50	4	4		
N 340 EM	200	420	80	1250	1678	146	1300	1600	56,20	5	5		368
NJ 340 EM	200	420	80	1250	1648	143	1300	1600	57,10	5	5	260	
NJ 340 M	200	420	80	974	1273	111	1300	1600	57,10	5	5	260	
NU 340 EM	200	420	80	1250	1648	143	1300	1600	56	5	5	260	
NU 340 M	200	420	80	974	1273	111	1300	1600	57,10	5	5	260	
NU 2340 EM	200	420	138	1740	2685	233	1200	1500	97	5	5	247	
NU 2340 M	200	420	138	1740	2685	233	1200	1500	97	5	5	260	
NJ 1944 M	220	300	38	336	560	51,3	2400	3000	8,30	2,1	2,1	250	

Cylindrical Roller Bearing

DATA TABLE - SINGLE ROW



Part number	Principal dimensions			Basic load ratings			Speed limits		Weight	Radius		Dimensions	
	Bore	Outer	Height	Dynamic	Static	Fatigue	Grease	Oil		rs min	r1s min	F	E
	d	D	B	Cr	Cor	Pu	rpm		Kg	mm		mm	
mm			kN			1 min ⁻¹							
NJ 1044 M	220	340	56	650	1047	93,8	1300	1600	19,30	3	3	250	
NU 1044 M	220	340	56	650	1047	93,8	1300	1600	18,50	3	3	250	
N 244 EM	220	400	65	725	1110	96,4	1500	1800	36,45	4	4		270
N 244 M	220	400	65	778	1113	96,7	1400	1700	38,50	4	4		350
NJ 244 EM	220	400	65	725	1110	96,4	1500	1800	37,10	4	4	268	
NJ 244 M	220	400	65	778	1113	96,7	1400	1700	38,10	4	4	270	
NU 244 EM	220	400	65	725	1110	96,4	1500	1800	36,40	4	4	268	
NU 244 M	220	400	65	778	1113	96,7	1400	1700	38	4	4	270	
NUP 244 M	220	400	65	778	113	9,81	1400	1700	38,50	4	4	270	
NU 2244 EM	220	400	108	1570	2280	198	1300	1600	62,50	4	4	259	
NU 2244 M	220	400	108	1370	2310	201	1400	1700	61,50	4	4	270	
NUP 2244 M	220	400	108	1370	2310	201	1400	1700	61,50	4	4	270	
N 344 EM	220	460	88	1130	1160	98	1200	1500	72,21	4	4		
NJ 344 EM	220	460	88	1130	1160	98	1200	1500	72,72	4	4	284	
NU 344 EM	220	460	88	1130	1160	98,0	1200	1500	72,34	4	4	284	
NJ 2344 M	220	460	145	2425	3750	317	1400	1700	125	5	5	280	
NU 2344 EM	220	460	145	2425	3750	317	1400	1700	125	5	5	277	
NU 2344 M	220	460	145	2425	3750	317	1400	1700	125	5	5	280	
NUP 2344 M	220	460	145	2425	3750	317	1400	1700	120	5	5	280	
NU 1948 M	240	320	38	308	540	48,4	1900	2400	8,50	2,5	1,8	260	
NU 1048 M	240	360	56	520	820	71,9	1700	2000	20	3	3	270	
NJ 1048 M	240	360	56	512	775	68	1700	2000	21,10	3	3	270	
NU 248 M	240	440	72	1050	1540	130	1300	1600	46,90	4	4	295	
NJ 248 M	240	440	72	1050	1540	130	1300	1600	49,60	4	4	295	
NU 2248 M	240	440	120	1490	2450	207	1200	1500	84,80	4	4	295	
N 348 M	240	500	95	1530	2120	175	1000	1300	96,30	5	5		430
NU 348 M	240	500	95	1530	2120	175	1000	1300	96,30	5	5	310	
NU 2348 M	240	500	155	2190	3360	277	950	1200	155	5	5	310	
NU 1052 M	260	400	65	688	1090	92,9	1500	1800	30,20	4	4	347	
NUP 1052 M	260	400	65	688	1090	92,9	1500	1800	28,70	4	4	296	
NJ 1052 M	260	400	65	688	1090	92,9	1500	1800	30,10	4	4	296	
NU 2052 EM	260	400	82	1080	1880	160	1300	1700	40,10	4	4	294	
NU 3052 M	260	400	104	1350	2340	199	1150	1450	49,50	4	4	290	
NU 3152 M	260	440	144	2050	3450	289	950	1250	98	4	4	298	
NU 252 M	260	480	80	1220	1800	148	1100	1400	67,10	5	5	320	
NJ 252 M	260	480	80	1220	1800	148	1050	1350	68,50	5	5	320	

Cylindrical Roller Bearing

DATA TABLE - SINGLE ROW



Part number	Principal dimensions			Basic load ratings			Speed limits		Weight	Radius		Dimensions	
	Bore	Outer	Height	Dynamic	Static	Fatigue	Grease	Oil		rs min	r1s min	F	E
	d	D	B	Cr	Cor	Pu	rpm		Kg	mm	mm	mm	
	mm			kN			1 min ⁻¹			mm		mm	
NUP 252 M	260	480	80	1220	1800	148	1050	1350	70	5	5	320	
NU 2252 M	260	480	130	1780	2910	240	1000	1300	107	5	5	320	
N 2252 M	260	480	130	1780	2910	240	950	1250	105	5	5		420
NJ 2252 M	260	480	130	1780	2910	240	950	1250	108	5	5	320	
NU 352 M	260	540	102	1880	2750	221	850	1050	126	6	6	337	
NU 2352 M	260	540	165	3150	4500	362	850	1050	188	6	6	319	
NJ 2856 M	280	350	42	363	790	68,3	1800	2200	9,15	2	2	299	
NU 1956 M	280	380	46	473	865	73,7	1700	1900	15,50	2,1	2,1	306	
NU 1056 M	280	420	65	704	1140	95,5	1400	1700	30,90	4	4	316	
NJ 1056 M	280	420	65	704	1140	95,5	1400	1700	32,20	4	4	316	
NU 2056 M	280	420	82	1190	2170	182	1050	1300	39,50	4	4	314	
NU 3156 M	280	460	146	2250	3900	321	900	1150	106	5	5	321	
NJ 256 M	280	500	80	1100	1750	142	1150	1450	71,50	5	5	340	
NU 256 M	280	500	80	1100	1750	142	1150	1450	70	5	5	340	
NU 2256 EM	280	500	130	2120	3721	302	1400	1700	122	5	5	340	
NU 356 M	280	580	108	1880	2660	209	850	1000	147	6	6	362	
NU 2356 M	280	580	175	2560	4250	335	900	1100	232	6	6	362	
NJ 2860 M	300	380	48	450	1000	84,5	1370	1650	14,60	2,1	2,1	321	
NU 2860 M	300	380	48	450	1000	84,5	1370	1650	14,50	2,1	2,1	321	
NJ 1060 M	300	460	74	935	1510	123	1200	1500	45,10	4	4	340	
NU 1060 M	300	460	74	935	1510	123	1200	1500	44,10	4	4	340	
NU 2060 M	300	460	95	1470	2800	229	980	1250	60	4	4	341	
NU 3060 M	300	460	118	1470	2700	221	1200	1500	72,50	4	4	340	
NU 260 M	300	540	85	1510	2270	180	1000	1300	86,90	5	5	364	
NU 2260 M	300	540	140	2080	3450	274	1000	1200	146	5	5	364	
NU 360 M	300	620	109	2310	3300	255	900	1100	166	7,5	7,5	385	
NU 2360 M	300	620	185	3860	5850	451	830	1000	271	7,5	7,5	371	
NU 1864 M	320	400	38	365	715	59,4	1270	1550	11,30	2,1	1,5	341	
NU 2864 M	320	400	48	490	1050	87,2	1250	1550	15	2,1	1,5	341	
NU 1964 M	320	440	56	638	1130	92,3	1100	1400	24,70	3	3	350	
NJ 1064 M	320	480	74	957	1580	127	1100	1400	47,80	4	4	360	
NU 1064 M	320	480	74	957	1580	127	1100	1400	48,20	4	4	360	
NUP 1064 M	320	480	74	957	1580	127	1100	1400	49,10	4	4	360	
NU 2064 M	320	480	95	1380	2650	213	970	1250	63	4	4	360	
NU 3064 M	320	480	121	1540	2910	234	1100	1400	78,10	4	4	360	
NU 3164 M	320	540	176	3050	5450	429	870	1050	176	5	5	368	

Cylindrical Roller Bearing

DATA TABLE - SINGLE ROW



Part number	Principal dimensions			Basic load ratings			Speed limits		Weight	Radius		Dimensions	
	Bore	Outer	Height	Dynamic	Static	Fatigue	Grease	Oil		rs min	r1s min	F	E
	d	D	B	Cr	Cor	Pu	rpm		Kg	mm		mm	
	mm			kN			1 min ⁻¹						
NU 264 M	320	580	92	1530	2450	190	960	1200	116	5	5	390	
NU 2264	320	580	150	2480	4150	322	900	1100	181	5	5	390	
NJ 2868 M	340	420	48	490	1150	94	1150	1450	15,50	2,1	2,1	361	
NU 1968 M	340	460	56	700	1400	113	1050	1350	28,30	3	3	370	
NU 2968 M	340	460	72	785	1650	133	1050	1350	36,20	3	3	373	
NU 1068 M	340	520	82	1160	1910	150	1000	1300	65	5	5	385	
NU 2268 M	340	620	165	2600	4550	347	810	950	225	6	6	416,	
NU 1072 M	360	540	82	1080	2000	155	980	1280	65,90	5	5	405	
NU 2072 M	360	540	106	1890	3560	276	870	1050	89,50	5	5	405	
NU 3072 M	360	540	134	2060	4050	315	800	1000	112	5	5	405	
NU 3172	360	600	192	3520	6500	495	900	1000	219	5	5	420	
NU 2272 M	360	650	170	3150	5400	405	800	950	262	6	6	437	
NU 2372	360	750	224	5390	8650	631	700	850	480	7,5	7,5	455	
NU 1876 M	380	480	46	525	1050	82,7	950	1250	23,50	2,1	2,1	406	
NUP 1876 M	380	480	46	525	1050	82,7	950	1250	20,30	2,1	2,1	406	
NU 1076 M	380	560	82	1240	2100	161	950	1200	71	5	5	425	
NU 2076 EM	380	560	106	1930	3750	287	800	950	93	5	5	425	
NU 3076 EM	380	560	135	2250	4700	360	800	950	116	5	5	425	
NU 2276 EM	380	680	175	3050	5500	407	730	860	276	6	6	462	
NU 1880 M	400	500	46	565	1150	89,3	980	1250	21,20	2,1	2,1	423	
NU 1980 M	400	540	65	900	1750	134	900	1150	42	4	4	435	
NU 2980 EM	400	540	82	1350	2850	218	900	1150	57,80	4	4	435	
NU 2980 M	400	540	82	1250	2510	192	900	1150	55,20	4	4	438	
NJ 4980 M	400	540	140	5170	2220	170	1200	1500	84	3	3		
NUP 1080 M	400	600	90	1330	2210	166	900	1100	93,60	5	5	450	
NU 1080 M	400	600	90	1330	2210	166	900	1100	92,50	5	5	450	
NJ 1080	400	600	90	1440	2470	186	900	1100	90,60	5	5	450	
NU 2080 EM	400	600	118	2150	4800	361	750	900	122	5	5	449	
NU 3080 M	400	600	148	2330	4550	342	900	1100	153	5	5	450	
NU 2180 M	400	650	145	2920	5190	385	700	850	197	6	6	460	
NU 3180 M	400	650	200	3760	7170	532	700	850	274	6	6	460	
NU 2280 M	400	720	185	4300	7800	567	800	1050	344	6	6	485	
NU 1884	420	520	46	605	1270	97,4	900	1100	20,70	2,1	2,1	447	
NJ 3884 M	420	520	75	900	2250	172	930	1150	33,30	2,1	2,1	447	
NJ 1984 M	420	560	65	1080	1950	148	930	1150	46	4	4	449	
NU 2984 M	420	560	82	1180	2600	197	930	1150	59,50	4	4	458	

Cylindrical Roller Bearing

DATA TABLE - SINGLE ROW



Part number	Principal dimensions			Basic load ratings			Speed limits		Weight	Radius		Dimensions	
	Bore	Outer	Height	Dynamic	Static	Fatigue	Grease	Oil		rs min	r1s min	F	E
	d	D	B	Cr	Cor	Pu	rpm		Kg	mm		mm	
	mm			kN			1 min ⁻¹						
NU 1084 M	420	620	90	1440	2490	185	900	1100	98	5	5	470	
NU 2084 EM	420	620	118	2400	4750	353	770	950	127	5	5	469	
NU 3184 EM	420	700	224	4950	8950	651	650	780	368	6	6	485	
NU 2888 EM	440	540	60	790	1900	144	870	1050	34,50	2,1	2,1	464	
NU 1988 M	440	600	74	1010	1980	147	870	1050	65	4	4	482	
NJ 2988 EM	440	600	95	1670	3550	264	870	1050	83,50	4	4	481,5	
NUP 3988 EM	440	600	118	1940	4250	316	850	1000	106	4	4	481,5	
NU 1088 M	440	650	94	1570	2430	178	850	1000	102	6	6	493	
NU 2088 EM	440	650	122	2450	5000	367	670	820	146	6	6	487	
N 1188	440	720	122	2850	4300	309	800	950	207	6	6		648
NU 3188	440	720	226	5230	9800	705	600	750	374	6	6	508	
N 1892 M	460	580	56	795	1720	128	800	950	37,20	3	3		553
NJ 2892 EM	460	580	72	1030	2350	175	860	1050	48,70	3	3	489	
NJ 2992	460	620	95	1640	3500	257	800	950	83,40	4	4	502	
NUP 2992	460	620	95	1670	1600	118	800	950	85	4	4	502	
NU 2992	460	620	95	1670	1600	118	800	950	98,30	4	4	502	
NU 1092 M	460	680	100	1690	2630	190	800	950	111	6	6	516	
NU 2092 EM	460	680	128	2700	5450	394	650	800	166	6	6	513	
NU 3092 M	460	680	163	2970	6150	445	650	790	211	6	6	516	
NU 3092 EM	460	680	163	3300	6340	459	650	790	211	6	6	499	
NU 3192	460	760	240	5450	10400	737	400	480	467	7,5	7,5	531	
NU 3192 M	460	760	240	5450	10400	737	400	480	481	7,5	7,5	531	
NU 2292 M	460	830	212	4850	8000	558	580	670	5150	7,5	7,5	554	
NU 1896 M	480	600	56	750	1620	119	840	950	37,50	3	3	511	
NJ 2896 EM	480	600	72	1050	2400	176	840	950	46,50	3	3	509,5	
NU 1096 M	480	700	100	1600	2970	213	720	860	128	6	6	536	
NU 2096 M	480	700	128	2600	5250	376	600	720	176	6	6	536	
NU 3196 EM	480	790	248	5650	10700	749	500	600	4950	7,5	7,5	547	
NU 28/500 EM	500	620	72	1130	2670	194	780	940	48,50	3	3	530	
NU 19/500 EM	500	670	78	1160	2350	169	720	880	80	5	5	544	
NU 29/500	500	670	100	1940	4300	309	750	900	101	5	5	543	
N 39/500 EM	500	670	128	2250	5150	370	670	840	128	5	5		633
NJ 10/500	500	720	100	1680	3050	216	720	880	136	6	6	556	
NU 60/500 M	500	720	100	2270	4270	303	750	900	136,90	6	6	555	
NU 20/500 EM	500	720	128	2850	5900	418	620	720	175	6	6	553	
NU 30/500	500	720	167	3210	6970	494	620	720	232	6	6	556,0	

Cylindrical Roller Bearing

DATA TABLE - SINGLE ROW



Part number	Principal dimensions			Basic load ratings			Speed limits		Weight	Radius		Dimensions	
	Bore	Outer	Height	Dynamic	Static	Fatigue	Grease	Oil		rs min	r1s min	F	E
	d	D	B	Cr	Cor	Pu	rpm		Kg	mm		mm	
NU 31/500	500	830	264	6250	12200	843	480	580		602	7,5	7,5	581
NU 12/500 M	500	920	185	5050	8450	572	540	650	585	7,5	7,5	603,1	
NJ 19/530 EM	530	710	82	1500	2980	210	680	830	94,50	5	5	573	
NUP 29/530	530	710	106	1990	4550	321	400	500	125	5	5	580	
NU 10/530 M	530	780	112	2200	4050	281	650	780	187	6	6	593	
NU 20/530 EM	530	780	145	3650	7360	511	550	650	252	6	6	591	
NU 31/530 EM	530	870	272	7250	14500	986	460	550	663	7,5	7,5	612	
NJ 18/560 M	560	680	56	810	1830	129	670	820	42,50	3	3	591	
NU 19/560 EM	560	750	85	1630	3200	222	650	780	108	5	5	608	
NJ 29/560	560	750	112	2420	5450	378	650	780	148	5	5	607	
N 29/560	560	750	112	2490	5600	389	650	780	138	5	5		703
NU 10/560 M	560	820	115	2250	4200	287	620	720	215	6	6	625	
NU 20/560 EM	560	820	150	3650	7600	519	500	600	289	6	6	626	
NU 12/560 M	560	1030	206	6850	11000	720	460	550	809	9,5	9,5	668	
NU 18/600 EM	600	730	60	860	2000	138	650	780	49,30	3	3	632	
NU 28/600 EM	600	730	78	1250	3350	231	620	730	68,50	3	3	632	
NU 19/600 EM	600	800	90	1900	3800	258	620	750	128	5	5	649	
NUP 19/600 EM	600	800	90	1900	3800	258	620	750	135	5	5	649	
NUP 19/600 M	600	800	90	1900	3800	258	630	750	135	5	5	649	
NUP 29/600 M	600	800	118	2920	6550	446	630	750	145	5	5	649	
NU 10/600	600	870	118	2840	5250	352	590	680	234	6	6	667	
NU 20/600 EM	600	870	155	4180	8000	536	500	600	320	6	6	661	
NJ 18/630 EM	630	780	69	1050	2500	170	630	750	74,20	4	4	667	
N 28/630 M	630	780	88	1800	4500	305	630	750	95,60	4	4		744
NU 28/630 M	630	780	88	1800	4500	305	630	750	96	4	4	668	
N 38/630 M	630	780	112	2150	5750	390	550	650	118	4	4		745
NU 19/630 M	630	850	100	1980	4000	268	600	700	158	6	6	688	
NU 19/630 EM	630	850	100	2150	4250	284	600	700	160	6	6	683	
NU 29/630 EM	630	850	128	3250	7250	485	580	680	214	6	6	683	
NJ 29/630 EM	630	850	128	3250	7250	485	580	680	222	6	6	683	
NU 10/630 EM	630	920	128	3400	6250	412	450	530	284	7,5	7,5	702	
NUP 10/630 EM	630	920	128	3400	6250	412	450	530	284	7,5	7,5	702	
NU 20/630 EM	630	920	170	4700	9500	627	480	560	395	7,5	7,5	699	
NU 30/630	630	920	212	6450	14500	957	450	530	485	7,5	7,5	699	
NJ 18/670	670	820	69	1230	2800	187	550	650	83,80	4	4	708	
NUP 19/670	670	900	103	2420	4900	322	530	630	193	6	6	731	

Cylindrical Roller Bearing

DATA TABLE - SINGLE ROW



Part number	Principal dimensions			Basic load ratings			Speed limits		Weight	Radius		Dimensions	
	Bore	Outer	Height	Dynamic	Static	Fatigue	Grease	Oil		rs min	r1s min	F	E
	d	D	B	Cr	Cor	Pu	rpm		Kg	mm	mm	mm	
	mm			kN			1 min ⁻¹			mm		mm	
NU 19/670	670	900	103	2420	4900	322	530	630	193	6	6	731	
NU 10/670	670	980	136	3700	6800	440	430	500	344	7,5	7,5	747	
N 30/670	670	980	230	6930	15000	971	430	500	594	7,5	7,5		914
NU 30/670 M	670	980	230	6500	14500	939	430	500	596	7,5	7,5	744	
NU 6/700	700	930	160	3520	8500	552	500	600	306	6	6	760	
NUP 6/700	700	930	160	3520	8500	552	500	600	316	6	6	760	
N 28/710 EM	710	870	95	1880	4950	325	480	560	128	4	4		831
NU 19/710	710	950	106	2590	5500	355	480	560	210	6	6	770	
NU 29/710 EM	710	950	140	3650	8250	533	480	560	294	6	6	766	
NU 10/710 EM	710	1030	140	4550	8400	535	420	490	420	7,5	7,5	778	
NU 20/710 EM	710	1030	185	5800	12000	765	480	560	535	7,5	7,5	787	
NU 18/750 M	750	920	78	1450	3500	226	480	590	105	5	5	794	
N 28/750	750	920	100	2160	5500	355	480	590	145	5	5		880
NU 10/750 EM	750	1090	150	4500	8500	533	350	415	492	7,5	7,5	830	
NU 20/750 EM	750	1090	195	6700	14500	909	350	415	634	7,5	7,5	832	
NJ 18/800 EM	800	980	82	1700	4200	266	430	510	144	5	5	846	
NU 10/800 EM	800	1150	155	5400	10500	647	320	380	565	7,5	7,5	883	
NU 20/800 EM	800	1150	200	6900	14500	893	320	380	710	7,5	7,5	882	
N 6/820	820	990	72	1180	2960	186	450	530	128	5	5		943
NU 28/850 M	850	1030	106	2050	5900	367	410	480	192	5	5	902	
NU 19/850 EM	850	1120	118	3050	6900	424	390	460	325	6	6	919	
NJ 19/850	850	1120	118	2930	7000	430	390	460	326	6	6	919	
N 29/850 EM	850	1120	155	4500	11300	694	390	460	428	6	6		1059
NU 18/900 M	900	1090	85	1900	4850	297	370	440	172	5	5	949	
NU 28/900 M	900	1090	112	2650	7150	438	370	440	234	5	5	949	
NU 19/900 EM	900	1180	122	4050	8700	526	350	420	378	6	6	966,5	
NU 29/900 EM	900	1180	165	5750	13500	815	350	420	565	6	6	969	
NU 29/950	950	1250	175	5560	13000	772	340	400	596	7,5	7,5	1024	
NUP 29/950	950	1250	175	5670	13400	796	140	170	616	7,5	7,5	1024	
NU 18/1000 M	1000	1220	100	2650	6550	388	350	420	264	6	6	1053	
NJ 28/1000 EM	1000	1220	128	3600	9500	563	350	420	345	6	6	1053	
N 28/1060 M	1060	1280	128	3550	10500	612	310	370	355	6	6		1225
NU 29/1060 EM	1060	1400	195	7200	17000	976	290	350	875	7,5	7,5	1146	
NU 39/1060 EM	1060	1400	250	9000	23500	1350	250	310	1060	7,5	7,5	1146	
N 30/1060	1060	1500	325	12500	32500	1845	230	290	1880	9,5	9,5		1390
NJ 18/1120 EM	1120	1360	106	3350	8600	493	270	330	330	6	6	1182	

Cylindrical Roller Bearing

DATA TABLE - SINGLE ROW



Part number	Principal dimensions			Basic load ratings			Speed limits		Weight	Radius		Dimensions	
	Bore	Outer	Height	Dynamic	Static	Fatigue	Grease	Oil		rs min	r1s min	F	E
	d	D	B	Cr	Cor	Pu	rpm		Kg	mm		mm	
mm			kN			1 min ⁻¹							
NJ 18/1180 EM	1180	1420	106	2950	7750	438	250	320	354	6	6	1242	
NU 29/1180 M	1180	1540	206	8950	21500	1198	180	220	1100	7,5	7,5	1258	
N 39/1180 M	1180	1540	272	11000	28500	1588	190	250	1350	7,5	7,5		1466
N 20/1250 M	1250	1750	290	12500	29500	1597	165	190	2310	9,5	9,5		1635
NU 18/1320 M	1320	1600	122	3650	9500	518	190	250	525	6	6	1395	
NU 19/1320	1320	1720	175	7920	19500	1051	190	240	1110	7,5	7,5	1425	
N 39/1320 M	1320	1720	300	12600	32500	1752	175	210	1890	7,5	7,5		1640
N 28/1400 EM	1400	1700	175	6300	1750	93,8	175	210	858	7,5	7,5		1637
NU 18/1700 EM	1700	2060	160	6950	18500	936	125	155	1156	7,5	7,5	1784	
N 18/1900	1900	2300	175	8150	23700	1159	90	115	1480	9,5	9,5		2204

TECHNICAL NOTEBOOK

ROLLWAY®

CYLINDRICAL ROLLER BEARING

DOUBLE ROW



In this section:

	Page
Design Characteristics Applications Angular Misalignment	
ISO Specification	98
Series Nomenclature Equivalent Load Equations Lubrication	99
Radial Clearance Tables.....	100
Data Tables	101-102

REGAL®

Cylindrical Roller Bearing

DOUBLE ROW

DESIGN | CHARACTERISTICS | APPLICATIONS

Double and multi-row bearings are also manufactured in see NN and NNU series.

These series are used in applications where the radial load are very high, a high running accuracy is required combined with a high radial rigidity. Typical applications are steel and paper mills.

Beside the ISO bearings a lot of non ISO bearings are available. Contact Regal for more info.



NN30



NN30 K



NNU49



NNU49 K

ANGULAR MISALIGNMENT

The following is an approximate guide to the misalignment that can be accommodated in a cylindrical roller bearing:

0.0001 radians

Greater misalignment under heavy radial load can be critical.

ISO SPECIFICATIONS

- Dimensions in accordance with ISO 15 (latest version)
- Precision class in accordance with ISO 492 (latest version)
- Radial clearance in accordance with ISO 5753 (latest version)

SERIES

Only the underlined series are popular. All series are available in the for designs.



NN 3000



NNU 4900

NOMENCLATURE

Prefixes:

R : Bearing without outer ring

Suffixes:

M : Brass cage guided on the rollers

NA : Non-interchangeable rings

C1 - C5 : Radial clearance class

P0 - P4 : Precision class

P63 : Precision class P6 + Radial clearance class C3

(Precision class P6 + Radial clearance class C3)

EQUIVALENT LOAD EQUATIONS

Equivalent dynamic load P_e

The equivalent load equations are the same for the double row and single row cylindrical roller bearings. Refer to pages 63-65.

LUBRICATION

Refer to the lubrication chapter (pages 340-344) to have more info about the lubrication of cylindrical roller bearings.

Cylindrical Roller Bearing

DOUBLE ROW

RADIAL CLEARANCE TABLES

For cylindrical bore with Non-Interchangeable rings



Bore diameter		Clearance group symbol											
d		C1		C2		CN		C3		C4		C5	
mm		µm		µm		µm		µm		µm		µm	
over	up to	min.	max.	min.	max.	min.	max.	min.	max.	min.	max.	min.	max.
2,5	6	0	7	8	15	15	25	30	40	40	50		
6	10	0	7	10	20	20	30	35	45	45	55		
10	14	0	10	10	20	20	30	35	45	45	55		
14	24	5	15	10	20	20	30	35	45	45	55	65	75
24	20	5	15	10	25	25	35	40	50	50	60	70	80
30	40	5	15	12	25	25	40	45	55	55	70	80	95
40	50	5	18	15	30	30	45	50	65	65	80	95	110
50	65	5	20	15	35	35	50	55	75	75	90	110	130
65	80	10	25	20	40	40	60	70	90	90	110	130	150
80	100	10	30	25	45	45	70	80	105	105	125	155	180
100	120	10	30	25	50	50	80	95	120	120	145	180	205
120	140	10	35	30	60	60	90	105	135	135	160	200	230
140	160	10	35	35	65	65	100	115	150	150	180	225	260
160	180	10	40	35	75	75	110	125	165	165	200	250	285
180	200	15	45	40	80	80	120	140	180	180	220	275	315
200	225	15	50	45	90	90	135	155	200	200	240	305	350
225	250	15	50	50	100	100	150	170	215	215	265	330	380
250	280	20	55	55	110	110	165	185	240	240	295	370	420
280	315	20	60	60	120	120	180	205	265	265	325	410	470
315	355	20	65	65	135	135	200	225	295	295	360	455	520
355	400	25	75	75	150	150	225	255	330	330	405	510	585
400	450	25	85	85	170	170	255	285	370	370	455	565	650
450	500	25	95	95	190	190	285	315	410	410	505	625	720
500	560	25	100	105	210	210	315	350	455	455	560	720	815
560	630	30	110	115	230	230	345	390	505	505	620	800	910
630	710	30	130	130	260	260	390	435	565	565	695	900	1030
710	800	35	140	145	290	290	435	485	630	630	775	1000	1140
800	900	35	160	160	320	320	480	540	700	700	860	1130	1290
900	1000	35	180	180	360	360	540	600	780	780	960	1270	1440
1000	1120	50	200	200	400	400	600	660	880	880	1060	1380	1560
1120	1250	60	220	220	440	440	660	730	950	950	1170	1520	1720
1250	1400	60	240	240	480	480	720	810	1050	1050	1290	1680	1900
1400	1600	70	270	270	540	540	810	910	1190	1190	1460	1900	2150

For tapered bore

Radial clearance for bearings with tapered bore is selected in the above table from one group to the right, for example radial clearance CN for cylindrical bore bearings match C3 for tapered bore bearings.

Note

For the radial clearance for Interchangeable rings refer to the chapter Single row cylindrical roller bearing (page 66).

Cylindrical Roller Bearing

DATA TABLE - DOUBLE ROW

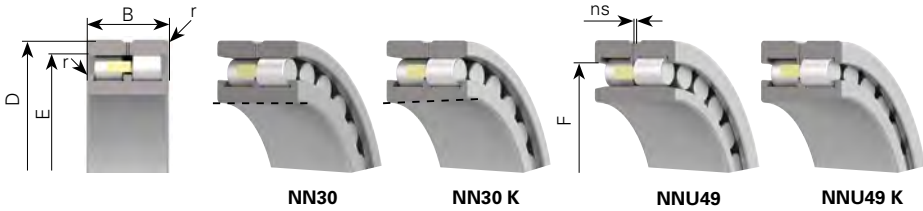

Part number	Principal dimensions			Basic load ratings			Speed limits		Weight	Radius		Dimensions	
	Bore	Outer	Width	Dynamic	Static	Fatigue	Grease	Oil		r min	ns	F	E
	d	D	B	Cr	Cor	Pu	rpm	1 min ⁻¹	Kg	mm	mm	mm	mm
NN 3006 K M NA	30	55	19	29,0	38	4,63	11000	14000	0,192	1,0	4,5		48,5
NN 3007 K M NA	35	62	20	36,5	47	5,73	10000	12000	0,246	1,0	4,5		55
NN 3008 K M NA	40	68	21	42,5	58	7,07	9000	11000	0,298	1,0	4,5		61
NN 3009 K M NA	45	75	23	48,5	70	8,54	8000	9500	0,382	1,0	4,5		67,5
NN 3010 K M NA	50	80	23	51,5	80	9,76	7500	9000	0,415	1,0	4,5		72,5
NN 3011 K M NA	55	90	26	69,0	100	12,2	6700	8000	0,618	1,1	4,5		81
NN 3012 K M NA	60	95	26	72,0	110	13,4	6300	7500	0,664	1,1	4,5		86,1
NN 3013 K M NA	65	100	26	74,0	118	14,4	6000	7000	0,705	1,1	4,5		91
NN 3014 K M NA	70	110	30	96,0	151	18,4	5300	6300	1,020	1,1	6,5		100
NN 3015 K M NA	75	115	30	96,0	153	18,7	5000	6000	1,080	1,1	6,5		105
NN 3016 K M NA	80	125	34	118,0	184	22,3	4800	5600	1,500	1,1	6,5		113
NN 3017 K M NA	85	130	34	122,0	200	23,9	4500	5300	1,580	1,1	6,5		118
NN 3018 K M NA	90	140	37	141,0	224	26,2	4300	5000	2,010	1,5	6,5		127
NN 3019 K M NA	95	145	37	146,0	236	27,2	4000	4800	2,100	1,5	6,5		132
NNU 4920 M NA	100	140	40	125,0	244	28,2	4000	4800	1,790	1,1	6,5	113	
NNU 4920 K M NA	100	140	40	125,0	244	28,2	4000	4800	1,800	2,0	6,5	113	
NN 3020 K M NA	100	150	37	152,0	264	30,1	3800	4500	2,210	1,5	6,5		137
NNU 4921 K M NA	105	145	40	118,0	231	26,3	3800	4500	2,000	1,1	6,5	118	
NN 3021 K M NA	105	160	41	192,0	310	34,7	3600	4300	2,810	2,0	6,5		146
NNU 4922 K M NA	110	150	40	129,0	264	29,8	3800	4500	1,910	1,1	6,5	123	
NN 3022 K M NA	110	170	45	226,0	365	40,2	3400	4000	3,560	2,0	6,5		155
NNU 4924 K M NA	120	165	45	170,0	328	36,0	3400	4000	2,660	1,1	6,5	134	
NN 3024 K M NA	120	180	46	235,0	405	43,7	3200	3800	3,870	2,0	6,5		165
NNU 4926 K M NA	130	180	50	193,0	371	39,7	3200	3800	3,600	1,5	6,5	146	
NN 3026 K M NA	130	200	52	294,0	510	53,5	3000	3600	5,760	2,0	9,5		182
NNU 4928 K M NA	140	190	50	189,0	395	41,5	3000	3600	3,790	1,5	6,5	156	
NN 3028 K M NA	140	210	53	305,0	520	53,6	2800	3400	6,210	2,0	9,5		192
NNU 4930 K M NA	150	210	60	326,0	645	65,9	2600	3200	6,460	2,0	9,5	168,5	
NN 3030 K M NA	150	225	56	339,0	600	60,6	2600	3000	7,500	2,1	9,5		206
NNU 4932 K M NA	160	220	60	322,0	652	65,6	2600	3000	6,380	2,0		178	
NNU 4934 K M NA	170	230	60	335,0	718	71,1	2400	3000	7,210	2,0	6,5	188,5	
NN 3034 K M NA	170	260	67	458,0	810	78,5	2200	2600	12,400	2,1	9,5		236
NN 3036 K M NA	180	280	74	576,0	1080	103	2000	2600	16,300	2,1	12,2		255
NNU 4944 M NA	220	300	82	533,7	1330	122	1800	2100	16,600	2,1		243	
NN 3048 K	240	360	92	885,0	1690	148	1700	2000	32,700	3,0			330

Cylindrical Roller Bearing

DATA TABLE - DOUBLE ROW

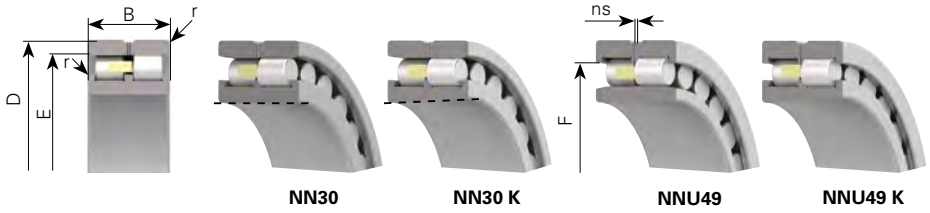

Part number	Principal dimensions			Basic load ratings			Speed limits		Weight	Radius		Dimensions	
	Bore	Outer	Width	Dynamic	Static	Fatigue	Grease	Oil		r min	ns	F	E
	d	D	B	Cr	Cor	Pu	rpm		mm				
	mm			kN			1 min ⁻¹		Kg				
NNU 4952 M NA	260	360	100	852,8	2100	182	1600	1900	31,70	2,1		292	
NN 3056 K M NA	280	420	106	1110	1985	166	1400	1700	49,50	4,0	15,0		384
NNU 4960 K M NA	300	420	118	1075	2410	200	1300	1600	50,50	3,0			339
NNU 4964 K M NA	320	440	118	1115	2581	211	1300	1500	54,50	3,0			359
NNU 4164 M	320	540	218	3300	6200	488	700	1000	200	5,0			375
NNU 4972 M	360	480	118	1120	2800	222	1120	1400	55	3,0	3,0		399
NNU 4172 M	360	600	243	3900	8500	647	900	1100	275	3,0			
NNU 4976 K M NA	380	520	140	1485	3760	292	1100	1300	91	4,0			426
NN 3076 K M NA	380	560	135	1640	3650	280	1000	1200	111	5,0	16,7		513
NNU 4984 M	420	560	140	1550	4081	309	1000	1000	96	4,0	16,7		466
NNU 4188 M	440	720	280	4470	11500	828	600	700	452	6,0			511
NNU 4992 K M NA	460	620	160	2135	5543	408	900	1100	143	4,0			510
NNU 49/500 K M NA	500	670	170	2715	6920	497	800	1000	178	5,0			552
NNU 41/500 M	500	830	325	7400	14500	1002	580	700	705	7,5			582
NNU 49/530 K M NA	530	710	180	3140	8845	624	800	950	218	5,0			588
NNU 49/630 K M NA	630	850	218	3835	10716	717	670	800	368	6,0			704
NNU 41/630 M NA	630	1030	400	10263	22104	1429	340	420	1304	7,5			734

TECHNICAL NOTEBOOK

ROLLWAY®

FULL COMPLEMENT
CYLINDRICAL ROLLER BEARING
SINGLE ROW



In this section:	Page
Design Characteristics Applications Angular Misalignment	
ISO Specification	104
Series Nomenclature Equivalent Load Equations	
Lubrication Radial Clearance Tables	105
Data Tables	106-110

REGAL®

Cylindrical Roller Bearing

FULL COMPLEMENT - SINGLE ROW

DESIGN | CHARACTERISTICS | APPLICATIONS

The cylindrical rollers of these bearings are operating without cage. The NCF design has 2 shoulder on the inner ring and 1 shoulder on the outer ring. To keep the bearing assemble, a snap ring is used on the outer ring. The NJG design is similar to the NJ design.

The lack of a cage allows to assemble more rollers inside the bearing, thus the radial loads are higher compared with the version with cage.

Without cage, the rollers are rotating in opposite direction against each other which results in higher internal friction. The speed limits are thus lower compared with the cylindrical bearing with cage.

Typical application are satellite gears in planetary gearboxes. Often, we supply these bearings without outer ring. The gear bore is than the raceway.

There are 2 designs: NCF, NJG.



NCF

NJGV

ANGULAR MISALIGNMENT

The following is an approximate guide to the misalignment that can be accommodated in a cylindrical roller bearing:

0.0004 radians

Greater misalignment under heavy radial load can be critical.

ISO SPECIFICATIONS

- Dimensions in accordance with ISO 15 (latest version)
- Precision class in accordance with ISO 492 (latest version)
- Radial clearance in accordance with ISO 5753 (latest version)

SERIES



NCF 1800

NCF 2800

NCF 2900 CV

NCF 3000 CV

NCF 2200 CV

NOMENCLATURE

Prefixes:

R : Bearing without outer ring

Suffixes:

C2 - C5 : Radial clearance class

P0 - P4 : Precision class

V : No cage

CV : No cage combined with internal geometry optimization

EQUIVALENT LOAD EQUATIONS

Refer to the chapter single row cylindrical roller bearing (page 63-65).

LUBRICATION

Refer to the lubrication chapter (pages 340-344) to have more info about the lubrication of cylindrical roller bearings.

RADIAL CLEARANCETABLES

Refer to the chapter single row cylindrical roller bearing (page 66).

Cylindrical Roller Bearing

DATA TABLE - FULL COMPLEMENT / SINGLE ROW



NCF

NJGV

Part number	Principal dimensions			Basic load ratings			Speed limits		Weight	Radius	Dimensions		ALT. CODE
	Bore	Outer	Width	Dynamic	Static	Fatigue	Grease	Oil			rs min	E & F	
	d	D	B	Cr	Cor	Pu	rpm		Kg	mm	mm		
	mm			kN			1 min ⁻¹						
NCF 3004 CV	20	42	16	27,5	26,5	3,23	9000	10500	0,11	0,6	36,8	1,5	SL18 3004
NCF 2204 CV	20	47	18	41	37,5	4,57	8000	9500	0,16	1	41,5	1	SL18 2204
NCF 3005 CV	25	47	16	31,5	32,5	3,96	7000	9000	0,12	0,6	42,5	1,5	SL18 3005
NCF 2205 CV	25	52	18	46	45	5,49	6500	8500	0,18	1	46,5	1	SL18 2205
NJG 2305 CV	25	62	24	65	60	7,32	5500	7500	0,37	1,1	37,1	2	SL19 2305
NCF 3006 CV	30	55	19	40,5	43	5,24	6500	7500	0,20	1	49,6	2	SL18 3006
NCF 2206 CV	30	62	20	63	65	7,93	5500	7000	0,30	1	55,2	1	SL18 2206
NJG 2306 CV	30	72	27	89	88	10,7	4900	6500	0,56	1,1	38,3	2	SL19 2306
NCF 3007 CV	35	62	20	49,5	55	6,71	6000	6500	0,26	1	55,5	2	SL18 3007
NCF 2207 CV	35	72	23	79	79	9,63	5000	6000	0,44	1,1	64,0	1	SL18 2207
NCF 2307 CV	35	80	31	113	112	13,7	4300	5500	0,74	1,5	44,68	2	SL18 2307
NJG 2307 CV	35	80	31	113	112	13,7	4300	5500	0,74	1,5	44,68	2	SL19 2307
NCF 3008 CV	40	68	21	59	68	8,29	5000	6000	0,31	1	61,7	2	SL18 3008
NCF 2208 CV	40	80	23	87	83	10,1	4400	5500	0,55	1,1	70,9	1	SL18 2208
NJG 2308 CV	40	90	33	152	156	19	3600	5000	1	1,5	51,1	2	SL19 2308
NCF 3009 CV	45	75	23	63	76	9,27	5000	5500	0,4	1	66,9	2	SL18 3009
NCF 2209 CV	45	85	23	90	99	12,1	4200	5000	0,59	1,1	74,4	1	SL18 2209
NJG 2309 CV	45	100	36	162	172	21	3700	4500	1,37	1,5	56,1	3	SL19 2309
NCF 3010 CV	50	80	23	79	96	11,7	4500	5000	0,43	1	72,3	2	SL18 3010
NCF 2210 CV	50	90	23	97	113	13,8	3600	4600	0,64	1,1	81,4	1	SL18 2210
NJG 2310 CV	50	110	40	208	219	26,7	3400	4100	1,81	2	60,7	3	SL19 2310
NCF 2211 CV	55	100	25	125	150	18,3	3300	4200	0,87	1,5	88,8	1,5	SL18 2211
NCF 3011 CV	55	90	26	107	138	16,8	3800	4500	0,64	1,1	83,5	2	SL18 3011
NJG 2311 CV	55	120	43	242	255	31,1	3100	3700	2,28	3	67,1	3	SL19 2311
NCF 2912 CV	60	85	16	57	78	9,51	3500	4500	0,29	1	78,6	1	SL18 2912
NCF 3012 CV	60	95	26	110	145	17,7	3600	4200	0,69	1,1	86,7	2	SL18 3012
NCF 2212 CV	60	110	28	152	180	22	3100	3800	1,18	1,5	99,2	1,5	SL18 2212
NJG 2312 CV	60	130	46	260	280	34,1	2900	3400	2,88	2,1	73,6	3	SL19 2312
NCF 2913 CV	65	90	16	60	86	10,5	3100	4200	0,31	1	85,2	1	SL18 2913
NCF 3013 CV	65	100	26	116	159	19,4	3300	3900	0,73	1,1	93,1	2	SL18 3013
NCF 2213 CV	65	120	31	178	214	26,1	3000	3500	1,57	1,5	106,3	1,5	SL18 2213
NJG 2313 CV	65	140	48	315	355	43	2500	3200	3,52	2,1	80,7	3,5	SL19 2313
NCF 2914 CV	70	100	19	79	114	13,9	3100	3800	0,49	1	92,3	1	SL18 2914
NCF 3014 CV	70	110	30	137	176	21,5	3400	3600	1	1,1	100,3	3	SL18 3014
NCF 2214 CV	70	125	31	184	227	27,7	2800	3300	1,66	1,5	111,5	1,5	SL18 2214

S*: indicates maximum axial displacement from the inner ring.

Cylindrical Roller Bearing

DATA TABLE - FULL COMPLEMENT / SINGLE ROW



Part number	Principal dimensions			Basic load ratings			Speed limits		Weight	Radius	Dimensions		ALT. CODE
	Bore	Outer	Width	Dynamic	Static	Fatigue	Grease	Oil			rs min	E & F	
	d	D	B	Cr	Cor	Pu	rpm		Kg	mm			
	mm			kN			1 min ⁻¹						
NJG 2314 CV	70	150	51	345	390	46,2	2400	2900	4,33	2,1	84,1	3,5	SL19 2314
NCF 2915 CV	75	105	19	81	121	14,8	2900	3600	0,52	1	97,4	1	SL18 2915
NCF 3015 CV	75	115	30	145	194	23,7	3000	3400	1,06	1,1	107,9	3	SL18 3015
NCF 2215 CV	75	130	31	190	241	29,2	2700	3200	1,75	1,5	116,2	1,5	SL18 2215
NCF 2916 CV	80	110	19	84	129	15,7	2700	3400	0,55	1	102,5	1	SL18 2916
NCF 2216 CV	80	140	33	226	285	33,8	2500	2900	2,15	2	126,3	1,5	SL18 2216
NCF 3016 CV	80	125	34	173	225	27,2	3000	3200	1,43	1,1	117,4	4	SL18 3016
NJG 2316 CV	80	170	58	480	560	63,9	1900	2600	6,32	2,1	98,2	3,5	SL19 2316
NCF 2917 CV	85	120	22	105	162	19,6	2700	3200	0,81	1,1	109,6	1	SL18 2917
NCF 3017 CV	85	130	34	178	237	28,3	2800	3000	1,51	1,1	122	4	SL18 3017
NCF 2217 CV	85	150	36	255	325	37,8	2400	2800	2,74	2	133,8	1,5	SL18 2217
NJG 2317 CV	85	180	60	510	620	69,5	1700	2400	7,34	3	107	4	SL19 2317
NCF 2918 CV	90	125	22	109	172	20,5	2500	3000	0,84	1,1	115,8	1	SL18 2918
NCF 3018 CV	90	140	37	208	280	32,7	2700	2800	1,97	1,5	130,6	4	SL18 3018
NCF 2218 CV	90	160	40	290	370	42,2	2100	2600	3,48	2	141,2	2,5	SL18 2218
NJG 2318 CV	90	190	64	560	660	72,8	1800	2300	8,83	3	105,3	4	SL19 2318
NCF 2919 CV	95	130	22	118	179	21,1	2400	2900	0,86	1,1	122,3	1	SL18 2919
NCF 2219 CV	95	170	43	340	435	48,8	2000	2400	4,17	2,1	156	2,5	SL18 2219
NJG 2319 CV	95	200	67	580	720	78,1	1700	2200	10,2	3	114,7	4	SL19 2319
NCF 2920 CV	100	140	24	136	206	23,8	2300	2700	1,14	1,1	131	1,5	SL19 2319
NCF 3020 CV	100	150	37	219	310	35,4	1800	2100	2,15	1,5	139	4	SL18 3020
NCF 2220 CV	100	180	46	395	520	57,3	1500	2500	5,13	2,1	163,4	2,5	SL18 2220
NJG 2320 CV	100	215	73	710	860	91,5	2100	2300	13	3	119,3	4	SL19 2320
NCF 2922 CV	110	150	24	140	220	24,8	2100	2200	1,23	1,1	141,5	1,5	SL18 2922
NCF 3022 CV	110	170	45	285	395	43,5	1800	1900	3,50	2	156,7	5,5	SL18 3022
NCF 2222 CV	110	200	53	455	590	63,1	1300	2300	7,24	2,1	177,6	4	SL18 2222
NJG 2322 CV	110	240	80	850	980	101	1900	2200	17	3	134,3	5	SL19 2322
NCF 2924 CV	120	165	27	180	295	32,3	1700	1900	1,73	1,1	154,3	1,5	SL18 2924
NCF 3024 CV	120	180	46	300	435	47,0	1200	2000	3,80	2	167,5	5,5	SL18 3024
NCF 2224 CV	120	215	58	540	730	76,3	1500	1800	9,08	2,1	192,9	4	SL18 2224
NJG 2324 CV	120	260	86	1000	1240	125	1700	1900	22,3	3	147,4	5	SL19 2324
NCF 2926 CV	130	180	30	214	355	38	1400	1700	2,33	1,5	167,2	2	SL18 2926
NCF 3026 CV	130	200	52	435	620	65,1	1250	1500	5,65	2	185,5	5,5	SL18 3026
NCF 2226 CV	130	230	64	630	860	87,9	1300	1700	11,25	3	207,8	5	SL18 2226
NCF 2928 CV	140	190	30	232	385	40,4	1500	1600	2,42	1,5	180	2	SL18 2928

S*: indicates maximum axial displacement from the inner ring.

Cylindrical Roller Bearing

DATA TABLE - FULL COMPLEMENT / SINGLE ROW



Part number	Principal dimensions			Basic load ratings			Speed limits		Weight	Radius	Dimensions		ALT. CODE
	Bores	Outer	Width	Dynamic	Static	Fatigue	Grease	Oil			rs min	E & F	
	d	D	B	Cr	Cor	Pu	rpm		Kg	mm	mm		
	mm			kN			1 min ⁻¹						
NCF 3028 CV	140	210	53	455	680	70,1	1200	1500	6,04	2	196,5	5,5	SL18 3028
NCF 2228 CV	140	250	68	720	1020	102	1050	1300	14,47	3	226,6	5	SL18 2228
NCF 2930 CV	150	210	36	305	490	50,1	1200	1400	3,77	2	195,5	2,5	SL18 2930
NCF 3030 CV	150	225	56	480	710	71,7	900	1200	7,33	2,1	208	7	SL18 3030
NCF 2230 CV	150	270	73	830	1180	115	1000	1200	18,43	3	237,4	6	SL18 2230
NCF 2932 CV	160	220	36	320	520	52,3	850	1200	4	2	207,6	2,5	SL18 2932
NCF 3032 CV	160	240	60	550	820	81,2	900	1000	8,8	2,1	225,1	7	SL18 3032
NCF 2934 CV	170	230	36	330	560	55,5	950	1200	4,30	2	216	2,5	SL18 2934
NCF 3034 CV	170	260	67	710	1070	104	900	950	12,20	2,1	243,3	7	SL18 3034
NCF 2234 CV	170	310	86	1150	1680	158	800	850	28,65	3	281,9	7	SL18 2234
NCF 2936 CV	180	250	42	410	690	66,9	750	850	6,20	2	231	2,5	SL18 2936
NCF 3036 CV	180	280	74	820	1260	120	750	950	16,10	2,1	260	7	SL18 3036
NCF 2236 CV	180	320	86	1190	1780	165	700	750	29,80	4	294	7	SL18 2236
NCF 2938 CV	190	260	42	455	790	75,5	700	850	6,50	2	142,5	2,5	SL18 2938
NCF 3038 CV	190	290	75	840	1320	124	600	650	17	2,1	267,5	9	SL18 3038
NCF 2238 CV	190	340	92	1310	1920	175	600	800	35,65	4	311,5	19	SL18 2238
NCF 1840 CV	200	250	24	183	330	31,6	600	650	2,57	1,5	237,8	2	SL18 1840
NCF 2940 CV	200	280	48	550	960	90	550	600	9,10	2,1	261,2	3	SL18 2940
NCF 3040 CV	200	310	82	960	1530	141	650	900	21,80	2,1	286	9	SL18 3040
NCF 2240 CV	200	360	98	1420	2040	183	500	800	43,12	4	319,4	9	SL18 2240
NCF 1844 CV	220	270	24	192	365	34	650	1000	2,80	1,5	257,5	2	SL18 1844
NCF 2944 CV	220	300	48	580	1050	96,1	450	850	9,90	2,1	282	3	SL18 2944
NCF 3044 CV	220	340	90	1160	1840	165	440	850	28,40	3	312	9	SL18 3044
NCF 1848 CV	240	300	28	224	435	39,4	550	950	4,40	2	284	3	SL18 1848
NCF 2948 CV	240	320	48	610	1140	102	410	750	10,60	2,1	303	3	SL18 2948
NCF 3048 CV	240	360	92	1220	2010	176	370	750	30,90	3	335,6	11	SL18 3048
NCF 1852 CV	260	320	28	234	475	42,1	470	850	4,71	2	307	3	SL18 1852
NCF 2952 CV	260	360	60	790	1470	128	440	700	18,5	2,1	333,7	3,5	SL18 2952
NCF 3052 CV	260	400	104	1620	2550	217	420	650	44,5	4	373,5	11	SL18 3052
NCF 1856 CV	280	350	33	315	620	53,6	400	800	7	2	332	3	SL18 1856
NCF 2956 CV	280	380	60	920	1740	148	380	600	19,70	2,1	362,7	3,5	SL18 2956
NCF 3056 CV	280	420	106	1670	2700	226	360	600	48	4	391,5	11	SL18 3056
NCF 1860 CV	300	380	38	380	750	63,4	320	700	10	2,1	359	3,5	SL18 1860
NCF 2960 CV	300	420	72	1180	2230	185	300	550	31,20	3	390	5	SL18 2960
NCF 3060 CV	300	460	118	2040	3350	274	500	800	66,60	4	432	14	SL18 3060

S*: indicates maximum axial displacement from the inner ring.

Cylindrical Roller Bearing

DATA TABLE - FULL COMPLEMENT / SINGLE ROW



Part number	Principal dimensions			Basic load ratings			Speed limits		Weight	Radius	Dimensions		ALT. CODE
	Bore	Outer	Width	Dynamic	Static	Fatigue	Grease	Oil			rs min	E & F	
	d	D	B	Cr	Cor	Pu	rpm		Kg	mm			
	mm			kN			1 min ⁻¹						
NCF 1864 CV	320	400	38	390	800	66,4	600	650	10,60	2,1	377	4,5	SL18 1864
NCF 2964 CV	320	440	72	1220	2370	194	500	850	32,90	3	410	5	SL18 2964
NCF 3064 CV	320	480	121	2100	3500	282	500	800	71,70	4	447,3	14	SL18 3064
NCF 1868 CV	340	420	38	405	840	68,6	650	850	11,20	2,1	401	4,5	SL18 1868
NCF 2968 CV	340	460	72	1260	2500	201	480	800	34,70	3	432	5	SL18 2968
NCF 3068 CV	340	520	133	2500	4150	327	450	750	95,80	5	486	16	SL18 3068
NCF 1872 CV	360	440	38	426	890	71,6	550	800	11,70	2,1	419	4,5	SL18 1872
NCF 2972 CV	360	480	72	1290	2650	210	440	750	36,40	3	450,5	5	SL18 2972
NCF 3072 CV	360	540	134	2550	4350	338	430	700	101	5	503,2	16	SL18 3072
NCF 1876 CV	380	480	46	590	1190	93,7	550	750	19,20	2,1	456	6	SL18 1876
NCF 2976 CV	380	520	82	1670	3350	260	400	700	52,10	4	487	5	SL18 2976
NCF 3076 CV	380	560	135	2600	4500	345	410	700	106	5	520,5	16	SL18 3076
NCF 1880 CV	400	500	46	600	1260	97,9	490	700	20	2,1	472	6	SL18 1880
NCF 2980 CV	400	540	82	1730	3560	273	370	700	54,30	4	511	5	SL18 2980
NCF 3080 CV	400	600	148	3100	5400	406	360	650	140	5	559,1	18	SL18 3080
NCF 1884 CV	420	520	46	620	1310	100	470	700	20,90	2,1	496	6	SL18 1884
NCF 2984 CV	420	560	82	1750	3600	273	360	650	56,90	4	524	5	SL18 2984
NCF 3084 V	420	620	150	3300	6300	469	200	430	150	5	578,2		SL18 3084
NCF 1888 CV	440	540	46	630	1380	104	440	650	21,80	2,1	519	6	SL18 1888
NCF 2988 CV	440	600	95	2100	4150	309	330	600	78,10	4	565,5	7	SL18 2988
NCF 3088 V	440	650	157	3740	7350	539	190	400	175	6	607,5		SL18 088
NCF 1892 CV	460	580	56	790	1680	125	420	600	33,90	3	553	7	SL18 1892
NCF 2992 CV	460	620	95	2140	4300	316	320	600	81,10	4	579	7	SL18 2992
NCF 3092 V	460	680	163	4130	8000	579	180	380	195	6	635		SL18 3092
NCF 1896 CV	480	600	56	810	1740	128	400	600	35,20	3	573,5	7	SL18 1896
NCF 2896 V	480	600	72	1320	3150	232	190	400	46	3	573,5	5	SL18 2896
NCF 2996 CV	480	650	100	2410	4850	352	290	550	94,70	5	606	7	SL18 2996
NCF 3096 V	480	700	165	4180	8300	594	170	360	205	6	655,2		SL18 3096
NCF 18/500 CV	500	620	56	830	1830	133	380	600	36,50	3	594	7	SL18 18/500
NCF 28/500 V	500	620	72	1340	3350	244	180	380	48	3	594		SL18 28/500
NCF 29/500 CV	500	670	100	2450	5000	359	280	550	98,30	5	634,5	7	SL18 29/500
NCF 30/500 V	500	720	167	4290	8650	613	170	360	215	6	676,8		SL18 30/500
NCF 18/530 CV	530	650	56	900	2200	158	360	600	37,90	3	624,5	7	SL18 18/530
NCF 28/530 V	530	650	72	1400	3450	247	170	360	49,50	3	624,5	5	SL18 28/530
NCF 29/530 V	530	710	106	2700	6000	423	160	340	120	5	673	7	SL18 29/530

S*: indicates maximum axial displacement from the inner ring.

Cylindrical Roller Bearing

DATA TABLE - FULL COMPLEMENT / SINGLE ROW

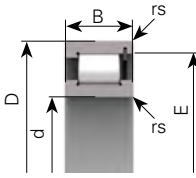

NCF



NJGV



Part number	Principal dimensions			Basic load ratings			Speed limits		Weight	Radius	Dimensions		ALT. CODE
	Bores	Outer	Width	Dynamic	Static	Fatigue	Grease	Oil			rs min	E & F	
	d	D	B	Cr	Cor	Pu	rpm		Kg	mm	mm		
NCF 30/530 V	530	780	185	5230	10600	736	150	320	300	6	732,3	16	SL18 30/530
NCF 18/560 CV	560	680	56	1020	2360	166	340	600	39,30	3	655	7	SL18 18/560
NCF 28/560 V	560	680	72	1420	3650	257	160	340	54	3	651,5	4,3	SL18 28/560
NCF 29/560 V	560	750	112	3030	6700	465	150	320	140	5	709	7	SL18 29/560
NCF 30/560 V	560	820	195	5830	11800	806	140	300	345	6	770	16	SL18 30/560
NCF 18/600 CV	600	730	60	1140	2680	185	320	600	51,30	3	696	7	SL18 18/600
NCF 29/600 V	600	800	118	3360	7500	510	140	300	170	5	754	7	SL18 29/600
NCF 18/630 CV	630	780	69	1470	3400	231	300	600	75,50	4	739	7	SL18 18/630
NCF 29/630 V	630	850	128	3740	8650	579	130	280	205	6	807	8	SL18 29/630
NCF 18/670 CV	670	820	69	1520	3550	237	280	600	72,70	4	783	7	SL18 18/670
NCF 29/670 V	670	900	136	3800	8650	569	120	260	245	6	846	10	SL18 29/670
NCF 29/710 V	710	950	140	3910	9150	591	110	240	275	6	896	10	SL18 29/710
NCF 18/750 CV	750	920	78	1820	4500	290	110	240	105,60	5	880	9	SL18 18/750
NCF 28/750 V	750	920	100	2510	6800	439	110	240	140	5	880	8	SL18 28/750
NCF 29/750 V	750	1000	145	4460	10600	674	100	220	315	6	938	11	SL18 29/750
NCF 18/800 V	800	980	82	1940	4800	304	100	220	130	5	936	10	SL18 18/800
NCF 28/800 V	800	980	106	2750	7500	475	100	220	165	5	936	10	SL18 28/800
NCF 29/800 V	800	1060	150	4950	12200	762	95	200	360	6	1002	11	SL18 29/800
NCF 18/850 CV	850	1030	82	2050	5200	324	95	200	135	5	986	9	SL18 18/850
NCF 29/850 CV	850	1120	155	5280	12900	792	90	190	405	6	1061	12	SL18 29/850
NCF 29/900 V	900	1180	165	5940	14600	882	80	170	472	6	1120	13	SL18 29/900
NCF 29/950 V	950	1250	175	6660	16300	968	75	160	565	7,5	1179	14	SL18 29/950
NCF 29/1000 V	1000	1320	185	7480	18600	1087	70	150	680	7,5	1252	14	SL18 29/1000
NCF 18/1120 V	1120	1360	106	9960	3720	213	130	175	366	6	1279	12	SL18 18/1120
NCF 18/1400 V	1400	1700	132	15320	5350	287	90	125	740	7,5		18	SL18 18/1400

S*: indicates maximum axial displacement from the inner ring.

TECHNICAL NOTEBOOK

ROLLWAY®

FULL COMPLEMENT

CYLINDRICAL ROLLER BEARING

DOUBLE ROW



In this section:

	Page
Design Characteristics Applications Angular Misalignment	
ISO Specification	112
Series Nomenclature Equivalent Load Equations	
Lubrication Radial Clearance Tables	113
Data Tables	114-118

REGAL®

Cylindrical Roller Bearing

FULL COMPLEMENT - DOUBLE ROW

DESIGN | CHARACTERISTICS | APPLICATIONS

The double row full complement cylindrical roller bearing have the same characteristics then the single row design but with even more higher load ratings.

Four designs are available in 4 NNCF NNCL NNC NNF . Unless the NNF, all these designs have a inner ring with 3 roller guiding shoulder. The outer rings have different designs:

NNCF design: 1 shoulder and 1 snap ring

NNCL design: flat outer ring with a central snap ring

NNC design: 2 outer ring with 1 shoulder. The 2 rings are held together with 3 springs.

NNF design: Has an outer ring with 3 shoulders and 2 inner rings with 1 shoulder each. The 2 inner rings are held together with a metallic ring. This bearing has 2 seals, is lubricated and has 2 snap rings on the outer ring for easy locating.



NNCF CV

NNCL CV

NNC CV

NNF PP 2RN

ANGULAR MISALIGNMENT

The following is an approximate guide to the misalignment that can be accommodated in a cylindrical roller bearing:

0.0004 radians

Greater misalignment under heavy radial load can be critical.

ISO SPECIFICATIONS

- Dimensions in accordance with ISO 15 (latest version)
- Precision class in accordance with ISO 492 (latest version)
- Radial clearance in accordance with ISO 5753 (latest version)

SERIES



NNC 4800



NNC 4900



NNF 5000

NOMENCLATURE

Prefixes:

R : Bearing without outer ring

Suffixes:

PP : 2 silicone seals in combination with the NNF design

NR : Snap ring groove in the outer ring, including 2 snap ring
in combination with the NNF design

C2 - C4 : Radial clearance class

P0 - P6 : Precision class

EQUIVALENT LOAD EQUATIONS

Refer to the cylindrical roller bearing chapter for the equivalent load calculation (page 63-65).

LUBRICATION

The NNF bearing is lubricate with Lithium based grease and with a fill rate of 30%. The viscosity is 120 ISO VG.

RADIAL CLEARANCE TABLES

Refer to the cylindrical roller bearing chapter for the radial clearance tables (page 66).

Cylindrical Roller Bearing

DATA TABLE - FULL COMPLEMENT / DOUBLE ROW



Part number	Principal dimensions			Basic load ratings			Speed limits		Weight	Radius		Dimensions				
	Bore	Outer	Width	Dynamic	Static	Fatigue	Grease	Oil		rs min	C	S	C1	m	X	
	d	D	B	Cr	Cor	Pu	rpm	Kg	mm							mm
NNF 5004 PP 2NR	20	42	30	40,5	49	5,98	4000		0,20	0,3	29		24,7	1,8	22,5	
NNCF 5004 CV	20	42	30	47,5	53	6,46	9000	10000	0,20	0,6		1				
NNF 5005 PP 2NR	25	47	30	44,5	58	7,07	3600		0,24	0,3	29		24,7	1,8	22,5	
NNCF 5005 CV	25	47	30	54	65	7,93	7000	9000	0,23	0,6		1				
NNF 5006 PP 2NR	30	55	34	50	67	8,17	3000		0,37	0,3	33		28,2	2,1	25,5	
NNCF 5006 CV	30	55	34	70	86	10,5	6500	7500	0,35	1		1,5				
NNF 5007 PP 2NR	35	62	36	69	88	10,7	2600		0,48	0,3	35		30,2	2,1	27,5	
NNCF 5007 CV	35	62	36	85	109	13,3	5500	6500	0,46	1		1,5				
NNF 5008 PP 2NR	40	68	38	76	103	12,6	2400		0,56	0,6	37		32,2	2,7	28,5	
NNCF 5008 CV	40	68	38	101	136	16,6	5000	6000	0,56	1		1,5				
NNF 5009 PP 2NR	45	75	40	92	130	15,9	2200		0,70	0,6	39		34,2	2,7	30,5	
NNCF 5009 CV	45	75	40	108	151	18,4	4700	5500	0,71	1		1,5				
NNF 5010 PP 2NR	50	80	40	97	142	17,3	2000		0,76	0,6	39		34,2	2,7	30,5	
NNCF 5010 CV	50	80	40	131	191	23,3	4200	5000	0,76	1	40	1,5				
NNF 5011 PP 2NR	55	90	46	115	175	21,3	1800		1,18	0,6	45		40,2	3,2	36	
NNCF 5011 CV	55	90	46	184	275	33,5	3800	4500	1,16	1,1		1,5				
NNC 4912 CV	60	85	25	71	125	15,2	3200	4500	0,49	1						
NNCL 4912 CV	60	85	25	71	125	15,2	3200	4500	0,47	1		1				
NNF 5012 PP 2NR	60	95	46	120	189	23,0	1700		1,26	0,6	45		40,2	3,2	36	
NNCF 5012 CV	60	95	46	189	290	35,4	3400	4200	1,24	1,1		1,5				
NNF 5013 PP 2NR	65	100	46	125	203	24,8	1600		1,33	0,6	45		40,2	3,2	36	
NNCF 5013 CV	65	100	46	199	320	39,0	3100	3900	1,32	1,1		1,5				
NNC 4914 CV	70	100	30	108	189	23,0	2800	3800	0,78	1						
NNCL 4914 CV	70	100	30	108	189	23,0	2800	3800	0,75	1		1				
NNF 5014 PP 2NR	70	110	54	168	265	32,3	1400		1,87	0,6	53		48,2	4,2	42	
NNCF 5014 CV	70	110	54	235	355	43,3	3100	3600	1,85	1,1		3				
NNF 5015 PP 2NR	75	115	54	194	300	36,6	1400		1,96	0,6	53		48,2	4,2	42	
NNCF 5015 CV	75	115	54	248	390	47,6	2700	3400	1,93	1,1		3				
NNC 4916 CV	80	110	30	115	211	25,7	2500	3400	0,88	1						
NNCL 4916 CV	80	110	30	115	211	25,7	2500	3400	0,85	1		1				
NNF 5016 PP 2NR	80	125	60	203	325	39,3	1300		2,71	0,6	59		54,2	4,2	48	
NNCF 5016 CV	80	125	60	295	450	54,5	2500	3200	2,59	1,1		3,5				
NNF 5017 PP 2NR	85	130	60	211	350	41,8	1200		2,83	0,6	59		54,2	4,2	48	
NNCF 5017 CV	85	130	60	305	475	56,7	2400	3000	2,72	1,1		3,5				
NNC 4918 CV	90	125	35	155	295	35,2	2300	3000	1,35	1,1						

Cylindrical Roller Bearing

DATA TABLE - FULL COMPLIMENT / DOUBLE ROW

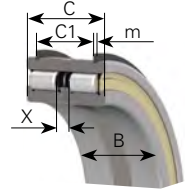
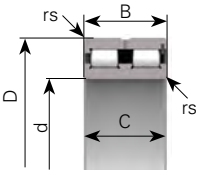

NNCF CV

NNCL CV

NNC CV

NNF PP 2NR

Part number	Principal dimensions			Basic load ratings			Speed limits		Weight	Radius	Dimensions				
	Bore	Outer	Width	Dynamic	Static	Fatigue	Grease	Oil			rs min	C	S	C1	m
	d	D	B	Cr	Cor	Pu	rpm		Kg	mm	mm	mm	mm	mm	mm
NNCL 4918 CV	90	125	35	155	295	35,2	2300	3000	1,30	1,1		1,5			
NNF 5018 PP 2NR	90	140	67	305	510	59,6	1100		3,71	0,6	66		59,2	4,2	54
NNCF 5018 CV	90	140	67	355	560	65,5	2200	2800	3,62	1,5		4			
NNF 5019 PP 2NR	95	145	67	315	530	61,2	1100		3,88	0,6	66		59,2	4,2	54
NNC 4920 CV	100	140	40	196	380	43,9	2000	2700	1,95	1,1					
NNCL 4920 CV	100	140	40	196	380	43,9	2000	2700	1,90	1,1		2			
NNF 5020 PP 2NR	100	150	67	330	550	62,7	1000		3,95	0,6	66		59,2	4,2	54
NNCF 5020 CV	100	150	67	375	620	70,7	2000	2600	3,94	1,5		4			
NNC4922 CV	110	150	40	204	410	46,2	1800	2500	2,15	1,1					
NNCL 4922 CV	110	150	40	204	410	46,2	1800	2500	2,10	1,1		2			
NNF 5022 PP 2NR	110	170	80	395	680	75,0	900		6,57	0,6	79		70,2	4,2	64
NNCF 5022 CV	110	170	80	490	790	87,1	1800	2300	6,32	2		5			
NNC 4924 CV	120	165	45	228	455	49,9	1700	2300	2,95	1,1					
NNCL4924 CV	120	165	45	228	455	49,9	1700	2300	2,85	1,1		3			
NNF 5024 PP 2NR	120	180	80	410	740	79,9	900		7,04	0,6	79	4	71,2	4,2	64
NNCF 5024 CV	120	180	80	520	870	93,9	1600	2200	6,77	2		5			
NNC 4926 CV	130	180	50	265	530	56,7	1500	2100	3,95	1,5		4			
NNCL 4926 CV	130	180	50	265	530	56,7	1500	2100	3,80	1,5		4			
NNF 130 PP 2NR	130	190	80	430	790	83,7	800		7,50	0,6	79		71,2	4,2	64
NNF 5026 PP 2NR	130	200	95	540	960	101	800		10,50	0,6	94		83,2	4,2	77
NNCF 5026 CV	130	200	95	740	1230	129	1400	2000	10,20	2		5			
NNC 4928 CV	140	190	50	275	570	59,8	1400	2000	4,20	1,5					
NNCL 4928 CV	140	190	50	275	570	59,8	1400	2000	4,10	1,5		4			
NNF 140 PP 2NR	140	200	80	445	840	87,4	750		8	0,6	79		72,1	4,2	64
NNF 5028 PP 2NR	140	210	95	610	1100	113	750		11,10	0,6	94		83,2	5,2	77
NNCF 5028 CV	140	210	95	780	136	14,0	1200	1900	11,10	2		5			
NNC 4830 CV	150	190	40	237	550	57,2	1300	1900	2,90	1,1					
NNCL 4830 CV	150	190	40	237	550	57,2	1300	1900	2,80	2		2			
NNCF 4830 V	150	190	40	230	580	60,3	1500	1200	2,80						
NNC 4930 CV	150	210	60	415	840	85,9	1200	1800	6,65	2					
NNCL 4930 CV	150	210	60	415	840	85,9	1200	1900	6,45	2		4			
NNF 150 PP 2NR	150	210	80	465	920	94,1	700		8,40	0,6	79		71,2	5,2	64
NNF 5030 PP 2NR	150	225	100	710	1260	127	700		13,30	0,6	99		87,2	5,2	80
NNCF 5030 CV	150	225	100	820	1420	143	1200	1700	13,30	2		6			
NNC 4832 CV	160	200	40	243	580	59,3	1300	1800	3,10	2,1					

Cylindrical Roller Bearing

DATA TABLE - FULL COMPLEMENT / DOUBLE ROW



Part number	Principal dimensions			Basic load ratings			Speed limits		Weight	Radius		Dimensions				
	Bore	Outer	Width	Dynamic	Static	Fatigue	Grease	Oil		rs min	C	S	C1	m	X	
	d	D	B	Cr	Cor	Pu	rpm	Kg	mm							mm
NNCL 4832 CV	160	220	40	243	580	59,3	1200	1800	3	1,1		2				
NNC 4932 CV	160	220	60	435	900	90,5	1100	1700	7	2						
NNCL 4936 CV	160	220	60	435	900	90,5	1100	1700	6,80	2		4				
NNF 160 PP 2NR	160	220	80	480	970	97,6	700		8,80	0,6	79		71,2	5,2	64	
NNF 5032 PP 2NR	160	240	109	740	1360	135	650		16,60	0,6	108		95,2	5,2	89	
NNCF 5032 CV	160	240	109	895	1620	160	1200	1500	15,80	2,1		6				
NNC 4834 CV	170	215	40	265	620	62,1	1200	1700	4,1	1,1						
NNCL 4834 CV	170	215	40	265	620	62,1	1200	1700	3,95	1,1		3				
NNC 4934 CV	170	230	60	445	950	94,1	1000	1600	7,35	2						
NNCL 4934 CV	170	230	60	445	950	94,1	1000	1600	7,10	2		4				
NNF 170 PP 2NR	170	230	80	490	1030	102	650		9,30	0,6	79		71,2	5,2	64	
NNF 5034 PP 2NR	170	260	122	960	1750	170	600		22,60	0,6	121		107,2	5,2	100	
NNCF 5034 CV	170	260	122	1230	2120	205	1100	1400	23	2,1		6				
NNC 4836 CV	180	225	45	275	660	65,1	1100	1600	4,30	1,1						
NNCL 4836 CV	180	225	45	275	660	65,1	1100	1600	4,15	1,1		3				
NNF 180 PP 2NR	180	240	80	500	1080	105	600		9,80	0,6	79		71,2	5,2	64	
NNC 4936 CV	180	250	69	580	1230	119	950	1500	10,80	2						
NNCL 4936 CV	180	250	69	580	1230	119	950	1500	10,50	2		4				
NNF 5036 PP 2NR	180	280	136	1140	2130	202	550		30,10	0,6	135		118,2	5,2	112	
NNCF 5036 CV	180	280	136	1420	2500	237	1100	1300	30,50	2,1		8				
NNC 4838 CV	190	240	50	315	750	72,7	1100	1500	5,65	1,5						
NNCL 4838 CV	190	240	50	315	750	72,7	1100	1500	5,45	1,5		4				
NNC 4938 CV	190	260	69	590	1290	123	900	1400	11,20	2						
NNCL 4938 CV	190	260	69	590	1290	123	900	1400	10,90	2		4				
NNF 190 PP 2NR	190	260	80	520	1130	108	550		12,70	0,6	79		73,2	5,2	64	
NNF 5038 PP 2NR	190	290	136	1160	2210	207	550		31,50	0,6	135		118,2	5,2	112	
NNCF 5038 CV	190	290	136	1470	2600	244	1000	1300	31,50	2,1		8				
NNC 4840 CV	200	250	50	325	790	75,5	1000	1400	5,90	1,5						
NNCL 4840 CV	200	250	50	325	790	75,5	1000	1400	5,70	1,5		4				
NNF 200 PP 2NR	200	270	80	540	1210	114	550		13,20	0,6	79		73,2	5,2	64	
NNC 4940 CV	200	280	80	690	1480	139	850	1400	15,80	2,1						
NNCL 4940 CV	200	280	80	690	1480	139	850	1400	15,30	2,1		5				
NNF 5040 PP 2NR	200	310	150	1350	2600	239	500		40,80	0,6	149		128,2	6,3	126	
NNCF 5040 CV	200	310	150	1860	3050	281	950	1200	41	2,1		9				
NNC 4844 CV	220	270	50	340	870	81,1	850	1300	6,40	1,5						

Cylindrical Roller Bearing

DATA TABLE - FULL COMPLEMENT / DOUBLE ROW

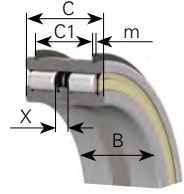
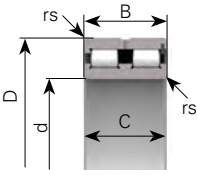

NNCF CV

NNCL CV

NNC CV

NNF PP 2NR

Part number	Principal dimensions			Basic load ratings			Speed limits		Weight	Radius	Dimensions				
	Bore	Outer	Width	Dynamic	Static	Fatigue	Grease	Oil			rs min	C	S	C1	m
	d	D	B	Cr	Cor	Pu	rpm		Kg	mm	mm				
	mm			kN			1 min ⁻¹								
NNCL 4844 CV	220	270	50	340	870	81,1	850	1300	6,20	1,5		4			
NNC 4944 CV	220	300	80	720	1590	146	750	1200	17,20	2,1					
NNCL 4944 CV	220	300	80	720	1590	146	750	1200	16,70	2,1		5			
NNF 220 PP 2NR	220	300	95	700	1550	142	480		19,50	1	94		83,2	5,2	72
NNF 5044 PP 2NR	220	340	160	1570	3050	273	480		52,50	1	159		138,2	6,3	132
NNCF 5044 CV	220	340	160	2010	3600	322	850	1100	52,50	3		9			
NNC 4848 CV	240	300	60	520	1290	117	750	1200	10	2					
NNCL 4848 CV	240	300	60	520	1290	117	750	1200	9,90	2		4			
NNC 4948 CV	240	320	80	750	1740	156	700	1200	18,50	2,1					
NNCL 4948 CV	240	320	80	750	1740	156	700	1200	17,90	2,1		5			
NNF 240 PP 2NR	240	320	95	740	1700	152	480		21	1	94		83,2	6,3	72
NNF 5048 PP 2NR	240	360	160	1630	3300	289	440		56	1	159		138,2	6,3	132
NNCF 5048 CV	240	360	160	2120	3900	342	800	1000	56	3		9			
NNC 4852 CV	260	320	60	540	1400	124	700	1100	11	2					
NNCL 4852 CV	260	320	60	540	1400	124	700	1100	10,60	2		4			
NNF 260 PP 2NR	260	340	95	840	1990	175	440		22,50	1	94		83,2	6,3	75
NNC 4952 CV	260	360	100	1120	2500	217	600	1000	32	2,1					
NNCL 4952 CV	260	360	100	1120	2500	217	600	1000	31,20	2,1		6			
NNF 5052 PP 2NR	260	400	190	2380	4700	401	400		84,50	1,1	189		162,2	6,3	150
NNCF 5052 CV	260	400	190	2860	5200	443	700	900	85,50	4		10			
NNC 4856 CV	280	350	69	710	1860	161	600	1000	16	2					
NNCL 4856 CV	280	350	69	710	1860	161	600	1000	15,60	2		4			
NNC 4956 CV	280	380	100	1170	2700	230	550	1000	34	2,1					
NNCL 4956 CV	280	380	100	1170	2700	230	550	1000	33,10	2,1		6			
NNF 5056 PP 2NR	280	420	190	2600	5200	435	380		90	1,1	189		163,2	7,3	150
NNCF 5056 CV	280	420	190	2920	5600	469	670	850	90,50	4		10			
NNC 4860 CV	300	380	80	830	2120	179	550	950	23	2,1					
NNCL 4860 CV	300	380	80	830	2120	179	550	950	22	2,1		6			
NNCF 4860 V	300	380	80	792	2120	179	700	380	23	2,1					
NNF 300 PP 2NR	300	380	95	900	2250	190	380		25,50	1	94		83,2	6,3	75
NNC 4960 CV	300	420	118	1650	3800	316	460	900	53	3					
NNCL 4960 CV	300	420	118	1650	3800	316	460	900	51,90	3		6			
NNF 5060 PP 2NR	300	460	218	3000	5800	474	340		126	1,1	216		185,2	7,3	170
NNCF 5060 CV	300	460	218	3250	6550	535	600	750	130	4		9			
NNC 4864 CV	320	400	80	860	2280	189	500	900	24	2,1					

Cylindrical Roller Bearing

DATA TABLE - FULL COMPLEMENT / DOUBLE ROW



Part number	Principal dimensions			Basic load ratings			Speed limits		Weight	Radius	Dimensions				
	Bore	Outer	Width	Dynamic	Static	Fatigue	Grease	Oil			rs min	C	S	C1	m
	d	D	B	Cr	Cor	Pu	rpm		Kg	mm		mm			
mm			kN			1 min ⁻¹									
NNCL 4864 CV	320	400	80	860	2280	189	500	900	23,50	2,1		6			
NNC 4964 CV	320	440	118	1720	4100	335	410	850	56	3					
NNCL 4964 CV	320	440	118	1720	4100	335	410	850	54,90	3		6			
NNCF 5064 CV	320	480	218	3690	6950	559	560	700	135	4		9			
NNC 4868 CV	340	420	80	880	2390	195	480	850	25,50	2,1					
NNCL 4868 CV	340	420	80	880	2390	195	480	850	25	2,1		6			
NNC 4968 CV	340	460	118	1770	4300	346	390	800	59	3					
NNCL 4968 CV	340	460	118	1770	4300	346	390	800	57,80	3		6			
NNCF 5068 CV	340	520	243	4400	8300	653	530	670	185	5		11			
NNC 4872 CV	360	440	80	910	2550	205	440	800	27	2,1					
NNCL 4872 CV	360	440	80	910	2550	205	440	800	26	2,1		6			
NNC 4972 CV	360	480	118	1810	4500	357	370	750	62,10	3					
NNCL 4972 CV	360	480	118	1810	4500	357	370	750	60,80	3		6			
NNCF 5072 CV	360	540	243	4460	8650	672	500	630	195	5		11			
NNC 4876 CV	380	480	100	1330	3550	279	400	750	45,50	2,1					
NNCL 4876 CV	380	480	100	1330	3550	279	400	750	44	2,1		6			
NNCL 4976 CV	380	520	140	2280	5600	435	340	700	90,50	4		7			
NNC 4976 CV	380	520	140	2280	5600	435	340	700	92,40	4					
NNCF 5076 CV	380	560	243	4680	9150	701	480	600	200	5		11			
NNC 4980 CV	400	540	140	2340	5900	452	310	700	96,50	4					
NNCL 4980 CV	400	540	140	2340	5900	452	310	700	96,50	4		7			

TECHNICAL NOTEBOOK

SPHERICAL ROLLER BEARING

ROLLWAY®



In this section:

	Page
Design Characteristics Applications	120
Angular Misalignment ISO Specification Series.....	121
Nomenclature Equivalent Load Equations	122
Shields Seals Lubrication	123
Radial Clearance Tables.....	124-127
Data Tables	128-137

REGAL®

Spherical Roller Bearing

DESIGN | CHARACTERISTICS | APPLICATIONS

The spherical roller bearing design is made of two rows of spherical rollers running in separate raceways on the inner ring. The inner ring has shoulders to guide the rollers. The outer ring has a single spherical raceway, thus allowing the inner ring and rollers to freely compensate for angular errors due to inaccurate machine components or due to elastic deflection of the shaft or housing under load.

As a result of the line contact, a large number of rollers, and the substantial contact angle, these bearings have large radial and thrust load capacity. They are suitable for heavy shock and impact loads and thus are extensively used in steel mills, rock crushers, and heavy industrial equipment.

Rollway spherical roller bearing standard cage is a single piece brass cage. Other cage designs are available.

Spherical roller bearings can be manufactured with tapered bore-K(1:12) or K30 (1:30) and have all lubrication groove and 3 lubrication holes on the outside ring W33.

Sealed bearings are available in series 222 and 223 and have a steel cage combined with 2 NBR seals or 2VS seals. The width of these bearings can differ from the standard bearing width.

The vibrations screen bearings are described in the next chapter.

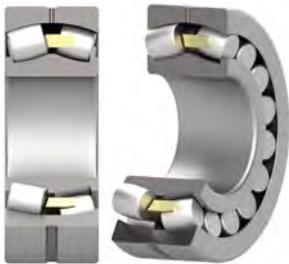

GMEX



CA



C



C 2RS

ANGULAR MISALIGNMENT

The following is an approximate guide to the misalignment that can be accommodated in a spherical roller bearing-between 1 and 2,5 degrees depending on which series is being used:

Bearing Series	Permissible angular misalignment degrees
213	1.0
222	1.5
223	2.0
230	1.5
231	1.5
232	2.5
240	2.0
241	2.5

ISO SPECIFICATIONS

- Dimensions in accordance with ISO 15 (latest version)
- Precision class in accordance with ISO 492 (latest version)
- Radial clearance in accordance with ISO 5753 (latest version)

SERIES

The series below are the most popular:

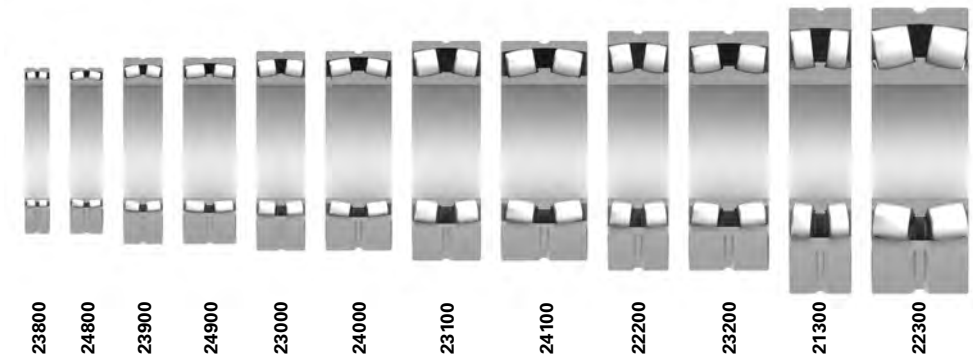

Spherical Roller Bearing

NOMENCLATURE

Suffixes:

- GMEX : Single piece, brass cage, roller guided (d = 25mm - 240mm)
- CA : Single piece, brass cage, roller guided (d = 260mm - 1000mm)
- C 2RS : Steel cage & 2 NBR seals, filled with Lithium base grease.
Peak operating temperature is 100°C
- 2VS : 2 Fluorine rubber seals, filled with high temperature grease.
Peak operating temperature is 200°C
- K : Tapered bore 1/12
- K30 : Tapered bore 1/30 for series 240/241
- C2 - C4 : Radial clearance class
- P0 - P6 : Precision class
- W33 : Lubrication groove and 3 lubrication holes on the outside ring

EQUIVALENT LOAD EQUATIONS

Equivalent dynamic load P_e

$$P = F_r + Y_1 F_a \quad \text{when } F_a/F_r \leq e$$

$$P = 0.67 \cdot F_r + Y_2 \cdot F_a \quad \text{when } F_a/F_r > e$$

Values for Y_1 , Y_2 and e are given in the bearing tables.

Equivalent static load P_o

$$P_o = F_r + Y_o F_a$$

Values for Y_o are given in the bearing tables.

Axial load capacity when mounted on adapter sleeves

When spherical roller bearings are mounted on adapter sleeves fitted on smooth shafts, the axial load it will carry depends on the friction between the sleeve bore and the shaft.

The allowable axial load can be calculated by the formula:

$$F_{az} = 3 B d$$

Where F_{az} = maximum permissible axial load [N]

B = bearing width mm

d = bearing bore diameter mm

SHIELDS | SEALS



SEAL | 2RS

The contact seals (2RS) are made from NBR - Nitril Butadiene Rubber – and are reinforced with a metallic washer. The seals can withstand operating temperatures of 120°C.

For higher temperature 2 Fluorine Rubber seals (2VS) are recommended. The seals can withstand operating temperatures of 200°C.

LUBRICATION

A variation of lubricants are available for sealed spherical roller bearings.

Standard sealed bearings are lubricate with lithium based grease and have a fill rate of 30%. The grease viscosity is 100 ISO VG withstand operating temperatures of 120°C.

2VS sealed bearings are filled with a high temperature grease. The high temperature grease accordingly to customer requirement.



Spherical Roller Bearing

RADIAL CLEARANCE TABLES

For cylindrical bore



Nominal Bore diameter		Symbol of clearance group											
d		C1		C2		CN		C3		C4		C5	
Radial clearance of bearing μm													
over	up to	min.	max.	min.	max.	min.	max.	min.	max.	min.	max.	min.	max.
14	24	0	10	10	20	20	35	35	45	45	60	60	75
24	30	0	15	15	25	25	40	40	55	55	75	75	95
30	40	0	15	15	30	30	45	45	60	60	80	80	100
40	50	0	20	20	35	35	55	55	75	75	100	100	125
50	65	0	20	20	40	40	65	65	90	90	120	120	150
65	80	5	30	30	50	50	80	80	110	110	145	145	180
80	100	5	35	35	60	60	100	100	135	135	180	180	225
100	120	5	40	40	75	75	120	120	160	160	210	210	260
120	140	5	50	50	95	95	145	145	190	190	240	240	300
140	160	10	60	60	110	110	170	170	220	220	280	280	350
160	180	10	65	65	120	120	180	180	240	240	310	310	390
180	200	10	70	70	130	130	200	200	260	260	340	340	430
200	225	10	80	80	140	140	220	220	290	290	380	380	470
225	250	15	90	90	150	150	240	240	320	320	420	420	520
250	280	15	100	100	170	170	260	260	350	350	460	460	570
280	315	15	110	110	190	190	280	280	370	370	500	500	630
315	355	20	120	120	200	200	310	310	410	410	550	550	690
355	400	20	130	130	220	220	340	340	450	450	600	600	750
400	450	20	140	140	240	240	370	370	500	500	660	660	820
450	500	20	140	140	260	260	410	410	550	550	720	720	900
500	560	20	150	150	280	280	440	440	600	600	780	780	1000
560	630	30	170	170	310	310	480	480	650	650	850	850	1100
630	710	30	190	190	350	350	530	530	700	700	920	920	1190
710	800	30	210	210	390	390	580	580	770	770	1010	1010	1300
800	900	30	230	230	430	430	650	650	860	860	1120	1220	1440
900	1000	40	260	260	480	480	710	710	930	930	1220	1220	1570

RADIAL CLEARANCE TABLES

For tapered bore



Nominal Bore diameter		Symbol of clearance group											
d		C1		C2		CN		C3		C4		C5	
Radial clearance of bearing μm													
over	up to	min.	max.	min.	max.	min.	max.	min.	max.	min.	max.	min.	max.
18	24	5	15	15	25	25	35	35	45	45	60	60	75
24	30	10	20	20	30	30	40	40	55	55	75	75	95
30	40	15	25	25	35	35	50	50	65	65	85	85	105
40	50	15	30	30	45	45	60	60	80	80	100	100	130
50	65	25	40	40	55	55	75	75	95	95	120	120	160
65	80	30	50	50	70	70	95	95	120	120	150	150	200
80	100	30	55	55	80	80	110	110	140	140	180	180	230
100	120	40	65	65	100	100	135	135	170	170	220	220	280
120	140	50	80	80	120	120	160	160	200	200	260	260	330
140	160	55	90	90	130	130	180	180	230	230	300	300	380
160	180	65	100	100	140	140	200	200	260	260	340	340	430
180	200	70	110	110	160	160	220	220	290	290	370	370	470
200	225	70	120	120	180	180	250	250	320	320	410	410	520
225	250	90	140	140	200	200	270	270	350	350	450	450	570
250	280	90	150	150	220	220	300	300	390	390	490	490	620
280	315	100	170	170	240	240	330	330	430	430	540	540	680
315	355	120	190	190	270	270	360	360	470	470	590	590	740
355	400	130	210	210	300	300	400	400	520	520	650	650	820
400	455	140	230	230	330	330	440	440	570	570	720	720	910
450	500	160	260	260	370	370	490	490	630	630	790	790	1000
500	560	180	290	290	410	410	540	540	680	680	870	870	1100
560	630	200	320	320	560	560	600	600	760	760	980	980	1200
630	710	210	350	350	510	510	670	670	850	850	1090	1090	1360
710	800	230	390	390	570	570	750	750	960	960	1220	1220	1500
800	900	250	440	440	640	640	840	840	1070	1070	1370	1370	1690
900	1000	280	490	490	710	710	930	930	1190	1190	1520	1520	1860

Spherical Roller Bearing

RADIAL CLEARANCE REDUCTION OF SPHERICAL ROLLER BEARINGS WITH TAPERED BORE

During mounting, the radial clearance should meet the below data.

Bore diameter		Radial clearance prior to mounting						Reduction in radial clearance	
d		CN		C3		C4			
over	up to	min.	max.	min.	max.	min.	max.	min.	max.
mm		mm						mm	
24	30	0,03	0,04	0,04	0,055	0,055	0,075	0,015	0,02
30	40	0,035	0,05	0,05	0,065	0,065	0,085	0,02	0,025
40	50	0,045	0,06	0,06	0,08	0,08	0,1	0,025	0,03
50	65	0,055	0,075	0,075	0,095	0,095	0,12	0,03	0,04
65	80	0,07	0,095	0,095	0,12	0,12	0,15	0,04	0,05
80	100	0,08	0,11	0,11	0,14	0,14	0,18	0,045	0,06
100	120	0,1	0,135	0,135	0,17	0,17	0,22	0,05	0,07
120	140	0,12	0,16	0,16	0,2	0,2	0,26	0,065	0,09
140	160	0,13	0,18	0,18	0,23	0,23	0,3	0,075	0,1
160	180	0,14	0,2	0,2	0,26	0,26	0,34	0,08	0,11
180	200	0,16	0,22	0,22	0,29	0,29	0,37	0,09	0,13
200	225	0,18	0,25	0,25	0,32	0,32	0,41	0,1	0,14
225	250	0,2	0,27	0,27	0,35	0,35	0,45	0,11	0,15
250	280	0,22	0,3	0,3	0,39	0,39	0,49	0,12	0,17
280	315	0,24	0,33	0,33	0,43	0,43	0,54	0,13	0,19
315	355	0,27	0,36	0,36	0,47	0,47	0,59	0,15	0,21
355	400	0,3	0,4	0,4	0,52	0,52	0,65	0,17	0,23
400	450	0,33	0,44	0,44	0,57	0,57	0,72	0,2	0,26
450	500	0,37	0,49	0,49	0,63	0,63	0,79	0,21	0,28
500	560	0,41	0,54	0,54	0,68	0,68	0,87	0,24	0,32
560	630	0,46	0,6	0,6	0,76	0,76	0,98	0,26	0,35
630	710	0,51	0,67	0,67	0,85	0,85	1,09	0,3	0,4
710	800	0,57	0,75	0,75	0,96	0,96	1,22	0,34	0,45
800	900	0,64	0,84	0,84	1,07	1,07	1,37	0,37	0,5
900	1000	0,71	0,93	0,93	1,19	1,19	1,52	0,41	0,55
1000	1120	0,78	1,02	1,02	1,3	1,3	1,65	0,45	0,6
1120	1250	0,86	1,12	1,12	1,42	1,42	1,8	0,49	0,65
1250	1400	0,94	1,22	1,22	1,55	1,55	1,96	0,55	0,72

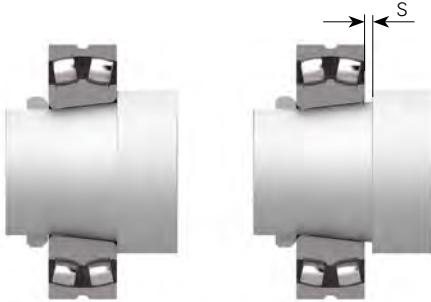

Axial displacement on 1:12 taper				Axial displacement on 1:30 taper				Smallest radial clearance after mounting		
Shaft		Sleeve		Shaft		Sleeve		CN	C3	C4
min.	max.	min.	max.	min.	max.	min.	max.	min.	min.	min.
0,3	0,35	0,3	0,4	-	-	-	-	0,015	0,02	0,035
0,35	0,4	0,35	0,45	-	-	-	-	0,015	0,025	0,04
0,4	0,45	0,45	0,5	-	-	-	-	0,02	0,03	0,05
0,45	0,6	0,5	0,7	-	-	-	-	0,025	0,035	0,055
0,6	0,75	0,7	0,85	-	-	-	-	0,025	0,04	0,07
0,7	0,9	0,75	1	1,7	2,2	1,8	2,4	0,035	0,05	0,08
0,7	1,1	0,8	1,2	1,9	2,7	2	2,8	0,05	0,065	0,1
1,1	1,4	1,2	1,5	2,7	3,5	2,8	3,6	0,055	0,08	0,11
1,2	1,6	1,3	1,7	3	4	3,1	4,2	0,055	0,09	0,13
1,3	1,7	1,4	1,9	3,2	4,2	3,3	4,6	0,06	0,1	0,15
1,4	2	1,5	2,2	3,5	4,5	3,6	5	0,07	0,1	0,16
1,6	2,2	1,7	2,4	4	5,5	4,2	5,7	0,08	0,12	0,18
1,7	2,4	1,8	2,6	4,2	6	4,6	6,2	0,09	0,13	0,2
1,9	2,6	2	2,9	4,7	6,7	4,8	6,9	0,1	0,14	0,22
2	3	2,2	3,2	5	7,5	5,2	7,7	0,11	0,15	0,24
2,4	3,4	2,6	3,6	6	8,2	6,2	8,4	0,12	0,17	0,26
2,6	3,6	2,9	3,9	6,5	9	5,8	9,2	0,13	0,19	0,29
3,1	4,1	3,4	4,4	7,7	10	8	10,4	0,13	0,2	0,31
3,3	4,4	3,6	4,8	8,2	11	8,4	11,2	0,16	0,23	0,35
3,7	5	4,1	5,4	9,2	12,5	9,6	12,8	0,17	0,25	0,36
4	5,4	4,4	5,9	10	13,5	10,4	14	0,2	0,29	0,41
4,6	6,2	5,1	6,8	11,5	15,5	12	16	0,21	0,31	0,45
5,3	7	5,8	7,6	13,3	17,5	13,6	18	0,23	0,35	0,51
5,7	7,8	6,3	8,5	14,3	19,5	14,8	20	0,27	0,39	0,57
6,3	8,5	7	9,4	15,8	21	16,4	22	0,3	0,43	0,64
6,8	9	7,6	10,2	17	23	18	24	0,32	0,48	0,7
7,4	9,8	8,3	11	18,5	25	19,6	26	0,34	0,54	0,77
8,3	10,8	9,3	12,1	21	27	22,2	28,3	0,36	0,59	0,84

Spherical Roller Bearing

DATA TABLE

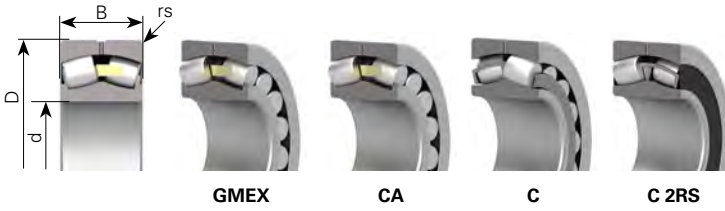

Part number	Principal dimensions			Basic load ratings			Speed limits		Radius rs min.	Weight	Calculation factors			
	Bore	Outer	Width	Dynamic	Static	Fatigue	Grease	Oil			e	Y1	Y2	Yo
	d	D	B	Cr	Cor	Pu	rpm		mm	Kg				
	mm			kN			1 min ⁻¹							
22205 GMEX	25	52	18	46,2	49,0	6,0	11050	14450	1	0,196	0,35	1,95	2,90	1,91
22206 GMEX	30	62	20	60,8	61,9	7,6	8500	11900	1	0,296	0,33	2,03	3,02	1,98
22207 GMEX	35	72	23	83,5	83,2	10,1	7650	10200	1,1	0,443	0,34	2,00	2,98	1,96
21307 GMEX	35	80	21	78,5	81,2	9,9	5695	8075	1,5	0,538	0,27	2,53	3,77	2,47
22208 GMEX	40	80	23	90,3	99,9	12,2	6800	9350	1,1	0,532	0,29	2,35	3,50	2,30
21308 GMEX	40	90	23	103,0	104,9	12,8	5950	8075	1,5	0,736	0,27	2,51	3,74	2,45
22308 GMEX	40	90	33	140,4	146,1	17,8	5100	6800	1,5	1,049	0,39	1,75	2,61	1,71
22308 C 2RS	40	90	38	115,0	127,0	15,5	5300		1,5	1,07	0,38	1,80	2,70	1,80
22209 GMEX	45	85	23	99,2	107,7	13,1	6375	8500	1,1	0,567	0,26	2,57	3,82	2,51
21309 GMEX	45	100	25	131,0	131,3	16,0	5355	7225	1,5	0,986	0,27	2,51	3,74	2,45
22309 GMEX	45	100	36	170,9	179,0	21,8	4505	5950	1,5	1,425	0,38	1,77	2,64	1,73
22309 C 2RS	45	100	42	146,0	168,0	20,5	4800		1,5	1,43	0,37	1,80	2,70	1,80
22210 GMEX	50	90	23	102,0	114,3	13,9	5950	8075	1,1	0,622	0,24	2,77	4,12	2,70
21310 GMEX	50	110	27	143,0	150,2	18,3	4760	6370	2	1,32	0,25	2,67	3,97	2,61
22310 GMEX	50	110	40	220,0	238,0	29,0	4080	5355	2	1,88	0,37	1,84	2,74	1,80
22310 C 2RS	50	110	45	181,0	208,0	25,4	4600		2	1,87	0,38	1,80	2,70	1,80
22211 GMEX	55	100	25	123,0	138,3	16,9	5355	7225	1,5	0,862	0,24	2,79	4,15	2,73
21311 GMEX	55	120	29	155,0	173,0	21,1	4760	6375	2	1,63	0,25	2,74	4,08	2,68
22311 GMEX	55	120	43	258,0	268,3	32,7	3655	4760	2	2,386	0,37	1,80	2,69	1,76
22311 C 2RS	55	120	49	213,0	248,0	30,2	4000		2	2,485	0,37	1,90	2,80	1,80
22212 GMEX	60	110	28	140,0	167,4	20,4	4760	6375	1,5	1,166	0,24	2,78	4,13	2,71
21312 GMEX	60	130	31	200,7	222,5	27,1	4080	5355	2,1	2,07	0,24	2,76	4,11	2,70
22312 GMEX	60	130	46	290,0	313,5	38,2	3400	4500	2,1	2,929	0,37	1,85	2,75	1,76
22312 C 2RS	60	130	53	243,0	284,0	34,6	3800		2,1	2,768	0,36	1,90	2,80	1,80
22213 GMEX	65	120	31	188,0	224,0	27,3	4250	5950	1,5	1,57	0,25	2,69	4,00	2,63
21313 GMEX	65	140	33	219,6	254,1	30,8	3655	5100	2,1	2,49	0,24	2,85	4,25	2,79
22313 GMEX	65	140	48	336,0	368,4	44,6	3230	4250	2,1	3,622	0,35	1,95	2,90	1,91
22313 C 2RS	65	140	53	251,0	291,0	35,2	3600		2,1	3,78	0,35	1,90	2,90	1,90
22214 GMEX	70	125	31	191,0	234,1	28,5	4250	5695	1,5	1,65	0,23	2,90	4,31	2,83
21314 GMEX	70	150	35	253,4	296,4	35,1	3400	4760	2,1	3,19	0,23	2,88	4,29	2,82
22314 GMEX	70	150	51	385,0	442,0	52,4	2890	3825	2,1	4,44	0,34	1,99	2,96	1,94
22314 C 2RS	70	150	60	300,0	362,0	42,9	3600		2,1	4,37	0,34	2,00	2,90	1,90
22215 GMEX	75	130	31	206,0	238,0	28,8	4080	5355	1,5	1,73	0,22	3,04	4,53	2,97
21315 GMEX	75	160	37	275,0	322,0	37,4	3400	4760	2,1	3,64	0,23	2,90	4,31	2,83
22315 GMEX	75	160	55	422,0	456,0	53,0	2200	3000	2,1	5,539	0,38	1,78	2,65	1,74

Spherical Roller Bearing

DATA TABLE



Part number	Principal dimensions			Basic load ratings			Speed limits		Radius rs min.	Weight	Calculation factors			
	Bore	Outer	Width	Dynamic	Static	Fatigue	Grease	Oil			e	Y1	Y2	Yo
	d	D	B	Cr	Cor	Pu	rpm	mm	Kg	mm				
mm			kN			1 min ⁻¹								
22315 C 2RS	75	160	64	351,0	437,0	50,8	3000		2,1	5,64	0,35	2,00	2,90	1,90
22316 GMEX	80	140	33	229,2	274,2	32,5	3655	5100	2	2,14	0,22	3,07	4,57	3,00
21316 GMEX	80	170	39	310,0	375,5	42,8	3230	4505	2,1	4,3	0,23	2,92	4,35	2,86
22316 GMEX	80	170	58	476,0	557	63,5	2550	3400	2,1	6,55	0,35	1,92	2,86	1,88
22316 C 2RS	80	170	67	395,0	496,0	56,6	2800		2,1	6,536	0,34	2,00	2,90	1,90
22217 GMEX	85	150	36	265,0	316,0	36,7	3400	4760	2	2,72	0,22	3,01	4,48	2,94
21317 GMEX	85	180	41	337,4	387,3	43,4	3230	4505	3	5,05	0,23	2,96	4,41	2,90
22317 GMEX	85	180	60	530,0	591,4	66,3	2500	3000	3	8,19	0,34	2,01	3,00	1,97
22317 C 2RS	85	180	60	431,0	539,0	60,4	2500		3	7,403	0,34	2,00	3,00	2,00
22218 GMEX	90	160	40	318,0	399,5	45,6	3230	4505	2	3,48	0,24	2,87	4,27	2,80
23218 CA	90	160	52,4	316,0	453,0	51,7	1600	2200	2	4,64	0,33	2,07	3,09	2,03
21318 GMEX	90	190	43	386,0	435,2	48,0	3060	4080	3	5,92	0,23	2,97	4,42	2,90
22318 GMEX	90	190	64	570	677	74,6	2300	2700	3	8,33	0,34	2,00	2,97	1,95
22318 C 2RS	90	190	64	497,0	659,0	72,6	2600		3	8,634	0,34	2,00	3,00	2,00
22219 GMEX	95	170	43	360,0	420,0	47,1	3060	4080	2,1	4,22	0,24	2,81	4,18	2,75
21319 GMEX	95	200	45	430,0	502	54,5	2890	3825	3	6,93	0,22	3,04	4,52	2,97
22319 GMEX	95	200	67	636	745	80,8	2100	2500	3	10,5	0,34	2,00	2,99	1,96
22319 C 2RS	95	200	67	531	705	76,5	2200		3	9,967	0,34	2,00	3,00	2,00
23020 GMEX	100	150	37	239,0	370,1	42,2	2000	2600	1,5	2,51	0,22	3,07	4,56	3,00
24020 CA	100	150	50	242,0	425,0	48,5	1500	2000	1,5	3,15	0,30	2,23	3,32	2,18
23120 GMEX	100	165	52	379,0	547	61,3	1500	2000	2	4,42	0,29	2,30	3,42	2,25
22220 GMEX	100	180	46	399,0	508	56,0	2890	3825	2,1	5,11	0,24	2,80	4,18	2,74
23220 CA	100	180	60,3	405,0	589	64,9	1500	1900	2,1	6,81	0,33	2,03	3,02	1,98
21320 GMEX	100	215	47	437,7	510	54,3	2890	3825	3	8,36	0,22	3,06	4,56	2,99
22320 GMEX	100	215	73	701	876	93,2	1900	2200	3	13,8	0,34	1,97	2,93	1,93
23022 GMEX	110	170	45	327,9	520	57,3	1900	2500	2	3,54	0,24	2,84	4,23	2,78
24022 CA	110	170	60	294,0	506	55,8	1300	1800	2	5,6	0,32	2,12	3,15	2,07
23122 GMEX	110	180	56	417,1	631	68,9	1300	1700	2	5,73	0,29	2,32	3,45	2,26
24122 CA	110	180	69	462,0	758	82,7	1200	1500	2	6,85	0,37	1,84	2,74	1,80
22222 GMEX	110	200	53	510	651	69,6	2200	3000	2,1	7,23	0,25	2,66	3,97	2,60
23222 CA	110	200	69,8	565	836	89,4	1300	1800	2,1	9,79	0,34	2,00	2,97	1,95
22322 GMEX	110	240	80	895	998	102,9	1800	2000	3	18,9	0,35	1,95	2,90	1,91
22322 C 2RS	110	240	80	545	832	85,8	1800		3	17,4	0,35	2,00	3,00	2,00
23024 GMEX	120	180	46	340,8	549	59,3	1700	2300	2	4,44	0,21	3,20	4,77	3,13
24024 CA	120	180	60	386,0	673	72,7	1200	1700	2	5,4	0,31	2,18	3,24	2,13

Spherical Roller Bearing

DATA TABLE

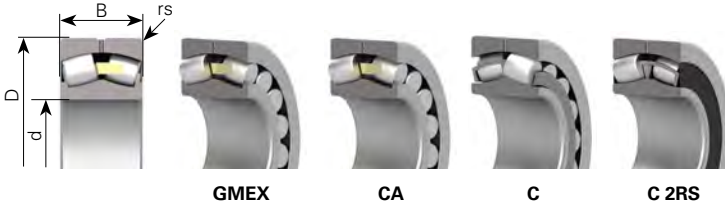

Part number	Principal dimensions			Basic load ratings			Speed limits		Radius rs min.	Weight	Calculation factors			
	Bore	Outer	Width	Dynamic	Static	Fatigue	Grease	Oil			e	Y1	Y2	Yo
	d	D	B	Cr	Cor	Pu	rpm	mm	Kg	mm				
23124 GMEX	120	200	62	545	785	83,1	1250	1600	2	12,4	0,29	2,35	3,50	2,30
24124 CA	120	200	80	601	994	105,3	1100	1400	2	10,2	0,39	1,74	2,59	1,70
22224 GMEX	120	215	58	583	766	80,0	2100	2800	2,1	9,87	0,27	2,49	3,71	2,43
23224 CA	120	215	76	592	904	94,4	1200	1600	2,1	12,1	0,34	1,98	2,94	1,93
22324 GMEX	120	260	86	981	1217	122,4	1500	1900	3	23,3	0,34	2,01	3,00	1,97
23026 GMEX	130	200	52	438,0	709	74,40	1600	2100	2	7,04	0,23	2,87	4,28	2,81
24026 CA	130	200	69	484,0	841	88,3	1100	1500	2	8,16	0,33	2,07	3,09	2,03
23126 GMEX	130	210	64	586	842	87,5	1200	1500	2	10,7	0,28	2,37	3,53	2,32
24126 CA	130	210	80	597	1020	106,1	980	1300	2	11,1	0,36	1,87	2,79	1,83
22226 GMEX	130	230	64	660	919	94,0	2000	2600	3	11,25	0,26	2,55	3,80	2,50
23226 CA	130	230	80	734	1094	111,8	1100	1500	3	14,3	0,34	1,99	2,96	1,94
22326 GMEX	130	280	93	1170	1465	144,1	1300	1800	4	18,3	0,33	2,02	3,01	1,98
22326 C 2RS	130	280	93	965	1341	131,9	1600		4	28	0,34	2,00	3,00	2,00
23028 GMEX	140	210	53	465,2	761	78,5	1500	1900	2	6,70	0,23	2,95	4,39	2,89
24028 CA	140	210	69	495,0	865	89,2	1100	1400	2	8,42	0,31	2,21	3,29	2,16
23128 GMEX	140	225	68	665	976	99,3	1100	1400	2,1	10,9	0,28	2,43	3,61	2,37
24128 CA	140	225	85	634	1100	112,0	920	1200	2,1	13,1	0,35	1,94	2,88	1,89
22228 GMEX	140	250	68	725	997	99,5	1900	2200	3	14,23	0,27	2,49	3,71	2,43
23228 C	140	250	88	960	1500	149,7	1900	2200	3	18,5	0,38	1,78	2,64	1,80
23228 CA	140	250	88	818	1230	122,8	1000	1400	3	18,9	0,35	1,92	2,85	1,87
22328 GMEX	140	300	102	1360	1702	163,8	1200	1600	4	36,2	0,35	1,95	2,90	1,91
22328 C 2RS	140	300	102	1130	1600	154,0	1400		4	35,1	0,35	2,00	2,90	1,90
23030 GMEX	150	225	56	515	851	85,91	1400	1800	2,1	8,01	0,24	2,84	4,23	2,78
24030 CA	150	225	75	564	1010	102,0	990	1300	2,1	10,5	0,32	2,12	3,15	2,07
23130 GMEX	150	250	80	860	1312	130,0	1050	1300	2,1	16,5	0,30	2,28	3,39	2,23
24130 CA	150	250	100	891	1520	150,6	840	1100	2,1	19,5	0,39	1,74	2,59	1,70
22230 GMEX	150	270	73	876	1224	119,5	1800	2000	3	18,7	0,27	2,51	3,73	2,45
23230 CA	150	270	96	925	1450	141,5	980	1300	3	24,3	0,36	1,87	2,79	1,83
22330 GMEX	150	320	108	1530	1912	180,4	1100	1500	4	41,5	0,34	1,97	2,94	1,93
22330 C 2RS	150	320	108	1270	1740	164,2	1200		4	42,8	0,37	2,00	3,00	1,90
23032 GMEX	160	240	60	589	980	97,11	1300	1700	2,1	10,0	0,22	3,01	4,48	2,94
24032 CA	160	240	80	655	1180	116,9	930	1200	2,1	13	0,32	2,12	3,15	2,07
23132 GMEX	160	270	86	1040	1464	141,9	1000	1250	2,1	21,9	0,30	2,27	3,38	2,22
24132 CA	160	270	109	1050	1810	175,4	780	1000	2,1	26,1	0,39	1,71	2,54	1,67
22232 GMEX	160	290	80	976	1325	126,7	1700	1800	3	24,1	0,28	2,43	3,61	2,37

Spherical Roller Bearing

DATA TABLE



Part number	Principal dimensions			Basic load ratings			Speed limits		Radius rs min.	Weight	Calculation factors			
	Bore	Outer	Width	Dynamic	Static	Fatigue	Grease	Oil			e	Y1	Y2	Yo
	d	D	B	Cr	Cor	Pu	rpm		Kg	mm				
	mm			kN			1 min ⁻¹			mm				
23232 CA	160	290	104	1050	1670	159,7	910	1200	3	31,7	0,36	1,87	2,79	1,83
22332 GMEX	160	340	114	1552	2101	194,7	1050	1400	4	52,8	0,34	1,97	2,94	1,93
23034 GMEX	170	260	67	705	1187	115,1	1200	1600	2,1	14,1	0,23	2,91	4,34	2,85
24034 CA	170	260	90	800	1470	142,5	860	1200	2,1	17,6	0,33	2,07	3,09	2,03
23134 GMEX	170	280	88	1072	1655	158,2	950	1200	2,1	26,1	0,30	2,26	3,37	2,21
24134 CA	170	280	109	1080	1870	178,8	740	990	2,1	26,4	0,37	1,83	2,72	1,79
22234 GMEX	170	310	86	1023	1495	140,2	1300	1600	4	26,8	0,27	2,54	3,78	2,48
23234 CA	170	310	110	1230	1970	184,8	840	1100	4	35,8	0,34	1,99	2,96	1,94
22334 GMEX	170	360	120	1750	2228	202,8	980	1300	4	62,6	0,34	1,99	2,97	1,95
22324 C 2RS	170	260	86	848	1129	109,4	1700		3	22,5	0,34	2,00	3,00	2,00
23936 CA	180	250	52	473,9	858	83,2	1700	2200	2	7,34	0,18	3,80	5,60	3,60
23036 GMEX	180	280	74	886	1364	129,6	1100	1500	2,1	17,7	0,24	2,84	4,23	2,78
24036 CA	180	280	100	936	1710	162,4	810	1100	2,1	23,5	0,34	1,99	2,96	1,94
23136 GMEX	180	300	96	1280	1967	184,5	880	1100	3	28	0,30	2,25	3,35	2,20
24136 CA	180	300	118	1240	2180	204,4	700	930	3	32,56	0,38	1,77	2,64	1,73
22236 GMEX	180	320	86	1180	1591	147,4	1300	1500	4	28,75	0,26	2,64	3,93	2,58
23236 CA	180	320	112	1270	2050	189,9	820	1100	4	39,5	0,35	1,94	2,88	1,89
22336 GMEX	180	380	126	2050	2646	236,9	930	1200	4	72,2	0,34	2,00	2,97	1,95
23038 GMEX	190	290	75	845	1420	133,2	1050	1400	2,1	17,3	0,24	2,84	4,23	2,78
24038 CA	190	290	100	931	1800	168,8	780	1000	2,1	23,8	0,33	2,07	3,09	2,03
23138 GMEX	190	320	104	1450	2121	195,3	800	1000	3	34,3	0,31	2,21	3,29	2,16
24138 CA	190	320	128	1330	2340	215,5	650	870	3	41,5	0,37	1,82	2,71	1,78
22238 GMEX	190	340	92	1292	1420	129,3	1200	1500	4	37,4	0,26	2,62	3,90	2,56
23238 CA	190	340	120	1420	2340	213,0	760	1000	4	48,0	0,33	2,03	3,03	1,99
23238 GMEX	190	340	120	1645	2560	233,1	780	1050	4	44,8	0,34	1,99	2,96	1,94
22338 GMEX	190	400	132	2160	2860	252,1	880	1100	5	82,2	0,35	1,95	2,90	1,91
23040 GMEX	200	310	82	1100	1750	161,2	1000	1300	2,1	23,5	0,24	2,83	4,22	2,77
24040 CA	200	310	109	1170	2170	199,8	730	970	2,1	31,4	0,33	2,03	3,02	1,98
23140 GMEX	200	340	112	1536	2547	230,6	750	950	3	40,8	0,31	2,19	3,26	2,14
24140 CA	200	340	140	1732	2920	264,3	620	830	3	53,3	0,40	1,68	2,50	1,64
23240 CA	200	360	128	1580	2620	234,6	730	970	4	57,8	0,36	1,90	2,83	1,86
22340 GMEX	200	420	138	2440	3137	272,5	800	1000	5	97	0,35	1,95	2,90	1,91
23044 GMEX	220	340	90	1192	2095	187,6	950	1200	3	31	0,24	2,84	4,23	2,78
24044 CA	220	340	118	1370	2550	228,3	660	880	3	40,5	0,33	2,07	3,09	2,03

Spherical Roller Bearing

DATA TABLE

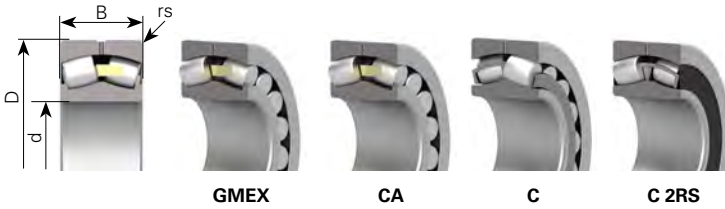

Part number	Principal dimensions			Basic load ratings			Speed limits		Radius rs min.	Weight	Calculation factors			
	Bore	Outer	Width	Dynamic	Static	Fatigue	Grease	Oil			e	Y1	Y2	Yo
	d	D	B	Cr	Cor	Pu	rpm		mm	Kg				
23144 GMEX	220	370	120	1768	2993	263,8	700	900	4	52	0,30	2,24	3,34	2,19
24144 CA	220	370	150	1870	3390	298,8	570	750	4	67,5	0,39	1,71	2,54	1,67
22244 GMEX	220	400	108	1800	2560	222,3	1000	1300	4	58,75	0,26	2,61	3,88	2,55
23244 CA	220	400	144	1960	3270	284,0	660	880	4	80,6	0,36	1,87	2,79	1,83
22344 GMEX	220	460	145	2810	3651	308,4	730	900	5	119	0,33	2,06	3,07	2,02
23048 GMEX	240	360	92	1350	2203	193,2	870	1150	3	34	0,23	2,94	4,38	2,88
24048 CA	240	360	118	1400	2680	235,1	620	830	3	43,6	0,31	2,21	3,29	2,16
23148 GMEX	240	400	128	2195	3470	298,5	670	800	4	66	0,30	2,27	3,38	2,22
24148 CA	240	400	160	2110	3880	333,8	520	700	4	83,8	0,39	1,74	2,59	1,70
22248 GMEX	240	440	120	2330	3310	279,6	900	1100	4	83	0,26	2,55	3,80	2,50
23248 CA	240	440	160	2520	3950	333,7	670	850	4	102	0,35	1,90	2,90	1,80
23952 CA	260	360	75	902	1750	152,0	1100	1500	2,1	21,6	0,18	3,80	5,60	3,60
23052 GMEX	260	400	104	1562	2678	228,3	850	1100	4	49,5	0,25	2,69	4,00	2,63
24052 CA	260	400	140	1800	3500	298,3	700	900	4	66,7	0,33	2,00	3,00	2,00
23152 CA	260	440	144	2250	3900	326,6	800	1000	4	87,5	0,31	2,20	3,30	2,20
24152 CA	260	440	180	2100	4350	364,3	430	530	4	115	0,39	1,73	2,58	1,69
22252 CA	260	480	130	2280	3600	296,5	850	1100	5	106	0,27	2,51	3,74	2,45
23252 CA	260	480	174	2800	4750	391,2	630	800	5	141	0,35	1,90	2,90	1,80
22352 CA	260	540	165	3080	4750	382,2	630	800	6	186	0,31	2,20	3,30	2,20
23856 CA	280	350	52	435,0	1230	106,3	800	1000	2	11,4	0,13	5,36	7,98	5,24
23956 CA	280	380	75	910	1980	168,8	1000	1400	2,1	25,7	0,18	3,80	5,66	3,72
23056 CA	280	420	106	1450	2850	238,7	850	1100	4	56,8	0,23	2,91	4,40	2,84
23056 GMEX	280	420	106	1800	3000	251,2	850	1100	4	52,34	0,23	2,91	4,40	2,84
24056 CA	280	420	140	1780	3700	309,9	670	850	4	69,2	0,31	2,20	3,30	2,20
23156 CA	280	460	146	2190	4150	341,8	750	950	5	104	0,30	2,30	3,40	2,20
24156 CA	280	460	180	2530	4750	391,2	400	500	5	119	0,40	1,70	2,50	1,60
22256 CA	280	500	130	2320	3590	291,0	810	1100	5	117,2	0,26	2,60	3,87	2,54
23256 CA	280	500	176	2840	5100	413,5	600	750	5	147	0,35	1,90	2,90	1,80
22356 CA	280	580	175	3520	5700	448,8	600	750	6	221	0,30	2,30	3,40	2,20
23860 CA	300	380	60	640	1650	139,4	950	1400	3	18,2	0,13	5,20	7,70	5,00
23960 CA	300	420	90	1050	2500	207,6	950	1300	3	40,1	0,19	3,60	5,30	3,60
23060 CA	300	460	118	2037	3806	310,9	800	1000	4	75,8	0,23	2,90	4,40	2,80
24060 CA	300	460	160	2320	4940	403,6	600	750	4	99	0,32	2,09	3,11	2,04
23160 CA	300	500	160	2800	5100	410,3	670	850	5	125	0,30	2,30	3,40	2,20
24160 CA	300	500	200	3100	6000	482,7	600	750	5	161	0,39	1,75	2,61	1,71

Spherical Roller Bearing

DATA TABLE



Part number	Principal dimensions			Basic load ratings			Speed limits		Radius rs min.	Weight	Calculation factors			
	Bore	Outer	Width	Dynamic	Static	Fatigue	Grease	Oil			e	Y1	Y2	Yo
	d	D	B	Cr	Cor	Pu	rpm	mm	Kg	mm				
mm			kN			1 min ⁻¹								
22260 CA	300	540	140	2620	4300	340,9	750	950	5	138	0,26	2,60	3,90	2,50
23260 CA	300	540	192	3632	5978	474,0	530	670	5	192	0,35	1,90	2,90	1,80
23864 CA	320	400	60	670	1620	134,5	920	1280	2,1	20,3	0,12	5,60	8,40	5,60
23964 CA	320	440	90	1200	2650	216,5	900	1200	3	42,7	0,18	3,80	5,60	3,60
23064 CA	320	480	121	2120	3913	314,8	800	1000	4	84,8	0,23	2,90	4,40	2,80
24064 CA	320	480	160	2480	5100	410,3	560	700	4	105	0,32	2,09	3,11	2,04
23164 CA	320	540	176	3250	6004	472,7	630	800	5	200	0,31	2,20	3,30	2,20
24164 CA	320	540	218	3560	6500	512	340	430	5	206	0,40	1,70	2,50	1,60
22264 CA	320	580	150	3000	4550	353,4	670	850	5	175	0,26	2,60	3,90	2,50
23264 CA	320	580	208	3900	6800	528	500	630	5	253	0,35	1,90	2,90	1,80
23968 CA	340	460	90	1200	2700	217,2	900	1200	3	46	0,17	4,00	5,90	4,00
23068 CA	340	520	133	1980	4400	346,4	700	900	5	115	0,24	2,84	4,23	2,78
24068 CA	340	520	180	3000	6100	480,3	530	670	5	137	0,32	2,12	3,15	2,07
23168 CA	340	580	190	3650	6700	517	600	750	5	182	0,31	2,20	3,30	2,20
24168 CA	340	580	243	4400	7950	613,4	320	400	5	256	0,40	1,70	2,50	1,60
23268 CA	340	620	224	4400	7700	586,5	430	530	6	297	0,35	1,90	2,90	1,80
23972 CA	360	480	90	1290	2820	223,6	850	1100	3	46,6	0,16	4,20	6,30	4,00
23072 CA	360	540	134	2280	4800	372,8	670	850	5	126	0,23	2,90	4,40	2,80
24072 CA	360	540	180	2820	6100	473,8	600	750	5	150	0,31	2,20	3,30	2,20
23172 CA	360	600	192	3750	7000	533	560	700	5	255	0,30	2,30	3,40	2,20
24172 CA	360	600	243	5600	8400	640	300	380	5	270	0,37	1,80	2,70	1,80
22272 CA	360	650	170	3630	6200	465,1	380	480	6	253	0,26	2,60	3,87	2,54
23272 CA	360	650	232	4650	8300	623	400	500	6	335	0,35	1,90	2,90	1,80
22372 CA	360	750	224	4900	8600	627	400	500	7,5	460	0,31	2,21	3,29	2,16
23976 CA	380	520	106	1847	4039	313,7	800	1000	4	69,5	0,17	4,00	5,90	4,00
23076 CA	380	560	135	2480	5000	383,3	630	800	5	130	0,22	3,00	4,60	2,80
24076 CA	380	560	180	3150	6900	529	480	600	5	150	0,30	2,30	3,40	2,20
23176 CA	380	620	194	3740	7350	553	400	500	5	250	0,30	2,30	3,40	2,20
24176 CA	380	620	243	4400	9200	692	300	380	5	296	0,30	2,30	3,40	2,20
23276 CA	380	680	240	4800	9200	680	380	480	6	386	0,35	1,90	2,90	1,80
23980 CA	400	540	106	1750	3950	302,8	750	950	4	72,4	0,17	4,00	5,90	4,00
23080 CA	400	590	142	2650	5600	422,7	630	800	5	133	0,21	3,14	4,68	3,07
24080 CA	400	600	200	3600	7800	587	450	560	5	202	0,30	2,30	3,40	2,20
23180 CA	400	650	200	4100	7650	567	380	480	6	275	0,28	2,40	3,60	2,50
24180 CA	400	650	250	4800	9600	712	320	400	6	326	0,36	1,87	2,79	1,83

Spherical Roller Bearing

DATA TABLE

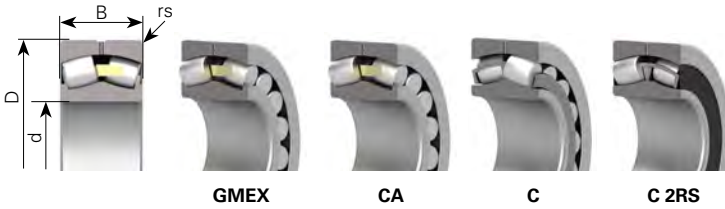

Part number	Principal dimensions			Basic load ratings			Speed limits		Radius rs min.	Weight	Calculation factors			
	Bore	Outer	Width	Dynamic	Static	Fatigue	Grease	Oil			e	Y1	Y2	Yo
	d	D	B	Cr	Cor	Pu	rpm		mm	Kg				
23280 CA	400	720	256	6150	11300	822	340	430	6	350	0,35	1,90	2,90	1,80
23380 CA	400	820	243	6400	9900	702	340	430	7,5	623	0,31	2,21	3,29	2,16
23984 CA	420	560	106	1530	4050	306,6	700	900	4	72,4	0,16	4,20	6,30	4,00
23084 CA	420	620	150	2970	6400	476,0	450	560	5	150	0,22	3,00	4,60	2,80
24084 CA	420	620	200	3690	8450	628	380	480	5	202	0,30	2,30	3,40	2,20
23184 CA	420	700	224	4680	9200	669	360	450	6	353	0,30	2,30	3,40	2,20
24184 CA	420	700	280	5750	11100	807	300	380	6	436	0,38	1,80	2,60	1,70
23284 CA	420	760	272	6170	11900	852	320	400	7,5	550	0,35	1,90	2,90	1,80
23988 CA	440	600	118	2030	4850	360,7	450	560	4	101	0,17	4,00	5,90	4,00
23088 CA	440	650	157	3150	6500	476,6	430	530	6	179	0,22	3,00	4,60	2,80
24088 CA	440	650	212	4150	9100	667	360	450	6	251	0,30	2,30	3,40	2,20
23188 CA	440	720	226	4950	10000	720	340	430	6	378	0,30	2,30	3,40	2,20
24188 CA	440	720	280	7300	13400	964	300	380	6	469	0,37	1,80	2,70	1,80
23288 CA	440	790	280	7600	12300	870	320	400	7,5	612	0,35	1,90	2,90	1,80
24892 CA	460	580	118	1730	4850	360,7	450	560	3	82	0,17	4,00	5,90	4,00
23992 CA	460	620	118	2263	5260	386,8	430	530	4	105	0,16	4,20	6,30	4,00
23092 CA	460	680	163	3280	6950	503	400	500	6	226	0,22	3,00	4,60	2,80
24092 CA	460	680	218	4200	9100	658	340	430	6	304	0,29	2,35	3,50	2,30
23192 CA	460	760	240	5500	10000	709	320	400	7,5	443	0,30	2,30	3,40	2,20
24192 CA	460	760	300	6890	14400	1021	160	200	7,5	461	0,37	1,80	2,70	1,80
23292 CA	460	830	296	7350	13500	941	300	380	7,5	698	0,35	1,90	2,90	1,80
23896 CA	480	600	90	1450	4000	294,1	450	600	3	60,4	0,13	5,36	7,98	5,24
23996 CA	480	650	128	2370	5750	417,1	400	500	5	126	0,18	3,80	5,60	3,60
23096 CA	480	700	165	3300	6900	494,1	380	480	6	217	0,21	3,20	4,80	3,20
24096 CA	480	700	218	5250	10200	730	340	430	6	296	0,28	2,40	3,60	2,50
23196 CA	480	790	248	6100	12000	840	300	380	7,5	516	0,30	2,30	3,40	2,20
24196 CA	480	790	308	8000	14900	1044	240	320	7,5	584	0,37	1,80	2,70	1,80
23296 CA	480	870	310	7750	15200	1045	260	340	7,5	853	0,35	1,90	2,90	1,80
238/500 CA	500	620	90	1450	3800	276,4	420	520	3	66	0,12	5,60	8,40	5,60
239/500 CA	500	670	128	2530	6000	430,7	400	500	5	120	0,17	4,00	5,90	4,00
230/500 CA	500	720	167	3470	7650	542	380	480	6	228	0,21	3,20	4,80	3,20
240/500 CA	500	720	218	5400	10600	751	420	520	6	306	0,26	2,60	3,90	2,50
231/500 CA	500	830	264	6100	13800	953	320	400	7,5	588	0,30	2,30	3,40	2,20
241/500 CA	500	830	325	9600	16000	1105	300	380	7,5	736	0,37	1,80	2,70	1,80
232/500 CA	500	920	336	9460	18600	1260	280	360	7,5	985	0,35	1,90	2,90	1,80

Spherical Roller Bearing

DATA TABLE



Part number	Principal dimensions			Basic load ratings			Speed limits		Radius rs min.	Weight	Calculation factors			
	Bore	Outer	Width	Dynamic	Static	Fatigue	Grease	Oil			e	Y1	Y2	Yo
	d	D	B	Cr	Cor	Pu	rpm	mm	Kg	mm				
mm			kN			1 min ⁻¹								
238/530 CA	530	650	90	1500	4200	300,7	400	500	3	64,2	0,12	5,60	8,40	5,60
248/530 CA	530	650	118	1820	5280	378,1	380	480	3	91	0,15	4,50	6,70	4,50
239/530 CA	530	710	316	2900	6700	472,7	360	450	5	154	0,17	4,00	5,90	4,00
230/530 CA	530	780	185	4370	9650	670	340	430	6	339	0,22	3,00	4,60	2,80
240/530 CA	530	780	250	5400	12700	881	280	360	6	416	0,29	2,30	3,50	2,40
231/530 CA	530	870	272	8100	13200	898	260	340	7,5	665	0,30	2,30	3,40	2,20
241/530 CA	530	870	335	10300	18700	1272	190	280	7,5	846	0,37	1,80	2,80	1,80
232/530 CA	530	980	335	10300	20300	1350	210	290	9,5	1220	0,36	1,87	2,79	1,83
239/560 CA	560	750	140	3050	7200	500	340	430	5	177	0,16	4,20	6,30	4,00
230/560 CA	560	820	195	4300	10500	717	320	410	6	363	0,22	3,14	4,67	3,07
240/560 CA	560	820	258	5700	13200	902	220	300	6	471	0,28	2,40	3,60	2,50
231/560 CA	560	920	280	7590	15700	1050	240	320	7,5	756	0,30	2,30	3,40	2,20
241/560 CA	560	920	355	10000	20100	1345	120	160	7,5	953	0,37	1,80	2,80	1,80
232/560 CA	560	1030	365	11200	21000	1375	190	260	9,5	1380	0,35	1,90	2,90	1,80
239/600 CA	600	800	150	3640	8420	573	400	530	5	220	0,17	3,97	5,91	4,00
249/600 CA	600	800	200	4070	11200	762	320	400	5	287	0,22	3,00	4,60	2,80
230/600 CA	600	870	200	5170	11600	778	300	380	6	442	0,22	3,00	4,60	2,80
240/600 CA	600	870	272	6800	16000	1073	220	300	6	560	0,30	2,30	3,40	2,80
231/600 CA	600	980	300	8900	18800	1233	180	250	7,5	894	0,29	2,30	3,50	2,40
241/600 CA	600	980	375	10850	22750	1492	220	280	7,5	1200	0,38	1,78	2,64	1,80
232/600 CA	600	1090	388	12500	25000	1607	190	260	9,5	1568	0,35	1,93	2,88	1,80
238/630 CA	630	780	112	2200	6300	428	300	380	4	124	0,12	5,60	8,40	5,60
239/630 CA	630	850	165	3550	9750	652	280	360	6	280	0,17	4,00	5,90	4,00
230/630 CA	630	920	212	5670	12800	845	260	340	7,5	471	0,21	3,20	4,80	3,20
231/630 CA	630	1030	315	10000	21000	1357	180	250	7,5	1080	0,30	2,30	3,40	2,20
241/630 CA	630	1030	400	12500	27200	1758	160	210	7,5	1440	0,37	1,80	2,70	1,80
238/670 CA	670	820	112	2210	6300	420,6	270	350	4	136	0,11	6,10	9,10	6,30
230/670 CA	670	980	230	6580	14400	932	340	450	7,5	600	0,21	3,21	4,79	3,20
231/670 CA	670	1090	336	11000	22500	1429	175	240	7,5	1280	0,30	2,30	3,40	2,20
241/670 CA	670	1090	412	14000	31500	2001	150	190	7,5	1560	0,36	1,87	2,79	1,83
232/670 CA	670	1220	438	15000	32000	1989	160	210	12	2300	0,35	1,90	2,90	1,80
238/710 CA	710	870	118	2680	7550	495,3	260	340	4	156	0,11	6,10	9,10	6,30
239/710 CA	710	950	180	5000	12000	776	240	310	6	364	0,17	4,00	5,90	4,00
249/710 CA	710	950	243	6200	17000	1099	200	280	6	500	0,22	3,00	4,60	2,80
240/710 CA	710	1030	315	8970	21700	1383	240	320	7,5	895	0,27	2,50	3,72	2,50

Spherical Roller Bearing

DATA TABLE

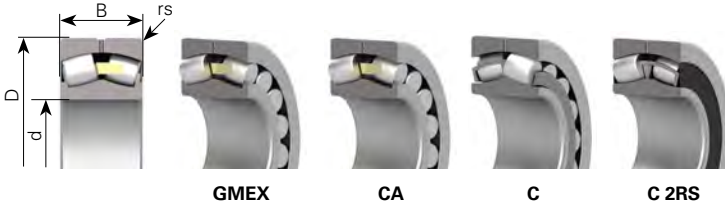

Part number	Principal dimensions			Basic load ratings			Speed limits		Radius rs min.	Weight	Calculation factors			
	Bore	Outer	Width	Dynamic	Static	Fatigue	Grease	Oil			e	Y1	Y2	Yo
	d	D	B	Cr	Cor	Pu	rpm		mm	mm				
231/710 CA	710	1150	345	12000	25800	1612	170	220	9,8	1480	0,28	2,40	3,60	2,50
241/710 CA	710	1150	438	11900	29700	1855	90	120	9,5	1791	0,35	1,90	2,90	1,80
232/710 CA	710	1280	450	17500	34400	2106	160	210	12	2640	0,35	1,90	2,90	1,80
238/750 CA	750	920	128	2950	8600	555	240	310	5	188	0,11	6,10	9,10	6,30
239/750 CA	750	1000	185	5800	13500	859	210	290	6	426	0,16	4,20	6,30	4,00
249/750 CA	750	1000	250	7600	18200	1158	180	250	6	566	0,22	3,00	4,60	2,80
230/750 CA	750	1090	250	7000	17900	1122	200	280	7,5	789	0,21	3,20	4,80	3,20
240/750 CA	750	1090	335	10000	24800	1554	170	220	7,5	1100	0,28	2,40	3,60	2,50
231/750 CA	750	1220	365	13500	28800	1768	160	210	9,5	1760	0,28	2,40	3,60	2,50
241/750 CA	750	1220	475	16000	37000	2272	130	170	9,5	2195	0,35	1,90	2,90	1,80
232/750 CA	750	1360	475	16390	36000	2165	90	120	15	3100	0,36	1,87	2,79	1,83
248/800 CA	800	980	180	4150	13000	823	170	220	5	330	0,15	4,50	6,70	4,50
239/800 CA	800	1060	195	6350	14200	887	190	270	6	480	0,16	4,20	6,30	4,00
249/800 CA	800	1060	258	7800	19500	1218	175	240	6	648	0,21	3,20	4,80	3,20
230/800 CA	800	1150	258	8090	19100	1176	170	220	7,5	894	0,20	3,40	5,00	3,20
240/800 CA	800	1150	345	11305	27145	1672	220	280	7,5	1200	0,27	2,50	3,72	2,50
231/800 CA	800	1280	375	14500	31000	1873	150	190	9,5	1960	0,28	2,40	3,60	2,50
241/800 CA	800	1280	475	16300	37100	2241	130	170	9,5	2350	0,35	1,90	2,90	1,80
238/850 CA	850	1030	136	3300	9800	610	180	250	5	244	0,11	6,10	9,10	6,30
239/850 CA	850	1120	200	6450	15880	975	280	380	6	560	0,17	3,97	5,91	4,00
249/850 CA	850	1120	272	8200	22500	1381	170	220	6	750	0,22	3,00	4,60	2,80
230/850 CA	850	1220	272	8450	22500	1361	180	240	7,5	1074	0,20	3,40	5,00	3,20
240/850 CA	850	1220	365	12000	29500	1785	220	280	7,5	1410	0,27	2,50	3,72	2,50
231/850 CA	850	1360	400	16000	34200	2029	130	170	12	2260	0,28	2,40	3,60	2,50
241/850 CA	850	1360	500	20000	45100	2675	105	140	12	2750	0,35	1,90	2,90	1,80
248/900 CA	900	1090	190	4890	15500	949	210	375	5	370	0,14	4,80	7,20	4,50
239/900 CA	900	1180	206	6930	17120	1034	280	360	6	605	0,15	4,50	6,70	4,50
230/900 CA	900	1280	280	10200	23500	1400	160	210	7,5	1220	0,20	3,40	5,00	3,20
240/900 CA	900	1280	375	13000	34200	2037	140	190	7,5	1600	0,26	2,60	3,90	2,50
240/900 CA	900	1280	375	14400	35500	2114	200	260	7,5	1570	0,27	2,50	3,72	2,50
241/900 CA	900	1420	515	21000	48500	2835	95	140	12	3400	0,35	1,90	2,90	1,80
239/950 CA	950	1250	224	7350	19000	1129	160	225	7,5	759	0,15	4,50	6,70	4,50
249/950 CA	950	1250	300	9300	25500	1515	135	180	7,5	1030	0,21	3,20	4,80	3,20
230/950 CA	950	1360	300	11000	26800	1569	150	210	7,5	1440	0,20	3,40	5,00	3,20
240/950 CA	950	1360	412	15000	38500	2254	125	160	7,5	2100	0,27	2,50	3,70	2,50

Spherical Roller Bearing

DATA TABLE



Part number	Principal dimensions			Basic load ratings			Speed limits		Radius rs min.	Weight	Calculation factors			
	Bore	Outer	Width	Dynamic	Static	Fatigue	Grease	Oil			Kg	e	Y1	Y2
	d	D	B	Cr	Cor	Pu	rpm		mm	mm				
	mm			kN			1 min ⁻¹							
241/950 CA	950	1500	545	24000	54500	3134	90	125	7,5	3600	0,35	1,90	2,90	1,80
238/1000 CA	1000	1220	165	4400	13600	806	125	160	6	402	0,11	5,92	8,81	5,78
249/1000 CA	1000	1320	315	10200	29200	1707	125	160	7,5	1220	0,21	3,20	4,80	3,20
230/1000 CA	1000	1420	308	12700	30500	1761	130	175	7,5	1590	0,19	3,60	5,30	3,60
240/1000 CA	1000	1420	412	15200	40500	2338	110	150	7,5	2130	0,26	2,60	3,90	2,50
231/1000 CA	1000	1580	462	21500	48200	2729	95	130	12	3520	0,28	2,40	3,50	2,50
241/1000 CA	1000	1580	580	26500	62200	3522	85	110	12	4350	0,35	1,90	2,90	1,80
238/1060 CA	1060	1280	165	4700	14800	863	150	195	6	440	0,11	6,10	9,10	6,30
248/1060 CA	1060	1280	218	6000	19500	1137	125	160	6	576	0,14	4,80	7,20	4,50
239/1060 CA	1060	1400	250	9350	25000	1436	145	170	7,5	1041	0,16	4,20	6,30	4,00
249/1060 CA	1060	1400	335	11000	32600	1873	115	150	7,5	1420	0,21	3,20	4,80	3,20
230/1060 CA	1060	1500	325	13500	33000	1873	125	160	9,5	2300	0,19	3,60	5,30	3,60
240/1060 CA	1060	1500	438	17000	46000	2611	100	145	9,5	2530	0,26	2,60	3,90	2,50
248/1120 CA	1120	1360	243	7150	23500	1347	105	165	6	740	0,15	4,50	6,70	4,50
249/1120 CA	1120	1460	335	12000	35200	1993	90	135	7,5	1500	0,20	3,40	5,00	3,20
230/1120 CA	1120	1580	345	15000	38100	2128	90	125	9,5	2210	0,19	3,40	5,00	3,20
240/1120 CA	1120	1580	462	18100	49500	2765	90	125	9,5	2940	0,26	2,60	3,90	2,50
238/1180 CA	1180	1420	180	5600	18000	1017	150	190	6	577	0,11	6,28	9,35	6,14
248/1180 CA	1180	1420	243	7700	27200	1537	135	160	6	790	0,14	4,80	7,20	4,50
239/1180 CA	1180	1540	272	10290	29600	1650	110	150	7,5	1350	0,16	4,20	6,30	4,00
249/1180 CA	1180	1540	355	13310	40000	2229	110	150	7,5	1772	0,20	3,42	5,09	3,34
230/1180 CA	1180	1660	355	10290	29600	1629	110	150	9,5	2460	0,20	3,42	5,09	3,34
230/1250 CA	1250	1750	375	17500	44800	2425	95	125	9,5	2850	0,19	3,60	5,30	3,60
248/1320 CA	1320	1600	280	9750	33400	1822	85	115	6	1180	0,15	4,50	6,70	4,50
249/1320 CA	1320	1720	400	16000	49200	2652	80	105	7,5	2510	0,21	3,20	4,80	3,20
240/1320 CA	1320	1850	530	23200	63300	3370	70	85	12	4540	0,25	2,70	4,00	2,60
249/1400 CA	1400	1820	425	20000	58500	3100	70	85	9,5	2920	0,20	3,42	5,09	3,34
248/1500 CA	1500	1820	315	12000	40000	2100	65	83	7,5	1730	0,15	4,50	6,70	4,50
248/1800 CA	1800	2180	375	17400	62800	3122	62	70	9,5	2920	0,15	4,50	6,70	4,50
239/950 CAF	950	1250	224	7310	19500	1158	260	340	7,5	755	0,15	4,50	6,70	4,50
240/950 CAF	950	1360	412	15210	39375	2305	180	240	7,5	1990	0,27	2,50	3,72	2,50

TECHNICAL NOTEBOOK

SPHERICAL ROLLER BEARING

VIBRATING SCREEN

ROLLWAY®



In this section:

	Page
Design Characteristics Applications	
Angular Misalignment ISO Specification Series Nomenclature	140
Equivalent Load Equations Radial Clearance Tables	141
Data Tables	142

REGAL®

Spherical Roller Bearing

VIBRATING SCREEN

DESIGN | CHARACTERISTICS | APPLICATIONS

The vibrating screen spherical roller bearing is designed to accommodate vibrating.

The small size bearings have a single piece brass cage, guided on the outer ring raceway (VS).

The large size bearings have a 2 piece brass cage, guided on the outer ring raceway (MA).

These designs improve the cage wear against vibrations.



VS



MA

ANGULAR MISALIGNMENT

The following is an approximate guide to the misalignment that can be accommodated in a vibrating screen spherical roller bearing:

Bearing Series	Permissible angular misalignment degrees
223	2.0

ISO SPECIFICATIONS

- Dimensions in accordance with ISO 15 (latest version)
- Precision class and radial clearance in accordance with the C4F80 table.

SERIES

The vibration screen is only available in 223 series.

NOMENCLATURE

Suffixes:

VS C4 F80 : Vibration screen (d = 40mm - 150mm)

MA C4 F80 : Vibration screen (d = 160mm - 240mm)

W33 : Lubrication groove and 3 lubrication holes on the outside ring



EQUIVALENT LOAD EQUATIONS

Equivalent dynamic load P_e

$$P = F_r + Y_1 F_a \quad \text{when } F_a/F_r \leq e$$

$$P = 0.67 \cdot F_r + Y_2 \cdot F_a \quad \text{when } F_a/F_r > e$$

Values for Y_1 , Y_2 and e are given in the bearing tables.

Equivalent static load P_o

$$P_o = F_r + Y_o F_a$$

Values for Y_o are given in the bearing tables.

C4 F80 CLEARANCE AND PRECISION TABLES

The below table shows the clearance (C4) and tolerances (F80).

Tolerance						Radial Clearance			
Bore			OD						
d	Min.	Max.	D	Min.	Max.	D	Min.	Max.	
40	0	-0,007	90	-0,005	-0,013	40	0,085	0,100	
45			100			45			
50			110			50			
55		-0,009	-0,009	120	-0,018	-0,018	55	0,100	0,120
60				130			60		
65				140			65		
70				150			70		
75				160			75		
80		170	80						
85		-0,012	-0,012	180	-0,010	-0,023	85	0,120	0,145
90				190			90		
95				200			95		
100				215			100		
110				240			110		
120				260			120		
130				280			130		
140		-0,015	-0,015	300	-0,013	-0,028	140	0,150	0,180
150				320			150		
160				340			160		
170	360			170					
180	380			180					
190	-0,018	-0,018	400			190	0,205	0,240	
							0,240	0,280	
							0,260	0,310	
							0,285	0,340	

Spherical Roller Bearing

DATA TABLE - VIBRATING SCREEN

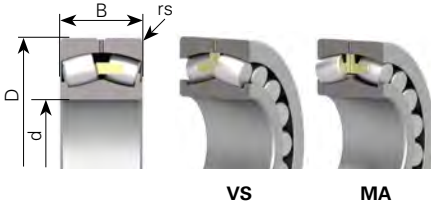

Part number	Principal dimensions			Basic load ratings			Speed limits		Radius rs min.	Weight	Calculation factors			
	Bore	Outer	Width	Dynamic	Static	Fatigue	Grease	Oil			e	Y1	Y2	Yo
	d	D	B	Cr	Cor	Pu	rpm		mm	Kg				
mm			kN			1 min ⁻¹								
22308 VS C4 F80	40	90	33	125,0	135,0	16,5	5300	6300	1,5	1,054	0,39	1,80	2,60	1,70
22309 VS C4 F80	45	100	36	153,0	179,0	21,8	4800	5800	1,5	1,406	0,37	1,80	2,70	1,80
22310 VS C4 F80	50	110	40	193,0	226,0	27,6	4600	5600	2	1,911	0,37	1,80	2,70	1,80
22311 VS C4 F80	55	120	43	226,0	268,0	32,7	4000	4800	2	2,374	0,36	1,90	2,80	1,80
22312 VS C4 F80	60	130	46	262,0	313,0	38,2	3800	4400	2,1	2,942	0,36	1,90	2,80	1,80
22313 VS C4 F80	65	140	48	285,0	330,0	39,9	3600	4200	2,1	3,672	0,35	1,90	2,90	1,90
22314 VS C4 F80	70	150	51	340,0	420,0	49,8	3600	4000	2,1	4,392	0,34	2,00	2,90	1,90
22315 VS C4 F80	75	160	55	380,0	475,0	55,2	3000	3600	2,1	5,352	0,35	2,00	2,90	1,90
22316 VS C4 F80	80	170	58	420,0	535	61,0	2800	3400	2,1	6,411	0,34	2,00	2,90	1,90
22317 VS C4 F80	85	180	60	462,0	591	66,2	2500	3200	3	7,467	0,34	2,00	3,00	2,00
22318 VS C4 F80	90	190	64	588	677	74,6	2600	3000	3	8,563	0,34	2,00	3,00	2,00
22319 VS C4 F80	95	200	67	568	744	80,7	2200	2800	3	10,305	0,34	2,00	3,00	2,00
22320 VS C4 F80	100	215	73	670	880	93,6	2200	2600	3	13,208	0,34	2,00	2,90	1,90
22322 VS C4 F80	110	240	80	800	1060	109,3	1800	2200	3	18,013	0,35	2,00	2,90	1,90
22324 VS C4 F80	120	260	86	930	1230	123,7	1700	2000	3	22,489	0,34	2,00	3,00	2,00
22326 VS C4 F80	130	280	93	1170	1458	143,4	1600	1900	4	27,633	0,33	2,00	3,00	2,00
22328 VS C4 F80	140	300	102	1240	1720	165,6	1400	1500	4	35,918	0,35	2,00	2,90	1,90
22330 VS C4 F80	150	320	108	1400	1940	183,1	1000	1300	4	44,3	0,38	2,00	2,90	1,90
22332 MA C4 F80	160	340	114	1520	2160	200,1	900	1200	4	50,5	0,38	1,78	2,64	1,80
22334 MA C4 F80	170	360	120	1690	2380	216,7	850	1100	4	60,2	0,38	1,78	2,64	1,80
22336 MA C4 F80	180	380	126	1900	2700	241,8	850	1100	4	68,2	0,38	1,78	2,64	1,80
22338 MA C4 F80	190	400	132	1610	2640	232,7	750	1000	4	48,8	0,36	1,90	2,80	1,80

TECHNICAL NOTEBOOK

ROLLWAY®

TAPERED ROLLER BEARING



In this section:

	Page
Design Characteristics Applications Angular Misalignment	
ISO Specification	144
Seriee Nomenclature	145
Equivalent Load Equations.....	145-147
Data Tables	148-154

REGAL®

Tapered Roller Bearing

DESIGN | CHARACTERISTICS | APPLICATIONS

Tapered roller bearings are designed to take radial and thrust loads from one direction. They consist of the inner race (cone) with cage guided rollers and the outer race (cup). The track having the same profile as the tapered rollers. The rollers are guided by contact between the large end of the roller and a large rib on the cone. The extension of the contact lines meet at a common point on the bearing axis of rotation. The cone and cup are separable. By using two bearings as opposed mountings they can carry thrust loadings in both directions.

The bearings are usually mounted in pairs with axial adjustment to provide proper running clearance within the bearings. Being separable, inner and outer rings may be mounted individually.

For heavy thrust loads, the type 30300 with large contact angle is desirable.

Single row tapered roller bearings can be supplied matched in "DB" or "DF" arrangement.

Tapered roller bearings with two and four rows of rollers are used for special steel mill applications.



ANGULAR MISALIGNMENT

The following is an approximate guide to the misalignment that can be prevalent when fitting tapered roller bearings: 2 mins of arc.

ISO SPECIFICATIONS

- Dimensions in accordance with ISO 355 (latest version)
- Precision class in accordance with ISO 492 (latest version)

SERIES

The series below are the most popular:



NOMENCLATURE

Suffixes:

- A : Higher load rating
- X : Dimensional changes
- M : Brass cage. Typically for bore size over 100 mm
- PO-P5 : Precision class

EQUIVALENT LOAD EQUATIONS

Equivalent dynamic load P_e

$$P = F_r \quad \text{where} \quad F_a/F_r \leq e$$

$$P = 0.4 F_r + Y F_a \quad \text{where} \quad F_a/F_r > e$$

For paired single row tapered roller bearings.

$$P = F_r + Y_1 F_a \quad \text{where} \quad F_a/F_r \leq e$$

$$P = 0.67 F_r + Y_2 F_a \quad \text{where} \quad F_a/F_r > e$$

For paired bearings F_r and F_a are the loads acting on the pair.

Since the loads are transmitted from one raceway to the other in an inclined position, radial loads include axial reaction forces, which must be considered when calculating the equivalent dynamic load. For calculation purposes the equations show where bearing A and bearing B are subjected to a radial load F_{rA} and F_{rB} respectively and are always considered positive even when they act in the opposite direction to that shown in the figures. The radial loads act at what is termed the pressure centre of the bearings which is given in the bearing tables as "a" dimension. There is an external force K_a which acts on the shaft or on the housing. Figures 1c and 2c are also valid for $K_a = 0$. The equations are valid only if the bearings have been adjusted against each other to zero clearance and no preload.

Tapered Roller Bearing

Bearing arrangements and load equations

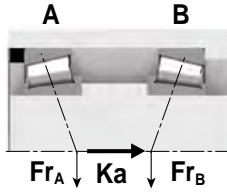
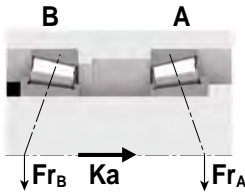

1a)	$\frac{F_{rA}}{Y_A} \geq \frac{F_{rB}}{Y_B}$	$F_{aA} = \frac{0.5F_{rA}}{Y_A}$	$F_{aB} = F_{aA} + K_a$	$K_a \geq 0$
1b)	$\frac{F_{rA}}{Y_A} < \frac{F_{rB}}{Y_B}$	$F_{aA} = \frac{0.5F_{rA}}{Y_A}$	$F_{aB} = F_{aA} + K_a$	$K_a \geq 0.5 \left(\frac{F_{rB}}{Y_B} - \frac{F_{rA}}{Y_A} \right)$
1c)	$\frac{F_{rA}}{Y_A} < \frac{F_{rB}}{Y_B}$	$F_{aA} = F_{aB} - K_a$	$F_{aB} = \frac{0.5F_{rB}}{Y_B}$	$K_a \geq 0.5 \left(\frac{F_{rB}}{Y_B} - \frac{F_{rA}}{Y_A} \right)$

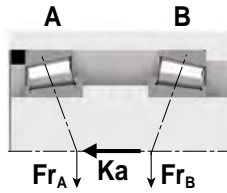
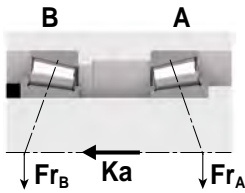

2a)	$\frac{F_{rA}}{Y_A} \leq \frac{F_{rB}}{Y_B}$	$F_{aA} = F_{aB} + K_a$	$F_{aB} = \frac{0.5F_{rB}}{Y_B}$	$K_a \geq 0$
2b)	$\frac{F_{rA}}{Y_A} > \frac{F_{rB}}{Y_B}$	$F_{aA} = F_{aB} + K_a$	$F_{aB} = \frac{0.5F_{rB}}{Y_B}$	$K_a \geq 0.5 \left(\frac{F_{rA}}{Y_A} - \frac{F_{rB}}{Y_B} \right)$
2c)	$\frac{F_{rA}}{Y_A} > \frac{F_{rB}}{Y_B}$	$F_{aA} = \frac{0.5F_{rA}}{Y_A}$	$F_{aB} = F_{aA} - K_a$	$K_a < 0.5 \left(\frac{F_{rA}}{Y_A} - \frac{F_{rB}}{Y_B} \right)$

Equivalent static load P_o

For Single row taper roller bearing

$$P_o = 0.5Fr + Y_oFa \quad \text{where} \quad P_o < = Fr$$

Single row taper roller bearing of paired mounting

$$P_o = Fr + Y_oFa \quad \text{where} \quad P_o < = Fr$$

Coefficients Y_o is listed in the bearing dimension table.

LUBRICATION

Refer to the lubrication chapter (Page No. 340-344) to have more info about the lubrication of tapered roller bearings.

AXIAL CLEARANCE

The axial clearance of single tapered roller bearings is adjusted on assembly.

With matched bearings, as with double and 4 row bearings, axial clearance is achieved by the addition of spacer rings ground to give the required clearance.

Radial clearances fort classes recommended for double and four row tapered roller bearings are shown in the technical section. The radial clearance is transformed into axial clearance by the following relation:

$$\text{Axial clearance} = \frac{\text{Radial clearance}}{2 \tan \alpha}$$

Where: α = contact angle between rollers and the outer ring raceway

d		C1		C2		CN		C3		C4		C5	
mm		min.	max.	min.	max.	min.	max.	min.	max.	min.	max.	min.	max.
50	65	0	15	15	30	30	50	50	70	70	90	90	120
65	80	0	20	20	40	40	60	60	80	80	110	110	150
80	100	0	20	20	45	45	70	70	100	100	130	130	170
100	120	0	25	25	50	50	80	80	110	110	150	150	200
120	140	0	30	30	60	60	90	90	120	120	170	170	230
140	160	0	30	30	65	65	100	100	140	140	190	190	260
160	180	0	35	35	70	70	110	110	150	150	210	210	280
180	200	0	40	40	80	80	120	120	170	170	230	230	310
200	225	0	40	40	90	90	140	140	190	190	260	260	340
225	250	0	50	50	100	100	150	150	210	210	290	290	380
250	280	0	50	50	110	110	170	170	230	230	320	320	420
280	315	0	60	60	120	120	180	180	250	250	350	350	460
315	355	0	70	70	140	140	210	210	280	280	390	390	510
355	400	0	70	70	150	150	230	230	310	310	440	440	580
400	450	0	80	80	170	170	260	260	350	350	490	490	650
450	500	0	90	90	190	190	290	290	390	390	540	540	720
500	560	0	100	100	210	210	320	320	430	430	590	590	790
560	630	0	110	110	230	230	350	350	480	480	660	660	880
630	710	0	130	130	260	260	400	400	540	540	740	740	910
710	800	0	140	140	290	290	450	450	610	610	830	830	1100
800	900	0	160	160	330	330	500	500	670	670	920	920	1240

Tapered Roller Bearing

DATA TABLE

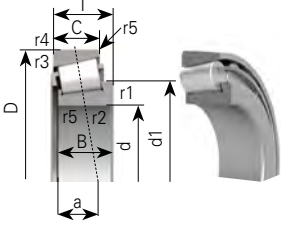

Part number	Principal dimensions			Load ratings			Speed limits		Weight	B	C	Dimen- sions			Calculation factors			
	Bores	Outer	Width	Dynamic	Static	Fatigue	Grease	Oil				r1/r2	r3/r4	r5	a	e	Y	Yo
	d	D	T	Cr	Cor	Pu	rpm		mm	mm	mm	mm	mm	mm	mm	mm		
	mm			kN			1 min ⁻¹		Kg									
30202	15	35	11,75	15,8	14,4	1,76	9000	13000	0,05	11	10	0,6	0,6	0,3	9	0,35	1,7	0,9
30202	15	42	14,25	23,9	21,6	2,63	9000	13000	0,09	13	11	1	1	0,3	9	0,28	2,1	1,1
30203	17	40	13,25	21,2	21,3	2,60	9000	13000	0,08	12	11	1	1	0,3	10	0,35	1,7	0,9
30303	17	47	15,25	32,3	27,6	3,37	8500	12000	0,13	14	12	1	1	0,3	10	0,28	2,1	1,1
32004	20	42	15	26,3	30	3,66	8500	12000	0,01	15	12	0,6	0,6	0,3	10	0,37	1,6	0,9
30204	20	47	15,25	28,2	30,6	3,73	8000	11000	0,12	14	12	1	1	0,3	11	0,35	1,7	0,9
32204	20	47	19,25	37	40,6	4,95	8000	11000	0,16	18	15	1	1	0,3	12,65	0,33	1,81	1,1
30304	20	52	16,25	38,01	33,21	4,05	8000	11000	0,17	15	13	1,5	1,5	0,6	11	0,3	2	1,1
32304	20	52	22,25	44,6	46,3	5,65	7500	10000	0,22	21	18	1,5	1,5	0,6	14	0,3	2	1,1
32005	25	47	15	29,9	33,1	4,04	7900	11000	0,11	15	11,5	0,6	0,6	0,3	11,6	0,43	1,39	0,77
33005	25	47	17	32,5	42,5	5,18	6000	8000	0,13	17	14	0,6	0,6	0,3	13,25	0,3	2	0,9
30205	25	52	16,25	29,4	22,54	2,75	7500	10000	0,15	15	13	1	1	0,3	12	0,37	1,6	0,9
32205	25	52	19,25	43	48	5,85	7500	10000	0,18	18	16	1	1	0,3	16	0,33	1,8	1
33205	25	52	22	51,1	55,8	6,80	6500	9500	0,21	22	18	1	1	0,3	13,87	0,35	1,7	0,9
30305	25	62	18,25	52,5	49,7	6,06	6700	9000	0,25	17	15	1,5	1,5	0,6	13	0,3	2	1,1
31305 A	25	62	18,25	44,8	46,1	5,62	5600	7500	0,25	17	13	1,5	1,5	0,6	20	0,83	0,7	0,4
32305	25	62	25,25	64,6	68,8	8,39	6000	8000	0,36	24	20	1,5	1,5	0,6	15	0,3	2	1,1
32006	30	55	17	38	48,9	5,96	6700	9000	0,17	17	13	1	1	0,3	13	0,43	1,4	0,8
30206	30	62	17,25	50,1	55	6,71	6300	8500	0,22	16	14	1	1	0,3	14	0,37	1,6	0,9
32206	30	62	21,25	54,3	63,7	7,77	6300	8500	0,28	20	17	1	1	0,3	15	0,37	1,6	0,9
30306	30	72	20,75	61,7	63,1	7,70	5600	7500	0,38	19	16	1,5	1,5	0,6	15	0,31	1,9	1,1
31306	30	72	20,75	52,5	60,3	7,35	5000	6700	0,39	19	14	1,5	1,5	0,6	22	0,83	0,7	0,4
32306	30	72	28,75	90,7	96,4	11,76	5300	7000	0,55	27	23	1,5	1,5	0,6	18	0,31	1,9	1,1
32007	35	62	18	42	56	6,83	6000	8000	0,22	18	14	1	1	0,3	15	0,46	1,3	0,7
30207	35	72	18,25	56,8	63,5	7,74	5300	7000	0,32	17	15	1,5	1,5	0,6	15	0,37	1,6	0,9
32207	35	72	24,25	74	89,5	10,91	5300	7000	0,42	23	19	1,5	1,5	0,6	17	0,37	1,6	0,9
33207	35	72	28	91,6	107	13,05	5700	7500	0,52	28	22	1,5	1,5	0,3	18,08	0,35	1,7	0,9
30307	35	80	22,75	85,5	82,6	10,07	5000	6700	0,52	21	18	2	1,5	0,6	16	0,31	1,9	1,1
31307	35	80	22,75	67,9	76,3	9,30	4500	6000	0,52	21	15	2	1,5	0,6	25	0,83	0,7	0,4
32307	35	80	32,75	108,6	118,4	14,44	4800	6300	0,73	31	25	2	1,5	0,6	20	0,31	1,9	1,1
32008	40	68	19	47	67,3	8,21	5300	7000	0,27	19	14,5	1	1	0,3	15	0,37	1,6	0,9
30208	40	80	19,75	63	74	9,02	4800	6300	0,42	18	16	1,5	1,5	0,6	16	0,37	1,6	0,9
32208	40	80	24,75	77,9	97,2	11,85	4800	6300	0,51	23	19	1,5	1,5	0,6	19	0,37	1,6	0,9
30308	40	90	25,25	104,3	107,5	13,11	4500	6000	0,7	23	20	2	1,5	0,6	19	0,35	1,7	0,9
31308	40	90	25,25	81,4	96,4	11,76	4000	5300	0,69	23	17	2	1,5	0,6	28	0,83	0,7	0,4

Tapered Roller Bearing

DATA TABLE



Part number	Principal dimensions			Load ratings			Speed limits		Weight Kg	B	C	Dimensions		Calculation factors				
	Bore	Outer	Width	Dynamic	Static	Fatigue	Grease	Oil				r1/r2	r3/r4	r5	a	e	Y	Yo
	d	D	T	Cr	Cor	Pu	rpm	1 min ⁻¹				mm	mm	mm	mm	mm	mm	mm
32308	40	90	35,25	120,8	147,1	17,94	4000	5300	0,99	33	27	2	1,5	0,6	23	0,35	1,7	0,9
32009	45	75	20	57	82,2	10,02	4800	6300	0,33	20	15,5	1	1	0,3	16	0,4	1,5	0,8
33009	45	75	24	71	103	12,56	4000	5300	0,44	24	19	1	1	0,3	16	0,29	2,04	1,12
33109	45	80	26	87,1	117,2	14,29	4000	5300	0,54	26	20,5	1,5	1,5	0,6	18,99	0,37	1,6	0,9
30209	45	85	20,75	71,3	83,8	10,22	4500	6000	0,47	19	16	1,5	1,5	0,6	18	0,4	1,5	0,8
32209	45	85	24,75	84,1	103	12,56	4500	6000	0,56	23	19	1,5	1,5	0,6	20	0,4	1,5	0,8
33209	45	85	32	109,5	145,1	17,70	4000	5300	0,77	32	25	2	2	0,6	21,71	0,4	1,5	0,8
30309	45	100	27,25	127	131,2	16,00	4000	5300	0,92	25	22	2	1,5	0,6	21	0,35	1,7	0,9
31309	45	100	27,25	95,6	113,8	13,88	3400	4500	0,91	25	18	2	1,5	0,6	31	0,83	0,7	0,4
32309	45	100	38,25	152,2	189,4	23,10	3600	4800	1,25	36	30	2	1,5	0,6	25	0,35	1,7	0,9
32010	50	80	20	60	88	10,73	4500	6000	0,36	20	15,5	1	1	0,3	18	0,43	1,4	0,8
33010	50	80	24	79,7	111,8	13,63	4600	6100	0,46	24	19	1	1	0,3	17,39	0,31	1,9	1,1
33110	50	85	26	89,5	126,2	15,39	4400	5900	0,59	26	20	1,5	1,5	0,6	20	0,4	1,5	0,8
30210	50	90	21,75	73,3	92,1	11,23	4300	5600	0,53	20	17	1,5	1,5	0,6	19	0,43	1,4	0,8
32210	50	90	24,75	86,7	107,6	13,12	4300	5600	0,60	23	19	1,5	1,5	0,6	21	0,43	1,4	0,8
33210	50	90	32	127,8	158,3	19,30	4200	5700	0,86	32	24,5	1,5	1,5	0,6	22,97	0,4	1,5	0,8
30310	50	110	29,25	130,1	157,1	19,16	3600	4800	1,19	27	23	2,5	2	0,6	23	0,35	1,7	0,9
31310	50	110	29,25	108	128,25	15,64	3200	4300	1,16	27	19	2,5	2	0,6	34	0,83	0,7	0,4
32310	50	110	42,25	177,5	236,1	28,79	3200	4300	1,83	40	33	2,5	2	0,6	27	0,35	1,7	0,9
32011 X	55	90	23	79,7	115,6	14,10	4000	5300	0,54	23	17,5	1,5	1,5	0,6	20	0,4	1,5	0,8
33111	55	95	30	127,6	166,3	20,28	4000	5300	0,86	30	23	1,5	1,5	0,6	22	0,37	1,6	0,9
30211	55	100	22,75	94,6	112,8	13,76	3800	5000	0,69	21	18	2	1,5	0,6	20	0,4	1,5	0,8
32211	55	100	26,75	112,7	141,5	17,26	3600	4900	0,83	25	21	2	1,5	0,5	22,83	0,4	1,48	0,81
30311	55	120	31,5	153,3	187,6	22,88	3200	4300	1,53	29	25	2,5	2	0,6	24	0,35	1,7	0,9
31311	55	120	31,5	129,9	158	19,27	2800	3800	1,49	29	21	2,5	2	0,6	37	0,83	0,7	0,4
32311	55	120	45,5	222,9	271,3	33,09	3000	4000	2,21	43	35	2,5	2	0,6	29	0,35	1,7	0,9
32012	60	95	23	83,8	121,5	14,82	3800	5000	0,58	23	17,5	1,5	1,5	0,6	21	0,43	1,4	0,8
33112	60	100	30	128,6	179	21,83	3700	5000	0,93	30	23	1,5	1,5	0,6	23,2	0,4	1,5	0,8
30212	60	110	23,75	103,3	130	15,85	3400	4500	0,86	22	19	2	1,5	0,6	22	0,4	1,5	0,8
32212	60	110	29,75	132,8	179,6	21,90	3400	4500	1,10	28	24	2	1,5	0,6	24	0,4	1,5	0,8
33212	60	110	38	165,8	231,4	28,22	3000	4000	1,50	38	29	2	1,5	0,6	28	0,4	1,48	0,82
30312	60	130	33,5	171,4	210	25,61	3000	4000	1,90	31	26	3	2,5	1	26	0,35	1,7	0,9
31312	60	130	33,5	145,4	176,8	21,56	2600	3600	1,83	31	22	3	2,5	1	39	0,83	0,7	0,4
32312	60	130	48,5	226,7	303	36,95	2600	3600	2,80	46	37	3	2,5	1	31	0,35	1,7	0,9
32013	65	100	23	80,6	123	15,00	3400	4500	0,62	23	17,5	1,5	1,5	0,6	22	0,46	1,3	0,7

Tapered Roller Bearing

DATA TABLE

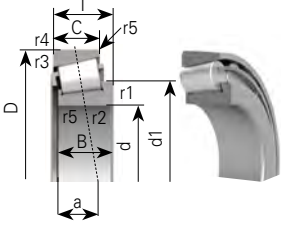

Part number	Principal dimensions			Load ratings			Speed limits		Weight	B	C	Dimen- sions			Calculation factors								
	Bores	Outer	Width	Dynamic	Static	Fatigue	Grease	Oil				r1/r2	r3/r4	r5	a	e	Y	Yo					
	d	D	T	Cr	Cor	Pu	rpm		mm	mm	mm	mm	mm	mm	mm	mm							
	mm			kN			1 min ⁻¹		Kg														
33013	65	100	27	100,5	162,7	19,84	3600	4800	0,75	27	21	1,5	1,5	0,6	21	0,35	1,7	0,9					
33113	65	110	34	153,6	224,6	27,39	3400	4600	1,30	34	26,5	1,5	1,5	0,6	25,6	0,4	1,5	0,8					
30213	65	120	24,75	120,6	152,6	18,61	3000	4000	1,10	23	20	2	1,5	0,6	23	0,4	1,5	0,8					
32213	65	120	32,75	181,9	234,9	28,65	3000	4000	1,48	31	27	2	1,5	0,6	27	0,4	1,5	0,8					
33213	65	120	41	224,3	283,1	34,52	3100	4200	1,99	41	32	2	1,5	0,5	29,5	0,39	1,53	0,84					
30313	65	140	36	230,9	248,6	30,09	2800	3700	2,30	33	28	3	2,5	1	28	0,35	1,7	0,9					
31313	65	140	36	195,7	215,5	26,09	2200	3200	2,25	33	23	3	2,5	1	42	0,83	0,7	0,4					
32313	65	140	51	307,2	358,8	43,43	2400	3400	3,49	48	39	3	2,5	1	33	0,35	1,7	0,9					
32014	70	110	25	95,6	143	17,44	3200	4300	0,83	25	19	1,5	1,5	0,6	23	0,43	1,4	0,8					
33014	70	110	31	127	204	24,88	3200	4200	1,07	31	25,5	1,5	1,5	0,6	22,5	0,28	2,1	1,1					
33114	70	120	37	172	250	30,49	4000	5300	1,70	37	29	2	1,5	0,6	27,6	0,37	1,6	0,9					
30214	70	125	26,25	138,3	173,7	21,18	3000	4000	1,22	24	21	2	1,5	0,6	25	0,43	1,4	0,8					
32214	70	125	33,25	168,5	237,1	28,91	2800	3800	1,56	31	27	2	1,5	0,6	28	0,43	1,4	0,8					
33214	70	125	41	204	290	35,37	2900	3900	2,10	41	32	2	1,5	0,8	30,7	0,41	1,47	0,81					
30314	70	150	38	248,8	271,7	32,20	2400	3400	3	35	30	3	2,5	1	29	0,35	1,7	0,9					
32314	70	150	54	297	381	45,15	2200	3200	4,10	51	42	3	2,5	1	36	0,35	1,7	0,9					
32015	75	115	25	103,1	160,2	19,54	3000	4000	0,88	25	19	1,5	1,5	0,6	25	0,46	1,3	0,7					
33015	75	115	31	129	212	25,85	3000	4000	1,13	31	25,5	1,5	1,5	0,6	23,2	0,3	2	1,1					
33115	75	125	37	176	265	32,32	3800	5000	1,80	37	29	2	1,5	0,6	28,8	0,4	1,5	0,8					
30215	75	130	27,25	138,4	185,4	22,44	2800	3800	1,33	25	22	2	1,5	0,6	27	0,43	1,4	0,8					
32215	75	130	33,25	170,3	242,1	29,31	2600	3600	1,73	31	27	2	1,5	0,6	29	0,43	1,4	0,8					
33215	75	130	41	208	298	36,07	2700	3600	2,20	41	31	2	1,5	0,6	31,6	0,43	1,4	0,8					
30315	75	160	40	252,8	318,8	37,04	2600	3600	3,40	37	31	3	2,5	1	31	0,35	1,7	0,9					
31315	75	160	40	240	245	28,47	3200	4300	3,50	37	26	3	2,5	1	48	0,83	0,7	0,4					
32315	75	160	58	345	480	55,77	2200	3000	5,30	55	45	3	2,5	1	38	0,35	1,7	0,9					
32016	80	125	29	141	220	26,63	2600	3600	1,25	29	22	1,5	1,5	0,6	27	0,43	1,4	0,8					
33016	80	125	36	173	284	34,38	2800	3700	1,60	36	29,5	1,5	1,5	0,6	25,5	0,28	2,1	1,1					
33116	80	130	37	211,6	322,2	38,72	3600	4800	1,90	37	29	2	1,5	0,6	30	0,43	1,4	0,8					
30216	80	140	28,25	167,7	212,9	25,23	2400	3400	1,59	26	22	2,5	2	0,6	28	0,43	1,4	0,8					
32216	80	140	35,25	198,1	279	33,07	2400	3400	2	33	28	2,5	2	0,6	30	0,43	1,4	0,8					
33216	80	140	46	250	365	43,26	2500	3400	2,92	46	35	2,5	2	0,6	34,6	0,43	1,4	0,8					
30316	80	170	42,5	319,7	352,5	40,20	2000	3000	4	39	33	3	2,5	1	33	0,35	1,7	0,9					
31316	80	170	42,5	260	265	30,22	3000	4000	4,05	39	27	3	2,5	1	52	0,83	0,7	0,4					
32316	80	170	61,5	387,9	543,1	61,94	2100	2800	6,10	58	48	3	2,5	1	41	0,35	1,7	0,9					
32017	85	130	29	142	224	26,73	2600	3500	1,35	29	22	1,5	1,5	0,6	28	0,44	1,4	0,8					

Tapered Roller Bearing

DATA TABLE



Part number	Principal dimensions			Load ratings			Speed limits		Weight	B	C	Dimensions		Calculation factors				
	Bore	Outer	Width	Dynamic	Static	Fatigue	Grease	Oil				r1/r2	r3/r4	r5	a	e	Y	Yo
	d	D	T	Cr	Cor	Pu	rpm	rpm	Kg	mm	mm	mm	mm	mm	mm	mm		
33017	85	130	36	176	296	35,32	2600	3500	1,7	36	29,5	1,5	1,5	0,6	26,6	0,3	2	1,1
33117	85	140	41	220	340	40,02	3400	4500	2,4	41	32	2,5	2	0,6	34,4	0,4	1,5	0,8
30217	85	150	30,5	177,6	236,8	27,51	2200	3200	2	28	24	2,5	2	0,6	30	0,43	1,4	0,8
32217	85	150	38,5	227	324	37,65	2200	3200	2,7	36	30	2,5	2	0,6	33	0,43	1,4	0,8
30317	85	180	44,5	305	388	43,49	2100	2900	5	41	34	4	3	1	35	0,35	1,7	0,9
31317	85	180	44,5	242	285	31,94	2600	3800	4,6	41	28	4	3	5	53,9	0,83	0,72	0,4
32317	85	180	63,5	439,4	592	66,35	1900	2700	7,1	60	49	4	3	1	42	0,35	1,7	0,9
32018	90	140	32	198,7	289,4	33,84	2500	3300	1,8	32	24	2	1,5	0,6	30	0,43	1,4	0,8
33018	90	140	39	215	360	42,10	2500	3300	2,2	39	32,5	2	1,5	0,6	27,3	0,27	2,2	0,4
33118	90	150	45	251	390	45,03	3000	4300	3,1	45	35	2,5	2	0,6	35	0,4	1,5	0,8
32218	90	160	42,5	270	396	45,17	2000	3000	3,4	40	34	2,5	2	0,6	36	0,43	1,4	0,8
30318	90	190	46,5	342	441	48,62	2000	2700	5,8	43	36	4	3	1	36	0,35	1,7	0,9
31318	90	190	46,5	308	380	41,89	2400	3400	5,9	43	30	4	3	1	57	0,83	0,7	0,4
32318 A	90	190	67,5	468	625	68,90	2000	2700	8,8	64	53	4	3	1,5	46,2	0,35	1,74	0,96
32019	95	145	32	171	280	32,33	2300	3100	1,8	32	24	2	1,5	0,6	31	0,44	1,4	0,8
33019	95	145	39	219	375	43,30	2300	3100	2,3	39	32,5	2	1,5	0,6	27,6	0,28	2,16	0,4
30219	95	170	34,5	227	309	34,63	2100	2800	3	32	34,2	3	2,5	1,2	27	0,43	1,4	0,8
32219	95	170	45,5	303	448	50,21	1900	2800	4,3	43	37	3	2,5	1	39	0,43	1,4	0,8
30319	95	200	49,5	369	478	51,88	1900	2500	6,8	45	38	4	3	1	39	0,35	1,7	0,9
31319	95	200	49,5	292	355	38,53	2400	3400	9,1	45	32	4	3	1	59,6	0,83	0,72	0,4
32319	95	200	71,5	516	737	79,99	1700	2300	10,1	67	55	4	3	1	47	0,35	1,7	0,9
32020	100	150	32	170	280	31,94	2200	3000	1,9	32	24	2	1,5	0,6	32	0,46	1,3	0,7
33020	100	150	39	224	390	44,48	2200	3000	2,4	39	32,5	0,5	1,5	0,6	28,8	0,28	2,1	1,1
33120	100	165	52	325	607	68,03	2800	4100	4,8	52	40	2,5	2	1	41	0,41	1,48	0,81
30220	100	180	37	254	350	38,58	2000	2700	3,7	34	29	3	2,5	1	35	0,43	1,4	0,8
32220	100	180	49	341	512	56,44	1800	2600	5,1	46	39	3	2,5	1	41	0,43	1,4	0,8
30320	100	215	51,5	406	526	55,97	1800	2400	8,2	47	39	4	3	1	40	0,35	1,7	0,9
31320	100	215	56,5	430	465	49,48	2400	3000	8,7	51	35	4	3	1	45,1	0,83	0,73	0,9
32320	100	215	77,5	600	872	92,79	1600	2100	13	73	60	4	3	1	53	0,35	1,7	0,9
32021	105	160	35	201	335	37,55	2100	2800	2,4	35	26	2,5	2	0,6	34	0,44	1,4	0,8
33021	105	160	43	245	420	47,07	2100	2800	3	43	34	2,5	2	0,6	30,7	0,28	2,1	1,1
33121	105	175	56	360	607	66,92	2600	3800	5,3	56	44	2,5	2	0,6	43	0,4	1,48	0,8
30221	105	190	39	285	399	43,30	1900	2500	4,4	36	30	3	2,5	1	37	0,43	1,4	0,8
32221	105	190	53	381	579	62,84	1700	2500	6,2	50	43	3	2,5	1	44	0,43	1,4	0,8
30321	105	225	53,5	433	562	58,98	1700	2300	9,4	49	41	4	3	3	41,3	0,35	1,7	0,9

Tapered Roller Bearing

DATA TABLE

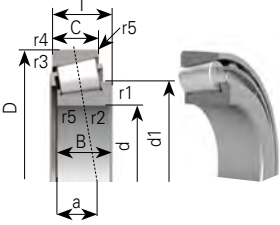

Part number	Principal dimensions			Load ratings			Speed limits		Weight	B	C	Dimen- sions			Calculation factors			
	Bores	Outer	Width	Dynamic	Static	Fatigue	Grease	Oil				r1/r2	r3/r4	r5	a	e	Y	Yo
	d	D	T	Cr	Cor	Pu	rpm		mm	mm	mm	mm	mm	mm	mm	mm		
	mm			kN			1 min ⁻¹		Kg									
32321	105	225	81,5	660	915	96,02	1500	2000	15	77	63	4	4	3	54	0,35	1,7	0,96
32022	110	170	38	234	356,5	39,30	2100	2800	3	38	36,6	2,5	2	1	36,6	0,43	1,4	0,8
33022	110	170	47	288	500	55,12	2000	2700	3,8	56	43	2,5	2	1	33,5	0,28	2,1	1,1
33122	110	180	56	369	630	68,73	2600	3400	5,5	56	43	2,5	2	1	44,1	0,42	1,43	0,8
30222	110	200	41	315	444	47,48	1800	2400	5,2	38	32	3	2,5	1	39	0,43	1,4	0,8
32222	110	200	56	432	666	71,21	1700	2400	7,1	53	46	3	2,5	1	46	0,43	1,4	0,8
30322	110	240	54,5	473	612	63,10	1600	2200	11	50	42	4	3	1	43	0,35	1,7	0,9
31322	110	240	63	457	585	60,32	1900	2800	12	57	38	4	3	1	72,2	0,83	0,73	0,9
32322	110	240	84,5	717	990,7	102,14	1400	1900	17	80	65	4	3	1	55	0,35	1,7	0,9
32024	120	180	38	320	545	58,85	1800	2500	3,3	38	29	2,5	2	0,6	39	0,46	1,3	0,7
33024	120	180	48	292	540	58,31	2600	3400	4,2	48	38	2,5	2	0,6	36,3	0,3	2	1,1
33124	120	200	62	462	785	83,14	2400	3200	7,7	62	48	2,5	2	1	48	0,4	1,51	0,8
30224	120	215	43,5	337	483	50,46	1700	2200	6,2	40	34	3	2,5	1	43	0,43	1,4	0,8
32224	120	215	61,5	549,5	758,6	79,25	1600	2200	9,1	58	50	3	2,5	1	51	0,43	1,4	0,8
30324	120	260	59,5	588,9	745,5	74,99	1500	2000	14	55	46	4	3	1	47	0,35	1,7	0,9
31324	120	260	68	539	695	69,91	1700	2400	15,5	62	42	4	3	1	54,8	0,83	0,73	0,8
32324	120	260	90,5	845	1190	119,70	1300	1800	22,4	86	69	4	3	1	60	0,35	1,7	0,96
32026 X	130	200	45	326	550	57,72	1700	2200	4,9	45	34	2,5	2	1	43,3	0,43	1,38	0,76
30226	130	230	43,75	366	521	53,27	1500	2000	6,9	40	34	4	3	1	45	0,43	1,4	0,8
32226	130	230	67,75	550	830	84,86	1500	2000	11,5	64	54	4	3	1	56	0,43	1,4	0,8
30326	130	280	63,75	710,2	911,1	89,58	1300	1800	17	58	49	5	4	1,5	51	0,35	1,7	0,9
31326	130	280	72	605	780	76,69	1600	2400	18,5	66	44	5	4	1,5	87	0,83	0,7	0,4
32326	130	280	98,75	858	1180	116,02	1100	1600	30,5	93	78	5	4	1,5	66	0,35	1,7	0,9
32028	140	210	45	358,6	580	59,80	1600	2100	5,3	45	34	2,5	2	0,6	46	0,46	1,3	0,7
30228 A	140	250	45,75	434,5	593,6	59,25	1400	1900	8,8	42	36	4	3	1	47	0,44	1,4	0,76
32228	140	250	71,75	644	1000	99,81	1400	1900	14,5	68	58	4	3	1	60	0,43	1,4	0,8
30328 A	140	300	67,75	670	945	90,97	1200	1700	21,2	62	53	5	5	1	54	0,35	1,7	0,96
32328 A	140	300	107,75	1090	1630	156,91	1200	1700	35,8	102	85	5	5	4	74	0,37	1,6	0,9
32030	150	225	48	370	655	66,15	1400	1900	6,4	48	36	3	2,5	1	49	0,46	1,3	0,7
33030	150	225	59	457	865	87,36	2000	2600	8,1	59	46	3	2,5	1	48,2	0,37	1,6	0,9
30230	150	270	49	451	646	63,06	1300	1700	10,8	45	38	4	3	1	50	0,43	1,4	0,8
32230	150	270	77	737	1140	111,28	1200	1700	17,5	73	60	4	3	1	64	0,43	1,4	0,8
30330	150	320	72	825	1060	100,04	1100	1600	28,5	65	55	5	4	1	58	0,35	1,7	0,9
32330	150	320	114	1170	1660	156,67	950	1400	46	108	90	5	4	1	79	0,35	1,74	0,96
32032	160	240	51	435	790	78,25	1400	1800	7,8	51	38	3	2,5	1	52	0,46	1,3	0,7

Tapered Roller Bearing

DATA TABLE



Part number	Principal dimensions			Load ratings			Speed limits		Weight Kg	B	C	Dimen- sions		Calculation factors				
	Bore	Outer	Width	Dynamic	Static	Fatigue	Grease	Oil				r1/r2	r3/r4	r5	a	e	Y	Yo
	d	D	T	Cr	Cor	Pu	rpm	1 min ⁻¹				mm	mm	mm	mm	mm	mm	mm
30232	160	290	52	512	739	70,66	1200	1600	13,3	48	40	4	3	1	54	0,43	1,4	0,8
32232	160	290	84	880	1400	133,86	1100	1600	25,5	80	67	4	3	1	70	0,43	1,4	0,8
30332	160	340	75	913	1180	109,32	1000	1500	29	68	58	5	4	1	61,4	0,35	1,7	0,9
32332 A	160	340	121	1400	2230	206,59	1000	1500	51,7	114	95	5	4	1	81	0,35	1,7	0,96
32034	170	260	57	500	895	86,75	1300	1700	10,5	57	43	3	2,5	1	56	0,44	1,4	0,8
30234	170	310	57	591	866	81,22	1100	1500	16,6	52	43	5	4	1,5	58	0,43	1,4	0,8
32234	170	310	91	1010	1630	152,87	1000	1500	28,5	86	71	5	4	1,5	75	0,43	1,4	0,8
30334	170	360	80	1020	1340	121,99	950	1400	35	72	62	5	4	1,5	65,8	0,35	1,7	0,9
32036	180	280	64	655	1210	114,94	1100	1500	14,5	64	48	3	2,5	1	59	0,43	1,4	0,8
30236	180	320	57	610	912	84,49	1100	1400	17,3	52	43	5	4	1,5	61	0,46	1,3	0,7
32236 A	180	320	91	1063,8	1651,8	153,02	950	1400	32,3	86	71	5	5	4	78	0,45	1,3	0,73
32938	190	260	45	386,4	717,9	68,64	1100	1600	6,5	42	36	2,5	2	2	49	0,38	1,6	0,86
32038	190	290	64	726,8	1210	113,48	1100	1500	15,1	64	48	3	2,5	1	62	0,44	1,4	0,8
30238	190	340	60	715	1000	91,04	1000	1300	20,8	55	46	5	4	1	63,1	0,43	1,4	0,8
32238	190	340	97	1000	1670	152,03	1000	1300	33,3	92	75	5	4	1,5	81	0,43	1,4	0,8
32940	200	280	51	455	935	87,69	1000	1500	9,5	51	39	3	3	2,5	54	0,39	1,5	0,84
32040	200	310	70	817,6	1487,5	136,99	1100	1470	19,3	70	53	3	2,5	1	66	0,43	1,4	0,8
30240	200	360	64	780	1100	98,50	900	1300	25,4	58	48	5	5	4	70	0,44	1,4	0,76
32240	200	360	104	1266,2	1947,7	174,41	900	1300	42,6	98	82	5	5	4	84	0,41	1,5	0,81
32944	220	300	51	471	978	89,54	1000	1400	10	48	41	3	2,5	1	56,1	0,37	1,6	0,88
32044	220	340	76	937,6	1690	151,33	960	1690	25	76	57	4	3	1	72	0,43	1,4	0,8
30244	220	400	72	975	1370	118,99	900	1300	36,8	65	54	5	5	4	77	0,42	1,4	0,79
32244	220	400	114	1671,1	2619,8	227,53	900	1300	62,7	108	50	5	5	4	96	0,44	1,4	0,76
32948	240	320	51	608	1137,3	101,84	850	1200	11,5	51	39	3	3	2,5	64	0,46	1,3	0,7
32048	240	360	76	930	1760	154,37	870	1200	27,5	76	57	4	3	1	78	0,46	1,3	0,7
32248	240	440	127	2043,3	3206,4	270,87	700	950	82,5	120	100	5	5	4	105	0,43	1,4	0,8
32952	260	360	63,5	759,7	1503,1	130,55	800	1100	19,2	60	52	3	3	2,5	60	0,3	2	1,09
32052	260	400	87	1243	2200	187,52	800	1100	40	87	65	5	4	1,5	84	0,43	1,4	0,8
32252	260	480	137	2160	3650	300,62	670	900	105	130	105	6	6	5	113	0,43	1,4	0,77
30352	260	540	114	2015	2730	219,65	670	900	113	102	85	6	6	6	92	0,32	1,9	1,04
32956	280	380	63,5	873,8	1682,5	143,41	800	1100	19,7	60	52	3	3	2,5	64	0,32	1,9	1,03
32056	280	420	87	1194	1840	154,09	750	1000	39,6	87	65	5	5	4	83	0,37	1,6	0,89
32960	300	420	76	1019	2200	182,69	700	950	30,2	72	62	4	4	3	67	0,28	2,1	1,17
32060	300	460	100	1516	2740	223,87	670	900	56,6	100	74	5	5	4	97	0,43	1,4	0,8
30660	300	540	149	2680	4700	372,66	600	800	142	140	115	6	6	5	126	0,43	1,4	0,8

Tapered Roller Bearing

DATA TABLE

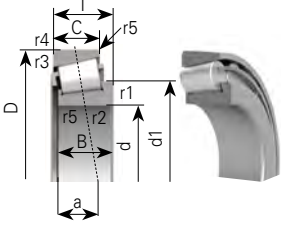

Part number	Principal dimensions			Load ratings			Speed limits		Weight	B	C	Dimen-sions			Calculation factors			
	Bores	Outer	Width	Dynamic	Static	Fatigue	Grease	Oil				r1/r2	r3/r4	r5	a	e	Y	Yo
	d	D	T	Cr	Cor	Pu	rpm											
	mm			kN			1 min ⁻¹		Kg		mm			mm				
32964	320	440	76	1046	2317	189,31	650	900	34,5	76	57	4	4	3	84	0,43	1,4	0,8
32064	320	480	100	1658	3046	245,07	630	850	62,7	100	74	5	5	4	104	0,46	1,3	0,72
30664	320	620	141	2780	4600	352,63	520	680	183	125	107	7,5	7,5	7,5	154	0,6	1	0,6
32968	340	460	76	1000	2350	189,08	500	830	36,5	76	57	4	4	3	90	0,44	1,35	0,8
32972	360	480	76	970	2220	176,02	500	630	38,5	76	57	4	4	4	97	0,46	1,3	0,72
30672	360	680	165	3620	6250	464,80	480	600	262	150	125	7,5	7,5	7,5	172	0,6	1	0,6
30680	400	750	130	2660	4180	301,62	320	430	222	115	77	6	6	6	189	0,7	0,86	0,47
30692	460	860	210	5590	10100	699,27	350	470	512	190	160	7,5	7,5	7,5	218	0,57	1,05	0,6
30696	480	950	240	6980	12500	844,90	310	420	761	225	174	9,5	9,5	9,5	230	0,54	1,1	0,6
306/560	560	1080	265	8910	15700	1018,45	180	270	1063	235	208	9,5	9,5	9,5	241	0,43	1,4	0,8
329/630	630	850	132	3080	7150	478,32	360	450	200	132	95	6	6	6	168	0,46	1,3	0,72
306/630	630	920	134	3410	7100	468,44	320	430	286	128	94	7,5	7,5	7,5	166	0,43	1,4	0,78
306/680	680	1000	190	5580	12500	805,03	250	350	486	188	140	6	6	6	200	0,43	1,4	0,8
319/710	710	950	114	2860	6900	445,98	260	360	210	106	80	6	6	6	175	0,46	1,3	0,72
306/1000	1000	1420	210	8100	18000	1039,02	160	230	966	195	150	7,5	7,5	7,5	278	0,46	1,3	0,72

TECHNICAL NOTEBOOK

ROLLWAY®

THRUST BALL BEARING

SINGLE ACTING



In this section:

Page

Design Characteristics Applications Angular Misalignment ISO Specification .	156
Series Nomenclature Equivalent Load Equations	157
Data Tables	158-160

REGAL®

Thrust Ball Bearing

SINGLE ACTING

DESIGN | CHARACTERISTICS | APPLICATIONS

THRUST BALL BEARINGS

Thrust ball bearings can be applied for high axial loads and low to medium speeds.

However, they cannot take radial loads. They are sensitive to angular deflection and characterized by extremely rigid guidance in axial direction. The thrust loadings in one directions only.

Thrust ball bearings are separable bearings. The single acting thrust ball bearing consists of one shaft washer, one housing washer and one ball set with cage.

The standard cage is made of a steel sheet.

Depending on speed a minimum load is necessary to avoid sliding movements of the ball set, which are caused by centrifugal forces. To compensate for misalignments of the shaft, bearings with spherical housing washers and support washers should be used.

The thrust loading should not drop below a minimum axial load, thus maintaining contact between the balls and the track when centrifugal forces are present.

Single – acting thrust ball bearings



Brass Cage M



Steel Cage

ANGULAR MISALIGNMENT

These are sensitive for axial deflection and cannot accommodated misalignment.

ISO SPECIFICATIONS

- Dimensions in accordance with ISO 104 (latest version)
- Precision class in accordance with ISO 199 (latest version)

SERIES

The standard series are 51100 | 51200 | 51300 | 51400.

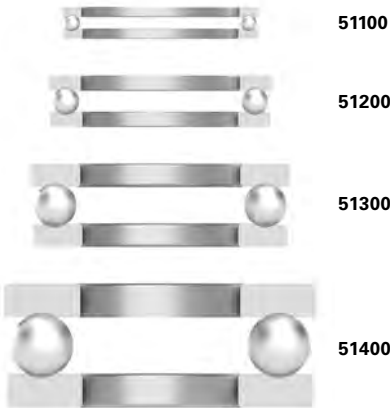

NOMENCLATURE

Suffixes:

M : Brass cage. Typically for bore size over 100 mm

P0 - P6 : Precision class

EQUIVALENT LOAD EQUATIONS

Equivalent dynamic load P_e

$P = F_a$ [KN] where F_a = the axial load

Equivalent static load P_o

$P_o = F_a$ [KN]

Minimum load

For a thrust ball bearing to function correctly it requires axial load in order to ensure that the rolling elements maintain contact with the raceways. This prevents wear due to sliding. F_{am} can be obtained from formula.

Single – acting thrust ball bearings

$$F_{am} = M \left(\frac{n \text{ Max}}{1000} \right)^2 \text{ [N]}$$

where F_{am} = minimum thrust load (N)

M = Factor for minimum load

n = speed in RPM

Thrust Ball Bearing

DATA TABLE - SINGLE ACTING

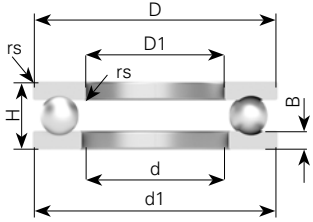

Part number	Principal dimensions			Basic load ratings			Speed limits		Weight	Dimensions			
	Bore	Outer	Height	Dynamic	Static	Fatigue	Grease	Oil		rs min	D1	d1	M
	d	D	H	Cr	Cor	Pu	rpm		mm				
mm			kN			1 min ⁻¹		Kg					
51100	10	24	9	10,0	14,0	0,64	6300	9000	0,02	0,3	11	24	0,001
51101	12	26	9	10,2	15,2	0,69	6000	8500	0,02	0,3	13	26	0,001
51201	12	28	11	13,2	19,0	0,86	5300	7500	0,03	0,6	14	28	0,002
51102	15	28	9	10,5	16,8	0,76	5600	8000	0,02	0,3	16	28	0,001
51202	15	32	12	16,5	24,8	1,13	4800	6700	0,04	0,6	17	32	0,004
51103	17	30	9	10,8	18,2	0,83	5300	7500	0,02	0,5	18	30	0,002
51203	17	35	12	17,0	27,2	1,24	4500	6800	0,05	0,6	19	35	0,004
51104	20	35	10	14,2	24,5	1,11	4800	6700	0,04	0,3	21	35	0,003
51204	20	40	14	22,2	37,5	1,70	3800	5300	0,08	0,6	22	40	0,008
51105	25	42	11	15,2	30,2	1,37	4300	6000	0,06	1,0	26	42	0,005
51205	25	47	15	27,8	50,5	2,30	3400	4300	0,11	0,6	27	47	0,013
51305	25	52	18	35,5	61,5	2,80	3000	4300	0,17	1,0	27	52	0,019
51106	30	47	11	16,0	34,2	1,55	4000	5600	0,06	0,6	32	47	0,007
51206	30	52	16	28,0	54,2	2,46	3200	4500	0,13	0,6	32	52	0,014
51306	30	60	21	42,8	78,5	3,57	2400	3600	0,26	1,0	32	60	0,028
51107	35	52	12	18,2	41,5	1,89	3800	5300	0,08	0,6	37	52	0,009
51207	35	62	18	39,2	78,2	3,55	2800	4000	0,21	1,0	37	62	0,028
51307	35	68	24	55,2	105,0	4,77	2000	3200	0,37	1,0	37	68	0,050
51108	40	60	13	26,8	62,8	2,85	3400	4800	0,11	0,6	42	60	0,016
51208	40	68	19	44,8	91,8	4,17	2400	3600	0,26	1,5	42	68	0,050
51308	40	78	26	69,2	135,0	6,14	1900	3000	0,53	1,0	42	78	0,080
51109	45	65	14	27,0	66,0	3,00	3200	4500	0,14	0,6	47	65	0,020
51209	45	73	20	47,8	105,0	4,77	2200	3400	0,30	1,0	47	73	0,043
51309	45	85	28	75,8	150,0	6,82	1700	2600	0,66	1,0	47	85	0,120
51110	50	70	14	27,2	69,2	3,15	3000	4300	0,15	0,6	52	70	0,024
51210	50	78	22	48,5	112,0	5,09	2000	3200	0,37	1,0	52	78	0,070
51310	50	95	31	96,6	202,0	9,18	1600	2400	0,92	1,1	52	95	0,180
51111	55	78	16	33,8	89,2	4,05	2800	4000	0,22	1,0	57	78	0,038
51211	55	90	25	67,5	158,0	7,18	1900	3000	0,58	1,0	57	90	0,110
51311	55	105	35	115,0	242,0	11,00	1500	2200	1,28	1,1	57	105	0,260
51112	60	85	17	40,2	108,0	4,91	2600	3800	0,27	1,0	62	85	0,053
51212	60	95	26	73,5	178,0	8,09	1800	2800	0,66	1,0	62	95	0,120
51312	60	110	35	118,0	262,0	11,91	1400	2000	1,37	1,1	62	110	0,280
51113	65	90	18	40,5	112,0	5,09	2400	3600	0,31	1,0	67	90	0,060
51213	65	100	27	74,8	188,0	8,55	1700	2600	0,72	1,0	67	100	0,140
51313	65	115	36	115,0	262,0	11,91	1300	1900	1,18	1,1	67	115	0,320

Thrust Ball Bearing

DATA TABLE - SINGLE ACTING



Part number	Principal dimensions			Basic load ratings			Speed limits		Weight	Dimensions			
	Bore	Outer	Height	Dynamic	Static	Fatigue	Grease	Oil		Kg	rs min	D1	d1
	d	D	H	Cr	Cor	Pu	rpm						
	mm			kN			1 min ⁻¹						
51114	70	95	18	40,8	115,0	5,23	2200	3400	0,33	1,5	72	95	0,067
51214	70	105	27	73,5	188,0	8,55	1600	2400	0,75	1,0	72	105	0,160
51314	70	125	40	148,0	340,0	15,45	1200	1800	1,98	1,1	72	125	0,530
51115	75	100	19	48,2	140,0	6,36	2000	3200	0,38	1,0	77	100	0,095
51215	75	110	27	74,8	198,0	9,00	1500	2200	0,82	1,0	77	110	0,180
51315	75	135	44	162,0	380,0	16,86	1100	1700	2,58	1,5	77	135	0,750
51116	80	105	19	48,5	145,0	6,59	1900	3000	0,40	1,0	82	105	0,100
51216	80	115	28	83,8	222,0	10,09	1400	2000	0,90	1,0	82	115	0,220
51316	80	140	44	160,0	380,0	16,47	1000	1600	2,69	1,5	82	140	0,800
51117	85	110	19	49,2	150,0	6,82	1800	2800	0,42	1,0	87	110	0,120
51217	85	125	31	102,0	280,0	12,42	1300	1900	1,21	1,0	88	125	0,180
51317	85	150	49	208,0	495,0	20,76	950	1500	3,47	1,5	88	150	1,100
51118	90	120	22	65,0	200,0	8,87	1700	2600	0,65	1,0	92	120	0,190
51218	90	135	35	115,0	315,0	13,50	1200	1800	1,65	1,1	93	135	0,530
51318	90	155	50	205,0	495,0	20,33	900	1400	3,69	1,5	93	155	1,200
51120	100	135	25	85,0	268,0	11,24	1600	2400	0,95	1,0	102	135	0,360
51220	100	150	38	132,0	375,0	15,25	1100	1700	2,21	1,1	103	150	0,670
51320 M	100	170	55	235,0	595,0	23,28	800	1200	4,86	1,5	103	170	1,800
51122 M	110	145	25	87,0	288	11,59	2500	2200	1,03	1,0	112	145	0,430
51222 M	110	160	38	138,0	412	16,12	2000	1600	2,39	1,1	113	160	0,800
51224 M	120	170	39	135,0	412	15,55	950	1500	2,62	1,1	123	170	0,480
51324 M	120	210	70	347,0	977	34,57	800	1100	10,71	2,1	123	205	1,000
51126 M	130	170	30	111,0	316	11,73	1400	1900	1,86	1,0	170	170	0,750
51226 M	130	190	45	212,0	620	22,28	950	1400	4,44	1,5	133	187	1,700
51128 M	140	180	31	107,0	377	13,55	1300	1800	1,88	1	142	178	0,850
51228 M	140	200	46	215,0	669	23,32	950	1400	4,33	1,5	143	197	1,900
51130 M	150	190	31	109,0	402	14,01	1200	1700	2,188	1	152	188	0,900
51230 M	150	215	50	257,0	795	26,75	900	1300	6,05	1,5	153	212	2,800
51330 M	150	250	80	377,0	1200	38,57	670	900	16,4	3	154	245	9,000
51430 M	150	300	120	668,0	2242	67,94	-	650	42,00	4,0	154	295	20,000
51132 M	160	200	31	112,0	427	14,47	1200	1700	2,2	1	162	198	1,000
51232 M	160	225	51	247,0	803	26,31	850	1200	6,5	1,5	163	222	3,200
51134 M	170	215	34	134,0	512	16,77	1100	1600	2,96	1,1	172	213	1,400
51234 M	170	240	55	269,0	874	27,75	800	1100	6,56	1,5	173	237	4,500
51334 M	170	280	87	463,0	1570	47,58	600	800	22,1	3	174	275	13,000

Thrust Ball Bearing

DATA TABLE - SINGLE ACTING

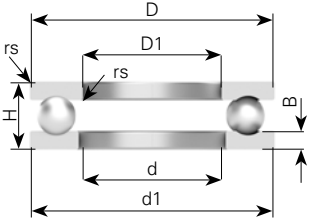

Part number	Principal dimensions			Basic load ratings			Speed limits		Weight	Dimensions			
	Bore	Outer	Height	Dynamic	Static	Fatigue	Grease	Oil		rs min	D1	d1	M
	d	D	H	Cr	Cor	Pu	rpm		mm				
mm			kN			1 min ⁻¹		Kg					
51136 M	180	225	34	135,0	528	16,87	1000	1500	3,082	1,1	183	222	1,500
51236 M	180	250	56	294,0	986	30,57	800	1100	8,7	1,5	183	247	5,000
51336 M	180	300	95	463,0	1580	46,36	560	750	28,10	3,0	184	295	18,000
51138 M	190	240	37	170,0	657	20,37	950	1400	3,94	1,1	193	237	2,400
51238 M	190	270	62	357,0	1019	30,54	750	1000	12	2	194	267	8,400
51338 M	190	320	105	607,0	1662	47,31	700	800	36,76	4,0	195	315	30,000
51140 M	200	250	37	169,0	602	18,24	950	1400	4,07	1,1	203	247	2,400
51240 M	200	280	62	333,0	1207	35,41	750	1000	12,2	2	204	275	8,000
51144 M	220	270	37	177,0	739	21,46	900	1300	4,6	1,1	223	267	3,000
51244 M	220	300	63	342,0	1308	36,87	700	950	13,2	2	224	295	9,500
51148 M	240	300	45	230,0	91	2,52	850	1200	7,3	1,5	243	297	5,000
51248 M	240	340	78	463,0	1889	50,42	600	800	23	2,1	244	335	18,000
51152 M	260	320	45	236,0	984	26,26	750	1000	8,1	1,5	263	317	5,600
51252 M	260	360	79	473,0	1967	50,78	560	750	23,3	2,1	264	355	22,000
51156 M	280	350	53	337,0	1435	36,75	700	950	12	1,5	283	347	10,000
51256 M	280	380	80	506,0	2168	54,25	560	750	26,5	2,1	284	375	24,000
51160 M	300	380	62	400,0	1530	37,72	630	850	17,4	2	304	376	14,000
51260 M	300	420	95	625,0	2872	68,80	480	630	41,7	3	304	415	40,000
51164 M	320	400	63	390,0	1580	37,85	600	800	18,5	2	324	396	16,000

TECHNICAL NOTEBOOK

THRUST BALL BEARING

DOUBLE ACTING



In this section:

	Page
Design Characteristics Applications Angular Misalignment ISO Specification .	162
Series Nomenclature Equivalent Load Equations	163
Data Tables	164-166

REGAL[®]

Thrust Ball Bearing

DOUBLE ACTING

DESIGN | CHARACTERISTICS | APPLICATIONS

DOUBLE ACTING THRUST BALL BEARING

Differs from the Single - acting thrust ball bearings in a way that it can carry the thrust load in 2 directions and with a low to medium speeds. The thrust load is always carried between the central shaft washer and one of the housing washers. They are sensitive to angular deflection and characterized by extremely rigid guidance in axial direction.

Thrust ball bearings are separable bearings. The double acting bearing is made of 5 separable parts and consists of one shaft washer, two housing washers and 2 ball sets with cage.

The standard cage is made of a steel sheet

Double – acting thrust ball bearing

The double-acting type consists of a shaft washer (center washer) and two housing washer and two ball sets with cages. This bearing can carry thrust loadings in both directions.



Brass Cage M



Steel Cage

ANGULAR MISALIGNMENT

These are sensitive for axial deflection and cannot accommodate misalignment.

ISO SPECIFICATIONS

- Dimensions in accordance with ISO 104 (latest version)
- Precision class in accordance with ISO 199 (latest version)

SERIES

The standard series are 52200 | 52300.

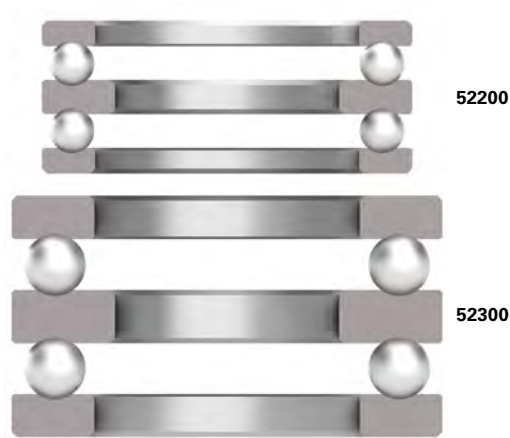

NOMENCLATURE

Suffixes:

M : Brass cage. Typically for bore size over 100 mm

P0 - P6 : Precision class

EQUIVALENT LOAD EQUATIONS

Equivalent dynamic load P_e

$P = F_a$ [KN] where F_a = the axial load

Equivalent static load P_o

$P_o = F_a$ [KN]

Ball thrust bearings must have a minimum thrust load to function correctly. This ensures that sliding does not occur due to centrifugal forces acting on the ball and cage assembly.

Minimum load

For a thrust ball bearing to function correctly it requires axial load in order to ensure that the rolling elements maintain contact with the raceways. This prevents wear due to sliding. F_{am} can be obtained from formula.

$$F_{am} = M \left(\frac{n \text{ Max}}{1000} \right)^2 \text{ [N]}$$

where F_{am} = minimum thrust load (N)

M = Factor for minimum load

n = speed in RPM

Thrust Ball Bearing

DATA TABLE - DOUBLE ACTING

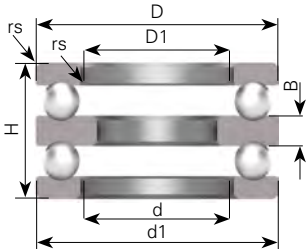

Part number	Principal dimensions			Basic load ratings			Speed limits		Weight	Dimensions			
	Bore	Outer	Height	Dynamic	Static	Fatigue	Grease	Oil		rs min	D1	d1	M
	d	D	H	Cr	Cor	Pu	rpm		Kg				
mm			kN			1 min ⁻¹		mm					
52202	10	32	22	17	25	1,14	5000	6700	0,09	0,6	0,3	17	5
52204	15	40	26	22	38	1,73	4300	5600	0,15	0,6	0,3	22	6
52405	15	60	45	56	89	4,05	2600	3600	0,63	1,0	0,3	27	11
52205	20	47	28	28	50	2,27	3800	5000	0,23	0,6	0,3	27	7
52305	20	52	34	36	61	2,77	3200	4300	0,33	1,0	0,3	27	8
52406	20	70	52	73	126	5,73	2000	3000	1,00	1,0	0,6	32	12
52206	25	52	29	28	54	2,45	3600	4800	0,27	0,6	0,3	32	7
52306	25	60	38	43	79	3,59	2800	3800	0,49	1,0	0,3	32	9
52407	25	80	59	87	155	7,05	1800	2600	1,44	1,1	0,6	37	14
52207	30	62	34	41	84	3,82	3000	4000	0,42	1,0	0,3	37	8
52208	30	68	36	47	98	4,45	2800	3800	0,54	1,0	0,6	42	9
52307	30	68	44	56	105	4,77	2400	3400	0,71	1,0	0,3	37	10
52308	30	78	49	69	135	6,14	2000	3000	1,06	1,0	0,6	42	12
52408	30	90	65	113	205	9,32	1700	2400	2,08	1,1	0,6	42	15
52209	35	73	37	48	105	4,77	2600	3600	0,62	1,0	0,6	47	9
52309	35	85	52	81	163	7,41	1900	2800	1,29	1,0	0,6	47	12
52409	35	100	72	130	242	11,00	1600	2200	2,71	1,1	0,6	47	17
52210	40	78	39	49	111	5,05	2400	3400	0,71	1,0	0,6	52	9
52310	40	95	58	92	186	8,45	1800	2600	1,86	1,1	0,6	52	14
52410	40	110	78	148	283	12,86	1500	2000	3,56	1,5	0,6	52	18
52211	45	90	45	69	159	7,23	1900	2800	1,12	1,0	0,6	57	10
52311	45	105	64	119	246	11,18	1600	2200	2,51	1,1	0,6	57	15
52411	45	120	87	178	359	16,32	1300	1800	4,70	1,5	0,6	57	20
52212	50	95	46	74	179	8,14	1900	2800	1,25	1,0	0,6	62	10
52312	50	110	64	124	267	12,14	1600	2200	2,68	1,1	0,6	62	15
52412	50	130	93	201	397	18,05	1100	1600	6,33	1,5	0,6	62	21
52413	50	140	101	232	493	22,41	1000	1500	8,03	2,0	1,0	68	23
52213	55	100	47	75	189	8,59	1800	2600	1,36	1,0	0,6	67	10
52214	55	105	47	74	189	8,59	1800	2600	1,48	1,0	1,0	72	10
52313	55	115	65	128	287	13,05	1500	2000	2,90	1,1	0,6	67	15
52314	55	125	72	148	339	15,41	1400	1900	3,90	1,1	1,0	72	16
52215	60	110	47	77	209	9,50	1700	2400	1,57	1,0	1,0	77	10
52315	60	135	79	171	396	18,00	1200	1700	4,83	1,5	1,0	77	18
52216	65	115	48	79	218	9,91	1700	2400	1,69	1,0	1,0	82	10
52316	65	140	79	176	424	19,04	1200	1700	5,06	1,5	1,0	82	18

Thrust Ball Bearing

DATA TABLE - DOUBLE ACTING



Part number	Principal dimensions			Basic load ratings			Speed limits		Weight	Dimensions			
	Bore	Outer	Height	Dynamic	Static	Fatigue	Grease	Oil		rs min	D1	d1	M
	d	D	H	Cr	Cor	Pu	rpm		Kg				
	mm			kN			1 min ⁻¹						
52217	70	125	55	92	251	11,41	1600	2200	2,34	1,0	1,0	88	12
52317	70	150	87	206	489	21,19	1100	1600	6,43	1,5	1,0	88	19
52218	75	135	62	117	326	14,46	1500	2000	3,22	1,1	1,0	93	14
52318	75	155	88	213	524	22,21	1000	1500	6,60	1,5	1,0	93	19
52420	80	210	150	368	983	37,11	700	950	26,60	2,0	1,0	103	33
52220	85	150	67	147	410	17,19	1300	1800	4,29	1,1	1,0	103	15
52320	85	170	97	236	596	23,99	950	1400	8,90	1,5	1,0	103	21
52322	95	90	110	280	754	34,27	850	1200	13,80	2,0	1,0	113	24
52222	95	160	67	148	431	17,35	1200	1700	4,68	1,1	1,0	113	15
52224	100	170	68	154	472	18,47	1100	1600	5,24	1,1	1,1	123	15
52324	100	210	123	325	931	33,99	800	1100	17,20	2,1	1,1	123	27
52226	110	190	80	203	622	23,08	950	1400	7,74	1,5	1,1	133	18
52228 M	120	200	81	215	669	24,04	950	1400	8,95	1,5	1,1	143	18
52230 M	130	215	89	244	768	26,58	900	1300	10,60	1,5	1,1	153	20
52330 M	130	250	140	377	1200	39,57	670	900	27,10	2,1	1,1	154	31
52232 M	140	225	90	247	803	27,02	850	1200	12,20	1,5	1,1	163	20
52332 M	140	250	140	470	1570	51,10	630	850	26,20	2,1	1,1	154	31
52234 M	150	240	97	269	874	28,45	800	1100	15,20	1,5	1,1	173	21

TECHNICAL NOTEBOOK

ROLLWAY®

SPHERICAL ROLLER THRUST BEARING



In this section:

	Page
Design Characteristics Applications Angular Misalignment	
ISO Specification	168
Seriele Nomenclature Equivalent Load Equations Lubrication	169
Data Tables	170-172

REGAL®

Spherical Roller Thrust Bearing

DESIGN | CHARACTERISTICS | APPLICATIONS

These bearings can accommodate heavy thrust loads and, due to raceways being inclined to the bearings axis, they can also accommodate radial loads up to a maximum of 55% of the thrust load and are suitable for taking high thrust loads at relatively high speed. Misalignment depends on the series (figures show below).

The bearings are fitted with asymmetrical barrel-shaped rollers.

It is essential that a minimum thrust load be present to avoid damage to the raceways by centrifugal forces (see formula below).

For static loads, a safety factor S_o of 4 should be used.

The steel cage version is available in the 294 series and is suitable for twin extruder gearboxes.

$$\frac{1.5 \text{ Cor}}{1000} F_{a \text{ min}} = [\text{KN}]$$

Where $F_{a \text{ min}}$ = minimum thrust load [KN]

Cor = static capacity [KN]

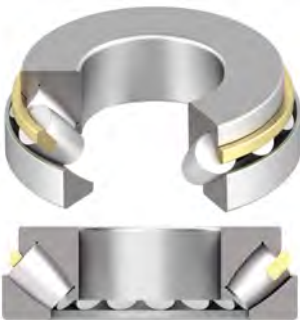

EM: Brass Cage



EX1: Steel Cage

ANGULAR MISALIGNMENT

Misalignment depends on the series (figures show below).

Series	Misalignent
292	2°
293	2.5°
294	3°

ISO SPECIFICATIONS

- Dimensions in accordance with ISO 104 (latest version)
- Precision class in accordance with ISO 199 (latest version)

SERIES

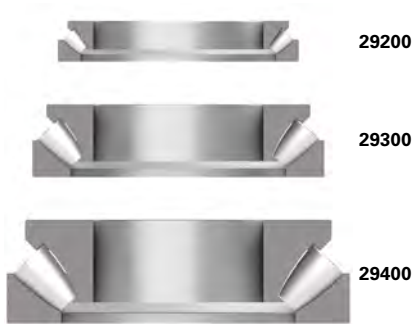

NOMENCLATURE

Suffixes:

EM : Increased load rating | Brass cage

EX1 : Steel cage for series 294

P0 - P6 : Precision class

EQUIVALENT LOAD EQUATIONS

Equivalent dynamic load

$$P = Fa + 1.2 Fr \quad \text{providing} \quad Fr \leq 0.55 Fa$$

Equivalent static load

$$Po = Fa + 2.7 Fr \quad \text{providing} \quad Fr \leq 0.55 Fa$$

Equivalent static load

This can be calculated from

$$F_{am} = \frac{1.25 \cdot Co}{1000} \quad [\text{kN}]$$

where: F_{am} = minimum axial load [kN]

Fr = radial component of load for bearings subjected to combined load [kN]

Co = basic static load [kN]

In many cases the axial load acting on the bearing produced by the weight of the supporting component parts and external forces is greater than the required minimum load. If this is not the case, then bearings must be preloaded. (e.g. using springs)

LUBRICATION

We recommend to lubricate the spherical thrust roller bearing with oil. When the bearing is rotating an oil pump effect is created which lets the oil circulate inside the bearing and will cool it down.

Spherical Roller Thrust Bearing

DATA TABLE

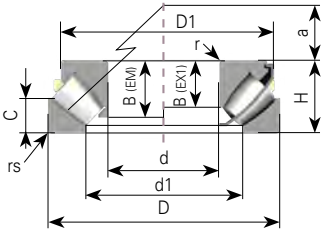

Part number	Principal dimensions			Basic load ratings			Speed limits		Weight	Radius	Calculation factors				
	Bore	Outer	Width	Dynamic	Static	Fatigue	Grease	Oil			d1	D1	B	C	a
	d	D	H	Cr	Cor	Pu	rpm	1 min ⁻¹	Kg	rs min mm	mm				
29412 EX1	60	130	42	390,0	1090	132,9	1800	2600	2,52	1,5	85,5	112	27	21	38
29413 EX1	65	140	45	418,2	1126	136,3	1550	2200	3,41	2	91,5	125	36	21,9	42
29414 EX1	70	150	48	520,0	1250	148,1	1600	2200	4,13	2	99	129	31	23,8	44,8
29415 EX1	75	160	51	600,0	1430	166,2	1600	2200	4,56	2	105,5	137	33,5	24,5	47
29416 EX1	80	170	54	670,0	1630	185,9	1400	2000	5,50	2,1	112,5	146	35	26,5	50
29317 EM	85	150	39	300	1050	122	1500	2000	2,87	1,5	110,0	135	31	19,4	50
29417 EM	85	180	58	653	1815	203	1200	1600	7,19	2,1	119,5	160	46	27,5	54
29318 EM	90	155	39	370	1139	131	1500	2000	3,06	1,5	115,5	140	31	19,8	52
29418 EX1	90	190	60	815,0	2000	220	1300	1900	7,56	2,1	128	164	39	28,5	56
29320 EM	100	170	42	440	1400	156	1400	1800	3,91	1,5	127,5	155	32,5	21,2	58
29420 EX1	100	210	67	970,0	2910	311	1200	1700	10,80	3	141,5	186	43	32,2	62
29322 EM	110	190	48	542	1740	188	1200	1600	5,67	2	141,5	175	37	23,9	64
29422 EX1	110	230	73	1180	3000	312	1100	1600	13,40	3	223,5	199	47	34,7	69
29324 EM	120	210	54	685	2230	234	1000	1400	7,96	2,1	155,0	190	41	27,2	70
29424 EX1	120	250	78	1370	3450	350	900	1300	16,65	4	171	216	50,5	36,5	74
29326 EM	130	225	58	770	2520	259	900	1400	9,45	2,1	167,0	205	44,5	28,3	76
29426 EX1	130	270	85	1382	4160	412	780	1100	22,06	4	181,0	240	66,5	41,1	81
29328 EM	140	240	60	868	2940	296	850	1200	11,20	2,1	178,0	220	46,5	29,6	82
29428 EX1	140	280	85	1433	4436	433	780	1000	24,60	4	192,5	250	66,5	41,4	86
29330 EM	150	250	60	884	3065	304	850	1200	11,70	2,1	188,0	230	46	30	87
29430 EX1	150	300	90	1740	5220	499	800	1100	27,70	4	207,5	262	58	43,4	92
29332 EM	160	270	67	1021	3486	338	800	1100	15,50	3	204,0	245	51	33	92
29432 EX1	160	320	95	2080	5600	525	700	1000	32,70	5	223,5	279	60,5	45,5	99
29234 EM	170	240	42	439	1760	173	1600	5,54	1,5	199,0	225	32	20	92	
29334 EX1	170	280	67	1044	3644	348	800	1000	16,30	3	214,5	255	51	32,9	96
29434 EX1	170	340	103	2360	6550	603	700	950	40	5	236	297	65,5	50	104
29236 EM	180	250	42	420	2010	195	750	1300	7,05	1,5	208,0	236	32	22	96
29336 EX1	180	300	73	1244	4387	411	1000	20,70	3	227,5	275	55,2	35,8	103	
29436 EX1	180	360	109	2275	7317	662	1760	5500	52,20	5	247,5	320	84,5	52,5	110
29238 EM	190	270	48	518	2460	234	1300	7,95	2	220,0	255	36	25,4	102	
29338 EX1	190	320	78	1398	4955	456	580	760	25,50	4	240,0	295	59,5	39,2	110
29438 EX1	190	380	115	2850	8000	713	630	850	56,60	5	264,5	332	73	55,5	117
29240 EM	200	280	48	546	2518	236	1300	9,08	2	230,0	263	39	24	108	
29340 EX1	200	340	85	1582	5566	504	650	800	32	4	253,5	310	64	42,7	116
29440 EX1	200	400	122	2785	9070	796	550	760	73	5	275,0	360	93,5	59	122

Spherical Roller Thrust Bearing

DATA TABLE



Part number	Principal dimensions			Basic load ratings			Speed limits		Weight	Radius	Calculation factors				
	Bore	Outer	Width	Dynamic	Static	Fatigue	Grease	Oil			rs min	d1	D1	B	C
	d	D	H	Cr	Cor	Pu	rpm	1 min ⁻¹	Kg	mm	mm				
29244 EM	220	300	48	694	2974	272		1200	9,84	2	249,5	285	36	25,4	117
29344 EM	220	360	85	1608	5822	516	650	800	34,50	4	275,0	330	64	42,6	125
29444 EM	220	420	122	2870	9634	829	500	680	74,20	6	275,0	360	93,5	59	122
29248 EM	240	340	60	977	4077	361		1000	17,10	2,1	278,0	320	44	31,7	130
29348 EM	240	380	85	1700	6412	557	630	800	36,30	4	297,0	350	64	42,1	135
29448 EM	240	440	122	2978	10298	870	500	630	83	6	316,0	400	93,5	60,1	142
29252 EM	260	360	60	1050	4598	399		1000	18,50	2,1	300,5	340	45,5	30,4	139
29352 EM	260	420	95	2110	8050	680	550	710	51,50	5	323,0	385	71,8	48,2	148
29452 EX1	260	480	132	4050	12900	1062	500	670	97,80	6	346	427,9	86	63	154
29256 EM	280	380	60	1050	4598	392		900	19,50	2,1	321,0	360	45	31	150
29356 EM	280	440	95	2220	8767	728	550	710	54	5	343,0	405	71,8	48	158
29456 EM	280	520	145	4131	14645	1178	430	560	137	6	370,5	470	110	72,4	166
29260 EM	300	420	73	1466	6488	539		710	31	3	348,0	395	54,5	36,4	162
29360 EM	300	480	109	2682	10400	843	500	700	69,60	5	370,5	440	81	55,9	168
29460 EM	300	540	145	4250	15449	1225	400	500	146	6	392,0	490	110	72,4	175
29264 EM	320	440	73	1521	6893	563		630	32,80	3	368,5	415	54	37,4	172
29364 EM	320	500	109	2833	11360	907	450	560	80	5	391,5	465	81	55,2	180
29464 EM	320	580	155	4917	18167	1411	380	500	179	7,5	417,5	525	118,5	76,7	191
29268 EM	340	460	73	1570	7304	588		630	34,50	3	389,0	435	54,5	36,5	183
29368 EM	340	540	122	3373	13425	1050	400	500	106	5	419,5	500	90,5	60,6	192
29468 EM	340	620	170	5504	20070	1529	340	450	228	7,5	446,0	560	128	84,5	201
29272 EM	360	500	85	1989	9084	715		560	50,40	4	417,0	475	63	42,7	194
29372 EM	360	560	122	3442	13990	1079		500	140	5	440,0	520	91	60,8	202
29472 EM	360	640	170	5682	21212	1596		450	234	7,5	467,5	580	129	83,1	210
29276 EM	380	520	85	2002	9307	723		560	52,80	4	437,5	490	65	43,1	202
29376 EM	380	600	132	3962	16164	1224		500	140	6	466,0	555	98,5	66,9	216
29476 EM	380	670	175	6025	22737	1686		430	263	7,5	490,5	610	130	85,9	230
29280 EM	400	540	85	2065	9839	754		700	55,10	4	457,5	510	63,3	42,6	212
29380 EM	400	620	132	4040	16810	1257		450	146	6	487,5	575	98	66,9	225
29480 EM	400	710	185	6757	25820	1883		380	314	7,5	517,5	645	140	94	236
29284 EM	420	580	95	2536	12067	908		560	74,90	5	483,5	550	72	49,7	225
29384 EM	420	650	140	4434	18466	1362		420	170	6	512,5	600	103,5	70,7	235
29484 EM	420	730	185	6969	27200	1963		370	325	7,5	538,0	665	142	92,1	244
29288 EM	440	600	95	2618	12747	948		560	79	5	503,5	570	72	49,6	235
29388 EM	440	680	145	4757	20018	1456		400	192	6	536,5	630	108	73,7	245

Spherical Roller Thrust Bearing

DATA TABLE

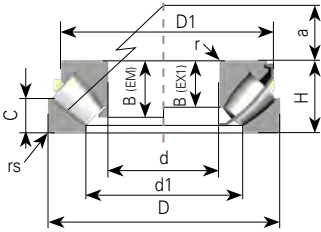

Part number	Principal dimensions			Basic load ratings			Speed limits		Weight	Radius	Calculation factors				
	Bore	Outer	Width	Dynamic	Static	Fatigue	Grease	Oil			rs min	d1	D1	B	C
	d	D	H	Cr	Cor	Pu	rpm	1 min ⁻¹	Kg	mm	mm	mm	mm	mm	mm
29488 EM	440	780	206	8073	31032	2200		350	421	9,5	570,0	710	152	105	260
29292 EM	460	620	95	2644	13085	962		500	80,90	5	524,5	590	72	49,4	245
29392 EM	460	710	150	5205	22264	1598		400	216	6	558,5	660	112	76,6	257
29492 EM	460	800	206	8325	32668	2294		350	435	9,5	592,5	730	149	107	272
29296 EM	480	650	103	2982	14620	1061		480	98	5	549,0	620	76,5	52,1	259
29396 EM	480	730	150	5214	22550	1603		400	224	6	579,5	675	112	76	270
29496 EM	480	850	224	9419	36691	2535		320	534,20	9,5	623,0	770	166,5	111,8	280
292500 EM	500	670	103	3012	14987	1076		450	101	5	569,5	640	76,5	52	268
293500 EM	500	750	150	5322	23422	1648		360	231	6	600,0	700	112	76,2	280
294500 EM	500	870	224	9520	40000	2739		320	559	9,5	643,0	790	170	109,1	290
292530 EM	530	710	109	3356	16859	1189		400	108	5	603,0	675	81	55,2	288
293530 EM	530	800	160	6057	26973	1863		320	270	7,5	639,5	745	119,5	81	295
294530 EM	530	920	236	10703	42908	2888		300	650	9,5	682,0	840	177	118,5	309
292560 EM	560	750	115	3100	8600	597		350	140	5	640,0	715	84	56,8	302
293560 EM	560	850	175	5790	29700	2016		280	320	7,5					
294560 EM	560	980	250	10210	47800	3160		250	740	12	890,0	727	92	120	328
292600 EM	600	800	122	3420	20100	1367		300	172	5	688,0	760	39	60	321
293600 EM	600	900	180	6350	32600	2172		250	368	7,5	731,0	870	61	87	335
294600 EM	600	1030	258	12730	52273	3397		200	880	12	766,0	940	200	128,7	347
292630 EM	630	850	132	4770	24500	1639		250	218	6	728,0	814,5	94	67,3	338
293630 EM	630	950	190	7070	37000	2427		200	438	9,5	880,0	761	68	92	359
294630 EM	630	1090	280	13700	58200	3722		200	1000	12	995,0	815	107	137	365
292670 EM	670	900	140	4900	26000	1709		380	225	6	773,0	855	93	74	364
293670 EM	670	1000	200	7720	40300	2600		150	501	9,5					
292710 EM	710	950	145	4840	29400	1900			261	6					
293710 EM	710	1060	212	8570	45100	2859		260	620	9,5	995,0	857,5	150	103,5	724
294710 EM	710	1220	308	16800	71000	4386		220	1500	15	1130	910	113	148,5	415
292750 EM	750	1000	150	5180	31900	2029		200	311	6	854,5	955	108	76	406
293750 EM	750	1120	224	9370	50600	3156		250	696	9,5					
294750 EM	750	1280	315	15000	76000	4624		300	1536	18	972,0	1164	222	158	436
292800 EM	800	1060	155	5620	35300	2205		340	339	7,5	1010,0	907,5	50	80	426
293800 EM	800	1180	230	10110	54900	3366			780	9,5	1099	958	78	117	440
292850 EM	850	1120	160	6080	38900	2388			389	7,5					
294850 EM	850	1440	354	28600	100000	5869		150	2090	7,5	1098,0	1330	221	172	494
292900 EM	900	1180	170	6590	42000	2537		250	444	7,5	1017,0	1129,5	122	86	477
292950 EM	950	1250	180	8430	46900	2786		240	537	7,5	1081,0	1185	58	88	507

TECHNICAL NOTEBOOK

ROLLWAY®

ACCESSORIES

SLEEVES | NUTS | LOCKING DEVICES



In this section:

Page

Design Characteristics Applications ISO Specification.....	174
Nomenclature Tolerance.....	175-177
Data Tables:	
Adapter Sleeve	177-183
Withdrawal Sleeve.....	184-190
Locking Nut.....	191-192
Locking Device	193-194

REGAL®

Accessories

DESIGN | CHARACTERISTICS | APPLICATIONS

Adapter sleeves are used to locate tapered bore bearings on cylindrical shafts. This allows less accurate machining of the shafts and ease of location.

Adapter sleeves are available in metric or inch bore sizes - the external taper is 1 : 12.

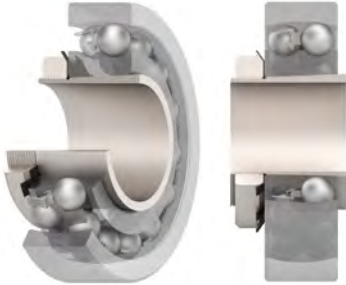

Adapter sleeve

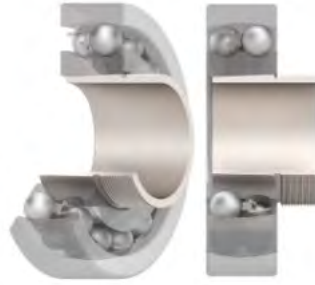

Withdrawal sleeve



Locking device



Locking nut

ISO SPECIFICATIONS

- Sleeve dimensions in accordance with ISO 2982-1
- Nuts and washers dimensions in accordance with ISO 2982-2

NOMENCLATURE

Prefixes:

- H : Adapter sleeve for Metric shaft
- HA - HE : Adapter sleeve for inch size shaft
- AH : Withdrawal sleeve
- AHX : Withdrawal sleeve with modified thread diameter
- KM : Nut, included in H ($d \leq 220$ mm)
- MB : Locking device
- HM : Nut designed for locking clip
- MS : Locking clip ($d > 220$ mm)
- HMV...E : Hydraulic dismounting nut

Suffixes:

- OH : Hydraulic sleeve
- G : Modified thread
- 2P : Split sleeve

TOLERANCES

PERMISSIBLE GEOMETRICAL INACCURACY FOR SLEEVES

	Permissible geometrical inaccuracy (out-of-roundness taper)	Maximum inclination in degrees
Adapter sleeves and withdrawal sleeves	IT 5/2	h7
	IT 5/2	h8
	IT 6/2	h9

SHAFT TOLERANCES FOR ADAPTER SLEEVES AND WITHDRAWAL SLEEVES

d		h7		IT 5/2	h8		IT 5/2	h9		IT 6/2
mm		min.	max.	max.	min.	max.	max.	min.	max.	max.
0	0	0	0	0	0	0	0	0	0	0
6	10	0	-15	3	0	-22	3	0	-36	4.5
10	18	0	-18	4	0	-27	4	0	-43	5.5
18	30	0	-21	4.5	0	-39	4.5	0	-52	6.5
30	50	0	-25	5.5	0	-39	5.5	0	-62	8
50	80	0	-30	6.5	0	-46	6.5	0	-74	9.5
80	120	0	-35	7.5	0	-54	7.5	0	-87	11
120	180	0	-40	9	0	-63	9	0	-100	12.5
180	250	0	-46	10	0	-72	10	0	-115	14.5
250	315	0	-52	11.5	0	-81	11.5	0	-130	16
315	400	0	-57	12.5	0	-89	12.5	0	-140	18
400	500	0	-63	13.5	0	-97	13.5	0	-155	20

Note: IT basic tolerances indicate accepted from circularity and cylindricity.

TOLERANCES FORTAPERED BORES – TAPER 1:12 NOMINAL DIMENSIONS

d		h7		IT 5/2	h8		IT 5/2	h9		IT 6/2
mm		min.	max.	max.	min.	max.	max.	min.	max.	max.
0	0	0	0	0	0	0	0	0	0	0
6	10	0	-15	3	0	-22	3	0	-36	4.5
10	18	0	-18	4	0	-27	4	0	-43	5.5
18	30	0	-21	4.5	0	-39	4.5	0	-52	6.5
30	50	0	-25	5.5	0	-39	5.5	0	-62	8
50	80	0	-30	6.5	0	-46	6.5	0	-74	9.5
80	120	0	-35	7.5	0	-54	7.5	0	-87	11
120	180	0	-40	9	0	-63	9	0	-100	12.5
180	250	0	-46	10	0	-72	10	0	-115	14.5
250	315	0	-52	11.5	0	-81	11.5	0	-130	16
315	400	0	-57	12.5	0	-89	12.5	0	-140	18
400	500	0	-63	13.5	0	-97	13.5	0	-155	20

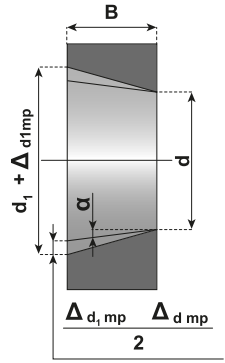

$\alpha = 2^{\circ}23'9,4'' = 2.38594^{\circ}$
 $= 0.041643$ rad half the angle of taper

PRECISION CLASS P0

Tolerances in μm

d mm		$\Delta d_{mp}^{(1)}$		$\Delta d_{1mp} - \Delta d_{mp}^{(2)}$		$\sqrt{dp}^{(3)}$
over	to	upper	lower	upper	lower	max.
-	10	+15	0	+15	0	10
10	18	+18	0	+18	0	10
18	30	+21	0	+21	0	13
30	50	+25	0	+25	0	15
50	80	+30	0	+30	0	19
80	120	+35	0	+35	0	25
120	180	+40	0	+40	0	31
180	250	+46	0	+46	0	38
250	315	+52	0	+52	0	44
315	400	+57	0	+57	0	50
400	500	+63	0	+63	0	56

- 1) Single plane mean bore diameter deviation at smallest theoretical opening.
- 2) Mean diameter deviation of large diameter less mean diameter deviation from small diameter.
- 3) Bore diameter variation in a single radial plane

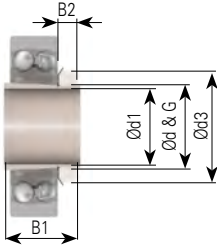

Taper 1:12

Part number	Principal dimensions						Weight	Accessories included	
	d1	d	d3	B1	B2	G		Locking Nut	Locking Device
	mm						Kg	Part number	Part number
H 204	17	20	32	24	7	M 20x1	0,04	KM 4	MB 4
H 2304	17	20	32	31	7	M 20x1	0,05	KM 4	MB 4
H 304	17	20	32	28	7	M 20x1	0,04	KM 4	MB 4
H 205	20	25	38	26	8	M 25x1,5	0,07	KM 5	MB 5
H 2305	20	25	38	35	8	M 25x1,5	0,09	KM 5	MB 5
H 305	20	25	38	29	8	M 25x1,5	0,07	KM 5	MB 5
H 206	25	30	45	27	8	M 30x1,5	0,01	KM 6	MB 6
H 2306	25	30	45	38	8	M 30x1,5	0,13	KM 6	MB 6
H 306	25	30	45	31	8	M 30x1,5	0,11	KM 6	MB 6
H 207	30	35	52	29	9	M 35x1,5	0,12	KM 7	MB 7
H 2307	30	35	52	43	9	M 35x1,5	0,16	KM 7	MB 7
H 307	30	35	52	35	9	M 35x1,5	0,14	KM 7	MB 7
HE 308	31,75	40	58	36	10	M 40x1,5	0,22	KM 8	MB 8
H 208	35	40	58	31	10	M 40x1,5	0,17	KM 8	MB 8
H 2308	35	40	58	46	10	M 40x1,5	0,22	KM 8	MB 8
H 308	35	40	58	36	10	M 40x1,5	0,19	KM 8	MB 8
H 209	40	45	65	33	11	M 45x1,5	0,23	KM 9	MB 9
H 2309	40	45	65	50	11	M 45x1,5	0,28	KM 9	MB 9
H 309	40	45	65	39	11	M 45x1,5	0,25	KM 9	MB 9
H 210	45	50	70	35	12	M 50x1,5	0,27	KM 10	MB 10
H 2310	45	50	70	55	12	M 50x1,5	0,36	KM 10	MB 10
H 310	45	50	70	42	12	M 50x1,5	0,30	KM 10	MB 10
H 211	50	55	75	37	12,5	M 55x2	0,31	KM 11	MB 11
H 2311	50	55	75	59	12,5	M 55x2	0,42	KM 11	MB 11
H 311	50	55	75	45	12,5	M 55x2	0,34	KM 11	MB 11
H 212	55	60	80	38	13	M 60x2	0,35	KM 12	MB 12
H 2312	55	60	80	62	13	M 60x2	0,48	KM 12	MB 12
H 312	55	60	80	47	13	M 60x2	0,39	KM 12	MB 12
H 213	60	65	85	40	14	M 65x2	0,40	KM 13	MB 13
H 2313	60	65	85	65	14	M 65x2	0,56	KM 13	MB 13
H 313	60	65	85	50	14	M 65x2	0,46	KM 13	MB 13
H 214	60	70	92	41	14	M 70x2	0,59	KM 14	MB 14
H 2314	60	70	92	68	14	M 70x2	0,90	KM 14	MB 14
H 314	60	70	92	52	14	M 70x2	0,72	KM 14	MB 14
H 215	65	75	98	43	15	M 75x2	0,71	KM 15	MB 15

Accessories

DATA TABLE - ADAPTER SLEEVE

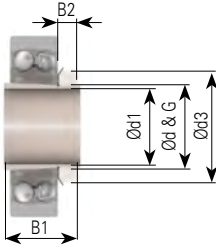

Part number	Principal dimensions						Weight	Accessories included	
	d1	d	d3	B1	B2	G		Locking Nut	Locking Device
	mm						Kg	Part number	Part number
H 2315	65	75	98	73	15	M 75x2	1,05	KM 15	MB 15
H 315	65	75	98	55	15	M 75x2	0,83	KM 15	MB 15
H 216	70	80	105	46	17	M 80x2	0,88	KM 16	MB 16
H 2316	70	80	105	78	17	M 80x2	1,28	KM 16	MB 16
H 316	70	80	105	59	17	M 80x2	1,03	KM 16	MB 16
H 217	75	85	110	50	18	M 85x2	1,02	KM 17	MB 17
H 2317	75	85	110	82	18	M 85x2	1,45	KM 17	MB 17
H 317	75	85	110	63	18	M 85x2	1,18	KM 17	MB 17
H 218	80	90	120	52	18	M 90x2	1,19	KM 18	MB 18
H 2318	80	90	120	86	18	M 90x2	1,69	KM 18	MB 18
H 318	80	90	120	65	18	M 90x2	1,37	KM 18	MB 18
H 219	85	95	125	55	19	M 95x2	1,37	KM 19	MB 19
H 2319	85	95	125	90	19	M 95x2	1,92	KM 19	MB 19
H 319	85	95	125	68	19	M 95x2	1,56	KM 19	MB 19
H 220	90	100	130	58	20	M 100x2	1,49	KM 20	MB 20
H 2320	90	100	130	97	20	M 100x2	2,15	KM 20	MB 20
H 3120	90	100	130	76	20	M 100x2	1,80	KM 20	MB 20
H 320	90	100	130	71	20	M 100x2	1,69	KM 20	MB 20
H 221	95	105	140	60	20	M 105x2	1,72	KM 21	MB 21
H 321	95	105	140	74	20	M 105x2	1,95	KM 21	MB 21
H 222	100	110	145	63	21	M 110x2	1,93	KM 22	MB 22
H 2322	100	110	145	105	21	M 110x2	2,74	KM 22	MB 22
H 3122	100	110	145	81	21	M 110x2	2,25	KM 22	MB 22
H 322	100	110	145	77	21	M 110x2	2,18	KM 22	MB 22
H 3024	110	120	145	72	22	M 120x2	1,93	KML 24	MBL 24
H 2324	110	120	155	112	22	M 120x2	3,19	KM 24	MB 24
H 3124	110	120	155	88	22	M 120x2	2,64	KM 24	MB 24
H 3026	115	130	155	80	23	M 130x2	2,85	KML 26	MBL 26
H 2326	115	130	165	121	23	M 130x2	4,60	KM 26	MB 26
H 3126	115	130	165	92	23	M 130x2	3,66	KM 26	MB 26
H 3028	125	140	165	82	24	M 140x2	3,16	KML 28	MBL 28
H 2328	125	140	180	131	24	M 140x2	5,55	KM 28	MB 28
H 3128	125	140	180	97	24	M 140x2	4,34	KM 28	MB 28
H 3030	135	150	180	87	26	M 150x2	3,89	KML 30	MBL 30
H 2330	135	150	195	139	26	M 150x2	6,63	KM 30	MB 30



Taper 1:12

Part number	Principal dimensions						Weight	Accessories included	
	d1	d	d3	B1	B2	G		Locking Nut	Locking Device
	mm						Kg	Part number	Part number
H 3130	135	150	195	111	26	M 150x2	5,52	KM 30	MB 30
H 3032	140	160	190	93	27,5	M 160x3	5,21	KML 32	MBL 32
H 2332	140	160	210	147	28	M 160x3	9,14	KM 32	MB 32
H 3132	140	160	210	119	28	M 160x3	7,67	KM 32	MB 32
H 3034	150	170	200	101	28,5	M 170x3	5,99	KML 34	MBL 34
H 2334	150	170	220	154	29	M 170x3	10,20	KM 34	MB 34
H 3134	150	170	220	122	29	M 170x3	8,38	KM 34	MB 34
H 3036	160	180	210	109	29,5	M 180x3	6,83	KML 36	MBL 36
H 3036 OH	160	180	210	109	29,5	M 180x3	6,70	KML 36	MBL 36
H 3936	160	180	210	87	29,5	M 180x3	5,70	KML 36	MBL 36
H 2336	160	180	230	161	30	M 180x3	11,30	KM 36	MB 36
H 2336 OH	160	180	230	161	30	M 180x3	11	KM 36	MB 36
H 3136	160	180	230	131	30	M 180x3	9,50	KM 36	MB 36
H 3136 OH	160	180	230	131	30	M 180x3	9,15	KM 36	MB 36
H 3038	170	190	220	112	30,5	M 190x3	7,45	KML 38	MBL 38
H 3038 OH	170	190	220	112	30,5	M 190x3	7,25	KM 38	MBL 38
H 3938	170	190	220	89	30,5	M 190x3	6,19	KML 38	MBL 38
H 2338	170	190	240	169	31	M 190x3	12,60	KM 38	MB 38
H 2338 OH	170	190	240	169	31	M 190x3	12	KM 38	MB 38
H 3138	170	190	240	141	31	M 190x3	10,80	KM 38	MB 38
H 3138 OH	170	190	240	141	31	M 190x3	10,50	KM 38	MB 38
H 3040	180	200	240	120	31,5	M 200x3	9,19	KML 40	MBL 40
H 3040 OH	180	200	240	120	31,5	M 200x3	8,90	KML 40	MBL 40
H 3940	180	200	240	98	31,5	M 200x3	7,89	KML 40	MBL 40
H 2340	180	200	250	176	32	M 200x3	13,90	KM 40	MB 40
H 2340 OH	180	200	250	176	32	M 200x3	13,50	KM 40	MB 40
H 3140	180	200	250	150	32	M 200x3	12,10	KM 40	MB 40
H 3140 OH	180	200	250	150	32	M 200x3	12	KM 40	MB 40
H 3044	200	220	260	126	30	Tr 220x4	10,30	HM 3044	MS 3044
H 3044 OH	200	220	260	126	30	Tr 220x4	9,90	HM 3044	MS 3044
H 3944	200	220	260	96	30	Tr 220x4	8,16	HM 3044	MS 3044
H 2344	200	220	280	186	35	Tr 220x4	17	HM 44T	MB 44
H 2344 OH	200	220	280	186	35	Tr 220x4	17	HM 44T	MB 44
H 3144	200	220	280	161	35	Tr 220x4	15	HM 44T	MB 44
H 3144 OH	200	220	280	161	35	Tr 200x3	15	HM 44T	MB 44

Accessories

DATA TABLE - ADAPTER SLEEVE

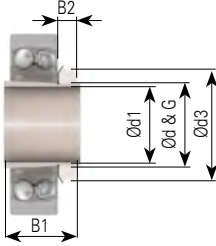

Part number	Principal dimensions						Weight	Accessories included	
	d1	d	d3	B1	B2	G		Locking Nut	Locking Device
	mm						Kg	Part number	Part number
H 3048	220	240	290	133	34	Tr 240x4	13,2	HM 3048	MS 3048
H 3048 OH	220	240	290	133	34	Tr 240x4	12	HM 3048	MS 3052-48
H 3948	220	240	290	101	34	Tr 240x4	11	HM 3048	MS 3048
H 2348	220	240	300	199	37	Tr 240x4	20	HM 48T	MB 48
H 2348 OH	220	240	300	199	37	Tr 240x4	19	HM 48T	MB 48
H 3148	220	240	300	172	37	Tr 240x4	17,6	HM 48T	MB 48
H 3148 OH	220	240	300	172	37	Tr 240x4	16,5	HM 48T	MB 48
H 3052	240	260	310	145	34	Tr 260x4	15,3	HM 3052	MS 3052
H 3052 OH	240	260	310	145	34	Tr 260x4	13,5	HM 3052	MS 3052-48
H 3952	240	260	310	116	34	Tr 260x4	12,8	HM 3052	MS 3052
H 2352	240	260	330	211	39	Tr 260x4	24,5	HM 52T	MB 52
H 2352 OH	240	260	330	211	39	Tr 260x4	23	HM 52T	MB 52
H 3152	240	260	330	190	39	Tr 260x4	22,3	HM 52T	MB 52
H 3152 OH	240	260	330	190	39	Tr 260x4	21	HM 52T	MB 52
H 3056	260	280	330	152	38	Tr 280x4	17,7	HM 3056	MS 3056
H 3056 OH	260	280	330	152	38	Tr 280x4	16	HM 3056	MS 3056
H 3156 OH	260	280	330	195	41	Tr 280x4	19,3	HM 3056	MS 3056
H 3956	260	280	330	121	38	Tr 280x4	15,3	HM 3056	MS 3056
H 2356	260	280	350	224	41	Tr 280x4	28,4	HM 56T	MB 56
H 2356 OH	260	280	350	224	41	Tr 280x4	27	HM 56T	MB 56
H 3156	260	280	350	195	41	Tr 280x4	25,1	HM 56T	MB 56
H 3060	280	300	360	168	42	Tr 300x4	22,8	HM 3060	MS 3060
H 3060 OH	280	300	360	168	42	Tr 300x4	20,5	HM 3060	MS 3060
H 3960	280	300	360	140	42	Tr 300x4	20	HM 3060	MS 3060
H 3160	280	300	380	208	40	Tr 300x4	30,2	HM 3160	MS 3160
H 3160 OH	280	300	380	208	40	Tr 300x4	29	HM 3160	MS 3160
H 3260	280	300	380	240	40	Tr 300x4	34,1	HM 3160	MS 3160
H 3260 OH	280	300	380	240	40	Tr 300x4	32	HM 3160	MS 3160
H 3064	300	320	380	171	42	Tr 320x5	24,6	HM 3064	MS 3064
H 3064 OH	300	320	380	171	42	Tr 320x5	22	HM 3064	MS 3068-64
H 3964	300	320	380	140	42	Tr 320x5	21,5	HM 3064	MS 3064
H 3164	300	320	400	226	42	Tr 320x5	34,9	HM 3164	MS 3164
H 3164 OH	300	320	400	226	42	Tr 320x5	32	HM 3164	MS 3164
H 3264	300	320	400	258	42	Tr 320x5	39,3	HM 3164	MS 3164
H 3264 OH	300	320	400	258	42	Tr 320x5	35	HM 3164	MS 3164



Taper 1:12

Part number	Principal dimensions						Weight	Accessories included	
	d1	d	d3	B1	B2	G		Locking Nut	Locking Device
	mm						Kg	Part number	Part number
H 3068	320	340	400	187	45	Tr 340x5	28,7	HM 3068	MS 3068
H 3068 OH	320	340	400	187	45	Tr 340x5	27	HM 3068	MS 3068-64
H 3968	320	340	400	144	45	Tr 340x5	24,5	HM 3068	MS 3068
H 3168	320	340	440	254	55	Tr 340x5	50	HM 3168	MS 3168
H 3168 OH	320	340	440	254	55	Tr 340x5	50	HM 3168	MS 3172-68
H 3268	320	340	440	288	55	Tr 340x5	54,6	HM 3168	MS 3168
H 3268 OH	320	340	440	288	55	Tr 340x5	51,5	HM 3168	MS 3172-68
H 3072	340	360	420	188	45	Tr 360x5	30,5	HM 3072	MS 3072
H 3072 OH	340	360	420	188	45	Tr 360x5	29	HM 3072	MS 3072
H 3972	340	360	420	144	45	Tr 360x5	25,2	HM 3072	MS 3072
H 3172	340	360	460	259	58	Tr 360x5	56	HM 3172	MS 3172
H 3172 OH	340	360	460	259	58	Tr 360x5	56	HM 3172	MS 3172-68
H 3272	340	360	460	299	58	Tr 360x5	60,6	HM 3172	MS 3172
H 3272 OH	340	360	460	299	58	Tr 360x5	60,5	HM 3172	MS 3172-68
H 3076	360	380	450	193	48	Tr 380x5	35,8	HM 3076	MS 3076
H 3076 OH	360	380	450	193	48	Tr 380x5	35,5	HM 3076	MS 3080-76
H 3976	360	380	450	164	48	Tr 380x5	31,5	HM 3076	MS 3076
H 3176	360	380	490	264	60	Tr 380x5	61,7	HM 3176	MS 3176
H 3176 OH	360	380	490	264	60	Tr 380x5	61,5	HM 3176	MS 3176
H 3276	360	380	490	310	60	Tr 380x5	69,6	HM 3176	MS 3176
H 3276 OH	360	380	490	310	60	Tr 380x5	69,5	HM 3176	MS 3176
H 3080	380	400	470	210	52	Tr 400x5	41,3	HM 3080	MS 3080
H 3080 OH	380	400	470	210	52	Tr 400x5	40	HM 3080	MS 3080-76
H 3980	380	400	470	168	52	Tr 400x5	35	HM 3080	MS 3080
H 3180	380	400	520	272	62	Tr 400x5	73	HM 3180	MS 3180
H 3180 OH	380	400	520	272	62	Tr 400x5	73	HM 3180	MS 3184-80
H 3280	380	400	520	328	62	Tr 400x5	81	HM 3180	MS 3180
H 3280 OH	380	400	520	328	62	Tr 400x5	87	HM 3180	MS 3184-80
H 3084	400	420	490	212	52	Tr 420x5	43,7	HM 3084	MS 3084
H 3084 OH	400	420	490	212	52	Tr 420x5	47	HM 3084	MS 3084
H 3984	400	420	490	168	52	Tr 420x5	36,6	HM 3084	MS 3084
H 3184	400	420	540	304	70	Tr 420x5	84,2	HM 3184	MS 3184
H 3184 OH	400	420	540	304	70	Tr 420x5	80	HM 3184	MS 3184-80
H 3284	400	420	540	352	70	Tr 420x5	96	HM 3184	MS 3184
H 3284 OH	400	420	540	352	70	Tr 420x5	96	HM 3184	MS 3184-80
H 3088	410	440	520	228	60	Tr 440x5	65,2	HM 3088	MS 3088

Accessories

DATA TABLE - ADAPTER SLEEVE

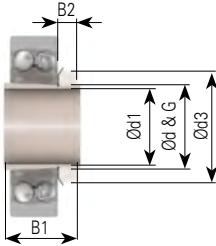

Taper 1:12

Part number	Principal dimensions						Weight	Accessories included	
	d1	d	d3	B1	B2	G		Locking Nut	Locking Device
	mm						Kg	Part number	Part number
H 3088 OH	410	440	520	228	60	Tr 440X5	65	HM 3088	MS 3092-88
H 3988	410	440	520	189	60	Tr 440x5	58	HM 3088	MS 3088
H 3188	410	440	560	307	70	Tr 440X5	104	HM 3188	MS 3188
H 3188 OH	410	440	560	307	70	Tr 440X5	95	HM 3188	MS 3192-88
H 3288	410	440	560	361	70	Tr 440X5	118	HM 3188	MS 3188
H 3288 OH	410	440	560	361	70	Tr 440X5	117	HM 3188	MS 3192-88
H 3092	430	460	540	234	60	Tr 460X5	71	HM 3092	MS 3092
H 3092 OH	430	460	540	234	60	Tr 460X5	71	HM 3092	MS 3092-88
H 3992	430	460	540	189	60	Tr 460x5	60	HM 3092	MS 3092
H 3192	430	460	580	326	75	Tr 460X5	116	HM 3192	MS 3192
H 3192 OH	430	460	580	326	75	Tr 460X5	119	HM 3192	MS 3192-88
H 3292	430	460	580	382	75	Tr 460X5	134	HM 3192	MS 3192
H 3292 OH	430	460	580	382	75	Tr 460X5	134	HM 3192	MS 3192-88
H 3096	450	480	560	237	60	Tr 480X5	75	HM 3096	MS 30/96
H 3096 OH	450	480	560	237	60	Tr 480X5	75	HM 3096	MS 30/500-96
H 3996	450	480	560	200	60	Tr 480x5	66	HM 3096	MS 30/96
H 3196	450	480	620	335	75	Tr 480X5	135	HM 3196	MS 3196
H 3196 OH	450	480	620	335	75	Tr 480X5	135	HM 3196	MS 3196
H 3296	450	480	620	397	75	Tr 480X5	153	HM 3196	MS 3196
H 3296 OH	450	480	620	397	75	Tr 480X5	153	HM 3196	MS 3196
H 30/500	470	500	580	247	68	Tr 500x5	82	HM 30/500	MS 30/500
H 30/500 OH	470	500	580	247	68	Tr 500x5	82	HM 30/500	MS 30/500-96
H 39/500	470	500	580	208	68	Tr 500x5	74,3	HM 30/500	MS 30/500
H 31/500	470	500	630	356	80	Tr 500x5	145	HM 31/500	MS 31/500
H 31/500 OH	470	500	630	356	80	Tr 500x5	145	HM 31/500	MS 31/500
H 32/500	470	500	630	428	80	Tr 500x5	166	HM 31/500	MS 31/500
H 32/500 OH	470	500	630	428	80	Tr 500x5	170	HM 31/500	MS 31/500
H 30/530	500	530	630	265	68	Tr 530x6	105	HM 30/530	MS 30/530
H 30/530 OH	500	530	630	265	68	Tr 530x6	105	HM 30/530	MS 30/600-530
H 39/530	500	530	630	216	68	Tr 530x6	87,9	HM 30/530	MS 30/530
H 39/530 OH	500	530	630	216	68	Tr 530x6	87,9	HM 30/530	MS 30/600-530
H 31/530	500	530	670	364	80	Tr 530x6	161	HM 31/530	MS 31/530
H 32/530	500	530	670	447	80	Tr 530x6	192	HM 31/530	MS 31/530
H 30/560	530	560	650	282	75	Tr 560x6	112	HM 30/560	MS 30/560
H 30/560 OH	530	560	650	282	75	Tr 560x6	112	HM 30/560	MS 30/560
H 39/560	530	560	650	227	75	Tr 560x6	95	HM 30/560	MS 30/560



Taper 1:12

Part number	Principal dimensions						Weight	Accessories included	
	d1	d	d3	B1	B2	G		Locking Nut	Locking Device
	mm						Kg	Part number	Part number
H 39/560 OH	530	560	650	227	75	Tr 560x6	95	HM 30/560	MS 30/560
H 31/560	530	560	710	377	85	Tr 560x6	185	HM 31/560	MS 31/560
H 32/560	530	560	710	462	85	Tr 560x6	219	HM 31/560	MS 31/560
H 30/600	560	600	700	289	75	Tr 600x6	147	HM 30/600	MS 30/600
H 30/600 OH	560	600	700	289	75	Tr 600x6	147	HM 30/600	MS 30/600-530
H 39/600	560	600	700	239	75	Tr 600x6	127	HM 30/600	MS 30/600
H 39/600 OH	560	600	700	239	75	Tr 600x6	127	HM 30/600	MS 30/600-530
H 31/600	560	600	750	399	85	Tr 600x6	234	HM 31/600	MS 31/600
H 32/600	560	600	750	487	85	Tr 600x6	278	HM 31/600	MS 31/600
H 30/630	600	630	730	301	75	Tr 630x6	138	HM 30/630	MS 30/630
H 30/630 OH	600	630	730	301	75	Tr 630x6	138	HM 30/630	MS 30/630
H 39/630	600	630	730	254	75	Tr 630x6	120	HM 30/630	MS 30/630
H 39/630 OH	600	630	730	254	75	Tr 630x6	124	HM 30/630	MS 30/630
H 31/630	600	630	800	424	95	Tr 630x6	254	HM 31/630	MS 31/630
H 32/630	600	630	800	521	95	Tr 630x6	300	HM 31/630	MS 31/630
H 30/670	630	670	780	324	80	Tr 670x6	191	HM 30/670	MS 30/670
H 30/670 OH	630	670	780	324	80	Tr 670x6	190	HM 30/670	MS 30/670
H 39/670	630	670	780	264	80	Tr 670x6	163	HM 30/670	MS 30/670
H 39/670 OH	630	670	780	264	80	Tr 670x6	162	HM 30/670	MS 30/670
H 31/670	630	670	850	456	106	Tr 670x6	340	HM 31/670	MS 31/670
H 32/670	630	670	850	558	106	Tr 670x6	401	HM 31/670	MS 31/670
H 30/710	670	710	830	342	90	Tr 710x7	223	HM 30/710	MS 30/710
H 30/710 OH	670	710	830	342	90	Tr 710x7	228	HM 30/710	MS 30/710
H 39/710	670	710	830	286	90	Tr 710x7	196	HM 30/710	MS 30/710
H 39/710 OH	670	710	830	286	90	Tr 710x7	183	HM 30/710	MS 30/710
H 31/710	670	710	900	467	106	Tr 710x7	378	HM 31/710	MS 31/710
H 32/710	670	710	900	572	106	Tr 710x7	444	HM 31/710	MS 31/710
H 30/750	710	750	870	356	90	Tr 750x7	246	HM 30/750	MS 30/750
H 39/750	710	750	870	291	90	Tr 750x7	211	HM 30/750	MS 30/750
H 31/750	710	750	950	493	112	Tr 750x7	451	HM 31/750	MS 31/750
H 32/750	710	750	950	603	112	Tr 750x7	507	HM 31/750	MS 31/750
H 30/800	750	800	920	366	90	Tr 800x7	300	HM 30/800	MS 30/800
H 39/800	750	800	920	303	90	Tr 800x7	259	HM 30/800	MS 30/800
H 31/800	750	800	1000	505	112	Tr 800x7	515	HM 31/800	MS 31/800
H 32/800	750	800	1000	618	112	Tr 800x7	610	HM 31/800	MS 31/800
H 30/900 OH	850	900	1030	400	100	Tr 900x7	387	HM 30/900	MS 30/900-850

Accessories

DATA TABLE - WITHDRAWAL SLEEVE

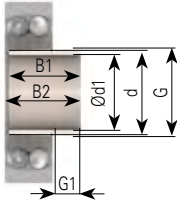

Taper 1:12

Part number	Principal dimensions						Weight	Accessories included	
	d1	d	B1	B2	G	G1		Dismounting Nut	Hydraulic Nut
	mm						Kg	Part number	Part number
AH 308	35	40	29	32	M 45x1,5	6	0,09	KM 9	HMV 9E
AH 2308	35	40	40	43	M 45x1,5	7	0,13	KM 9	HMV 9E
AH 309	40	45	31	34	M 50x1,5	6	0,11	KM 10	HMV 10E
AH 2309	40	45	44	47	M 50x1,5	7	0,16	KM 10	HMV 10E
AH 310	45	50	35	38	M 60x20	7	0,16	KM 12	HMV 12E
AH 2310	45	50	50	53	M 60x2	8	0,24	KM 12	HMV 12E
AH 311	50	55	37	40	M 65x2	7	0,19	KM 13	HMV 13E
AH 2311	50	55	54	57	M 65x2	9	0,29	KM 13	HMV 13E
AH 312	55	60	40	43	M 70x2	8	0,22	KM 14	HMV 14E
AH 2312	55	60	57	60	M 70x2	10	0,34	KM 14	HMV 14E
AH 313	60	65	42	45	M 75x2	8	0,25	KM 15	HMV 15E
AH 2313	60	65	61	64	M 75x2	12	0,40	KM 15	HMV 15E
AH 314	65	70	43	47	M 80x2	8	0,28	KM 16	HMV 16E
AH 2314	65	70	65	69	M 85x2	10	0,53	KM 17	HMV 17E
AH 315	70	75	45	49	M 85x2	8	0,31	KM 17	HMV 17E
AH 2315	70	75	69	53	M 90x2	12	0,61	KM 18	HMV 18E
AH 316	75	80	48	52	M 90x2	8	0,37	KM 18	HMV 18E
AH 2316	75	80	72	76	M 95x2	12	0,67	KM 19	HMV 19E
AH 317	80	85	52	56	M 100x2	9	0,48	KM 20	HMV 20E
AH 2317	80	85	75	79	M 100x2	13	0,75	KM 20	HMV 20E
AH 318	85	90	53	57	M 105x2	9	0,52	KM 21	HMV 21E
AH 2318	85	90	80	84	M 105x2	14	0,85	KM 21	HMV 21E
AH 319	90	95	57	61	M 110x2	10	0,59	KM 22	HMV 22E
AH 2319	90	95	85	89	M 110x2	15	0,98	KM 22	HMV 22E
AH 320	95	100	59	63	M 115x2	10	0,66	KM 23	HMV 23E
AH 2320	95	100	90	94	M 120x2	15	1,23	KM 24	HMV 24E
AH 322	100	110	63	67	M 130x2	12	1,26	KM 26	HMV 26E
AH 3122	100	110	68	72	M 125x2	11	1,28	KM 25	HMV 25E
AH 2322	100	110	98	102	M 130x2	16	2,11	KM 26	HMV 26E
AH 24122	105	110	82	91	M 115x2	13	0,71	KM 23	HMV 23E
AH 3024	110	120	60	64	M 130x2	13	1,15	KM 26	HMV 26E
AH 3124	110	120	75	79	M 140x2	12	1,67	KM 28	HMV 28E
AH 2324	110	120	105	109	M 140x2	17	2,47	KM 28	HMV 28E
AH 24024	115	120	73	82	M 125x2	13	0,70	KM 25	HMV 25E
AH 24124	115	120	93	102	M 130x2	13	1	KM 26	HMV 26E



Taper 1:12

Part number	Principal dimensions						Weight	Accessories included	
	d1	d	B1	B2	G	G1		Dismounting Nut	Hydraulic Nut
	mm						Kg	Part number	Part number
AH 3026	120	130	67	71	M 140x2	14	1,41	KM 28	HMV 28E
AH 3126	120	130	78	82	M 150x2	12	1,87	KM 30	HMV 30E
AH 2326	120	130	115	119	M 150x2	19	3,02	KM 30	HMV 30E
AH 24026	125	130	83	93	M 135x2	14	0,88	KM 27	HMV 27E
AH 24126	125	130	94	104	M 140x2	14	1,15	KM 28	HMV 28E
AH 3028	130	140	68	73	M 150x2	14	1,55	KM 30	HMV 30E
AH 3128	130	140	83	88	M 160x3	14	2,21	KM 32	HMV 32E
AH 2328	130	140	125	130	M 160x3	20	3,60	KM 32	HMV 32E
AH 24028	135	140	83	93	M 145x2	14	0,95	KM 29	HMV 29E
AH 24128	135	140	99	109	M 150x2	14	1,30	KM 30	HMV 30E
AH 3030	140	150	72	5	M 160x3	15	1,76	KM 32	HMV 32E
AH 3130	140	150	96	101	M 170x3	15	2,70	KM 34	HMV 34E
AH 2330	140	150	135	140	M 170x3	24	4,22	KM 34	HMV 34E
AH 24030	145	150	90	101	M 155x3	15	1,05	KM 31	HMV 31E
AH 24130	145	150	115	126	M 160x3	15	1,55	KM 32	HMV 32E
AH 3032	150	160	77	82	M 170x3	16	2,06	KM 34	HMV 34E
AH 24032	150	160	95	106	M 170x3	15	2,30	KM 34	HMV 34E
AH 3132	150	160	103	108	M 180x3	16	3,21	KM 36	HMV 36E
AH 24132	150	160	124	135	M 170x3	15	3	KM 34	HMV 34E
AH 3232	150	160	124	130	M 180x3	20	4,08	KM 36	HMV 36E
AH 2332	150	160	140	146	M 180x3	24	4,72	KM 36	HMV 36E
AH 3034	160	170	85	90	M 180x3	17	2,43	KM 36	HMV 36E
AH 3134	160	170	104	109	M 190x3	16	3,40	KM 38	HMV 38E
AH 24034	160	170	106	117	M 180x3	16	2,70	KM 36	HMV 36E
AH 24134	160	170	125	136	M 180x3	16	3,25	KM 36	HMV 36E
AH 3234	160	170	134	140	M 190x3	24	4,80	KM 38	HMV 38E
AH 2334	160	170	146	152	M 190x3	24	5,25	KM 38	HMV 38E
AH 3136	160	180	116	122	M 200x3	19	4,22	KM 40	HMV 40E
AH 3036	170	180	92	98	M 190x3	17	2,81	KM 38	HMV 38E
AH 3036 OH	170	180	92	98	M 190x3	17	2,80	KM 38	HMV 38E
AH 2236	170	180	105	110	M 200x3	17	3,73	KM 40	HMV 40E
AH 24036	170	180	116	127	M 190x3	16	3,20	KM 38	HMV 38E
AH 3136 OH	170	180	116	122	M 200x3	19	3,90	KM 38	HMV 38E
AH 24136	170	180	134	145	M 190x3	16	3,75	KM 38	HMV 38E
AH 3236	170	180	140	146	M 200x3	24	5,32	KM 40	HMV 40E

Accessories

DATA TABLE - WITHDRAWAL SLEEVE

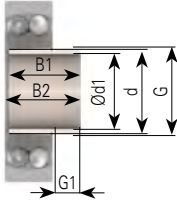

Taper 1:12

Part number	Principal dimensions						Weight	Accessories included	
	d1	d	B1	B2	G	G1		Dismounting Nut	Hydraulic Nut
	mm						Kg	Part number	Part number
AH 2326 OH	170	180	140	146	M 200x3	24	4,85	KM 38	HMV 38E
AH 2336	170	180	154	160	M 200x3	26	5,83	KM 40	HMV 40E
AH 2336 OH	170	180	154	160	M 200x3	26	6,05	KM 40	HMV 40E
AH 3038	180	190	96	102	Tr 205x4	18	3,32	HML 41T	HMV 41E
AH 3038 OH	180	190	96	102	Tr 205x4	18	3,30	HML 41T	HMV 40E
AH 2238	180	190	112	117	Tr 210x4	18	4,25	HM 42T	HMV 42E
AH 24038	180	190	118	131	M 200x3	18	3,55	KM 40	HMV 40E
AH 3138	180	190	125	131	Tr 210x4	20	4,89	HM 42T	HMV 42E
AH 3138 OH	180	190	125	131	Tr 210x4	20	4,50	HM 42T	HMV 40E
AH 3238	180	190	145	152	Tr 210x4	25	5,90	HM 42T	HMV 42E
AH 3238 OH	180	190	145	152	Tr 210x4	25	5,90	HM 42T	HMV 40E
AH 24138	180	190	146	159	M 200x3	18	4,45	KM 40	HMV 40E
AH 2338	180	190	160	167	Tr 210x4	26	6,63	HM 42T	HMV 42E
AH 3338 OH	180	190	160	167	Tr 210x4	26	6,70	HM 42T	HMV 42E
AH 3940	190	200	77	83	Tr 210x4	16	2,62	HM 42T	HMV 40E
AH 3040	190	200	102	108	Tr 215x4	19	3,80	HM L43T	HMV 43E
AH 3040 OH	190	200	102	108	Tr 215x4	19	3,70	HM 42T	HMV 42E
AH 2240	190	200	118	123	Tr 220x4	19	4,68	HM 44T	HMV 44E
AH 24040	190	200	127	140	Tr 210x4	18	4	HM 42T	HMV 42E
AH 3140	190	200	134	140	Tr 220x4	21	5,49	HM 44T	HMV 44E
AH 3140 OH	190	200	134	140	Tr 220x4	21	5,65	HM 3044	HMV 44E
AH 3240	190	200	153	160	Tr 220x4	25	6,68	HM 44T	HMV 44E
AH 3240 OH	190	200	153	160	Tr 220x4	25	6,60	HM 3044	HMV 44E
AH 24140 OH	190	200	158	171	Tr 210x4	18	5,05	HM 42T	HMV 42E
AH 2340	190	200	170	177	Tr 220x4	30	7,54	HM 44T	HMV 44E
AH 2340 OH	190	200	170	177	Tr 220x4	30	7,60	HM 44T	HMV 44E
AH 3044	200	220	111	117	Tr 235x4	20	7,40	HM L47T	HMV 47E
AH 3044 OH	200	220	111	117	Tr 235x4	20	7,30	HM 46T	HMV 46E
AH 2244	200	220	130	136	Tr 240x4	20	9,10	HM 48T	HMV 48E
AH 3144	200	220	145	151	Tr 240x4	23	10,40	HM 48T	HMV 48E
AH 3144 OH	200	220	145	151	Tr 240x4	23	9,30	HM 3048	HMV 48E
AH 24144 OH	200	220	170	184	Tr 230x4	20	10,50	HM 46T	HMV 46E
AH 2344	200	220	181	189	Tr 240x4	30	13,50	HM 48T	HMV 48E
AH 2344 OH	200	220	181	189	Tr 240x4	30	13,50	HM 48T	HMV 48E
AH 3048	220	240	116	123	Tr 260x4	21	8,75	HM 52T	HMV 52E



Taper 1:12

Part number	Principal dimensions						Weight	Accessories included	
	d1	d	B1	B2	G	G1		Dismounting Nut	Hydraulic Nut
	mm						Kg	Part number	Part number
AH 3048 OH	220	240	116	123	Tr 260x4	21	7,95	HM 3052	HMV 52E
AH 2248	220	240	144	150	Tr 260x4	21	11,1	HM 52T	HMV 52E
AH 2248 OH	220	240	144	150	Tr 260x4	21	11,5	HM 3052	HMV 52E
AH 3148	220	240	154	161	Tr 260x4	25	12	HM 52T	HMV 52E
AH 3148 OH	220	240	154	161	Tr 260x4	25	12	HM 3052	HMV 52E
AH 2348	220	240	189	197	Tr 260x4	30	15,5	HM 52T	HMV 52E
AH 2348 OH	220	240	189	197	Tr 260x4	30	14	HM 52T	HMV 52E
AH 3052	240	260	128	135	Tr 280x4	23	10,7	HM 56T	HMV 56E
AH 3052 H	240	260	128	135	Tr 280x4	23	9,6	HM 3056	HMV 56E
AH 3052 OH	240	260	128	135	Tr 280x4	23	9,6	HM 3056	HMV 56E
AH 3952 G	240	260	155	100	Tr 280x4	18	7,7	HM 58T	HMV 58E
AH 2252	240	260	155	161	Tr 290x4	23	14,0	HM 58T	HMV 58E
AH 2252 OH	240	260	155	161	Tr 290x4	23	12,5	HM 58T	HMV 58E
AH 3152	240	260	172	179	Tr 290x4	26	16,2	HM 58T	HMV 58E
AH 3152 OH	240	260	172	179	Tr 290x4	26	15,5	HM 3056	HMV 56E
AH 2352	240	260	205	213	Tr 290x4	30	19,6	HM 58T	HMV 58E
AH 2352 OH	240	260	205	219	Tr 290x4	30	17,5	HM 58T	HMV 58E
AH 3056	260	280	131	139	Tr 300x4	24	12	HM 3060	HMV 60E
AH 3056 OH	260	280	131	139	Tr 300x4	24	11	HM 3060	HMV 60E
AH 2256	260	280	155	163	Tr 310x5	24	15,2	HM 62T	HMV 62E
AH 2256 OH	260	280	155	163	Tr 300x4	24	15	HM 3160	HMV 60E
AH 3156	260	280	175	183	Tr 310x5	28	17,5	HM 62T	HMV 62E
AH 3156 OH	260	280	175	183	Tr 310x5	28	17	HM 3160	HMV 60E
AH 24156 OH	260	280	202	219	Tr 300x4	22	16,3	HM 60T	HMV 60
AH 2356	260	280	212	220	Tr 310x5	30	17,1	HM 3160	HMV 60E
AH 2356 OH	260	280	212	220	Tr 310x5	30	19,5	HM 62T	HMV 62E
AH 3060	280	300	145	153	Tr 320x5	26	14,4	HM 3064	HMV 64E
AH 3060 OH	280	300	145	153	Tr 320x5	26	13	HM 3064	HMV 64E
AH 2260	280	300	170	178	Tr 330x5	26	18,1	HM 66T	HMV 66E
AH 2260 OH	280	300	170	178	Tr 330x5	26	18	HM 3164	HMV 64E
AH 3160	280	300	192	200	Tr 330x5	30	20,8	HM 66T	HMV 66E
AH 3160 OH	280	300	192	200	Tr 330x5	30	20,5	HM 3164	HMV 64E
AH 3260	280	300	228	236	Tr 330x5	34	26	HM 66T	HMV 66E
AH 3260 OH	280	300	228	236	Tr 330x5	34	23,5	HM 3164	HMV 64E
AH 3064	300	320	149	157	Tr 345x5	27	17	HM 3068	HMV 68E
AH 3064 OH	300	320	149	157	Tr 345x5	27	17	HM 3068	HMV 68E

Accessories

DATA TABLE - WITHDRAWAL SLEEVE

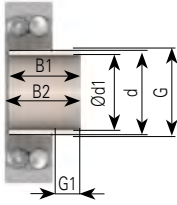

Taper 1:12

Part number	Principal dimensions						Weight	Accessories included	
	d1	d	B1	B2	G	G1		Dismounting Nut	Hydraulic Nut
	mm						Kg	Part number	Part number
AH 2264	300	320	180	190	Tr 350X5	27	20,2	HM 70T	HMV 70E
AH 2264 OH	300	320	180	190	Tr 350X5	27	20	HM 3168	HMV 68E
AH 3164	300	320	209	217	Tr 350X5	31	24,5	HM 70T	HMV 70E
AH 3164 OH	300	320	209	217	Tr 350X5	31	24,5	HM 3168	HMV 68E
AH 3264	300	320	246	254	Tr 350X5	36	30,6	HM 70T	HMV 70E
AH 3264 OH	300	320	246	254	Tr 350X5	36	27	HM 3168	HMV 68E
AH 3068	320	340	162	171	Tr 365X5	28	19	HM 3072	HMV 72E
AH 3068 OH	320	340	162	171	Tr 365X5	28	19	HM 3072	HMV 72E
AH 3168	320	340	225	234	Tr 370X5	33	29	HM 74T	HMV 74E
AH 3168 OH	320	340	225	234	Tr 370X5	33	28,5	HM 3172	HMV 72E
AH 3268	320	340	264	273	Tr 370X5	38	35,4	HM 74T	HMV 74E
AH 3268 OH	320	340	264	273	Tr 370X5	38	32	HM 3172	HMV 72E
AH 24168 OH	320	340	269	288	Tr 360X5	26	27,1	HM 72T	HMV 72
AH 3072	340	360	167	176	Tr 385X5	30	21	HM 3076	HMV 76E
AH 3072 OH	340	360	167	176	Tr 385X5	30	21	HM 3076	HMV 76E
AH 3172	340	360	229	238	Tr 400X5	33	30,5	HM 3180	HMV 80E
AH 3172 OH	340	360	229	238	Tr 400X5	35	30,5	HM 3176	HMV 76E
AH 24172 OH	340	360	269	289	Tr 380X5	26	30,8	HM 3176	HMV 76E
AH 3272	340	360	274	283	Tr 400X5	40	41,5	HM 3180	HMV 80E
AH 3272 OH	340	360	274	283	Tr 380X5	40	35,5	HM 3176	HMV 76E
AH 3076	360	380	170	180	Tr 410X5	31	22,5	HM 3080	HMV 80E
AH 3076 OH	360	380	170	180	Tr 410X5	31	22,5	HM 3080	HMV 80E
AH 3176	360	380	232	242	Tr 420X5	36	35,7	HM 3184	HMV 84E
AH 3176 OH	360	380	232	242	Tr 420X5	36	33	HM 3180	HMV 80E
AH 3276	360	380	284	294	Tr 420X5	42	45,6	HM 3184	HMV 84E
AH 3276 OH	360	380	284	294	Tr 420X5	42	42	HM 3180	HMV 80E
AH 3080	380	400	183	193	Tr 430X5	33	26	HM 3080	HMV 84E
AH 3080 OH	380	400	183	193	Tr 430X5	33	26	HM 3080	HMV 84E
AH 3180	380	400	240	250	Tr 440X5	38	39,5	HM 3188	HMV 88E
AH 3180 OH	380	400	240	250	Tr 440X5	38	36	HM 3184	HMV 84E
AH 3280	380	400	302	312	Tr 440X5	44	51,7	HM 3188	HMV 88E
AH 3280 OH	380	400	302	312	Tr 440X5	44	48	HM 3184	HMV 84E
AH 3084	400	420	186	196	Tr 450X5	34	28	HM 3088	HMV 88E
AH 3084 OH	400	420	186	196	Tr 450X5	34	28	HM 3088	HMV 88E
AH 3184	400	420	266	276	Tr 460X5	40	27,9	HM 3088	HMV 88E
AH 3184 OH	400	420	266	276	Tr 460X5	40	43	HM 3188	HMV 88E



Taper 1:12

Part number	Principal dimensions						Weight	Accessories included	
	d1	d	B1	B2	G	G1		Dismounting Nut	Hydraulic Nut
	mm						Kg	Part number	Part number
AH 3284	400	420	321	331	Tr 460X5	46	46,5	HM 3192	HMV 92E
AH 3284 OH	400	420	321	331	Tr 440X5	46	54,5	HM 3188	HMV 88E
AH 3088	420	440	194	205	Tr 470X5	35	31	HM 3092	HMV 92E
AH 3088 OH	420	440	194	205	Tr 470X5	35	31	HM 3092	HMV 92E
AH 3188	420	440	270	281	Tr 480X5	42	49,8	HM 3196	HMV 96E
AH 3188 OH	420	440	270	281	Tr 480X5	42	46	HM 3192	HMV 92E
AH 3288	420	440	330	341	Tr 460X5	48	64,5	HM 3192	HMV 92E
AH 3288 OH	420	440	330	341	Tr 460X5	48	64,5	HM 3192	HMV 92E
AH 3092	440	460	202	213	Tr 490X5	37	34	HM 3096	HMV 96E
AH 3092 OH	440	460	202	213	Tr 490X5	37	34	HM 3096	HMV 96E
AH 3192	440	460	285	296	Tr 510X6	43	51,5	HM 3196	HMV 96E
AH 3192 OH	440	460	285	296	Tr 510X6	43	51,5	HM 3196	HMV 96E
AH 3292	440	460	349	360	Tr 480X5	50	80	HM 3196	HMV 96E
AH 3292 OH	440	460	349	360	Tr 480X5	50	80	HM 3196	HMV 96E
AH 3996 OH	460	480	158	157	Tr 500X5	28	25,8	HM 31/500	HMV 100E
AH 3096	460	480	205	217	Tr 520X6	38	34	HM 30/500	HMV 100E
AH 3096 OH	460	480	205	217	Tr 520X6	38	34	HM 30/500	HMV 100E
AH 3196	460	480	295	307	Tr 530X6	45	63	HM 31/500	HMV 100E
AH 3196 OH	460	480	295	307	Tr 530X6	45	63	HM 31/500	HMV 100E
AH 3296	460	480	364	376	Tr 500X5	52	81	HM 31/500	HMV 100E
AH 3296 OH	460	480	364	376	Tr 500X5	52	81	HM 31/500	HMV 100E
AH 30/500	480	500	209	221	Tr 530X6	40	41	HM 30/530	HMV 106E
AH 30/500 OH	480	500	209	221	Tr 530X6	40	41	HM 30/530	HMV 106E
AH 31/500	480	500	313	325	Tr 530X6	47	66,5	HM 31/530	HMV 106E
AH 31/500 OH	480	500	313	325	Tr 530X6	47	66,5	HM 31/530	HMV 106E
AH 30/530	500	530	230	242	Tr 560X6	45	61,9	HM 30/560	HMV 112E
AH 30/530 OH	500	530	230	242	Tr 560X6	45	63,5	HM 30/560	HMV 112E
AH 31/530	500	530	325	337	Tr 560x6	53	93,4	HM 31/560	HMV 112E
AH 32/530	500	530	412	424	Tr 580x6	57	133	HM 116T	HMV 16E
AH 30/560	530	560	240	252	Tr 600X6	45	73,5	HM 30/600	HMV 120E
AH 30/560 OH	530	560	240	252	Tr 600X6	45	73,5	HM 30/600	HMV 120E
AH 31/560	530	560	335	347	Tr 600x6	55	108	HM 31/600	HMV 120E
AH 30/600	560	600	245	259	Tr 630X6	45	77	HM 30/630	HMV 126E
AH 30/600 OH	560	600	245	259	Tr 630X6	45	77	HM 30/630	HMV 126E
AH 30/630	600	630	258	272	Tr 670X6	46	89,7	HM 30/670	HMV 134E

Accessories

DATA TABLE - WITHDRAWAL SLEEVE

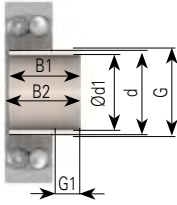

Taper 1:12

Part number	Principal dimensions						Weight	Accessories included	
	d1	d	B1	B2	G	G1		Dismounting Nut	Hydraulic Nut
	mm						Kg	Part number	Part number
AH 30/630 OH	600	630	258	272	Tr 670X6	46	88,5	HM 30/670	HMV 134E
AH 31/630	600	630	375	389	Tr 670x6	60	140	HM 31/670	HMV 134E
AH 32/630	600	630	475	489	Tr 680x6	63	191	HM 136T	HMV 36E
AH 30/670 OH	630	370	280	294	Tr 710X7	50	125	HM 30/710	HMV 142E
AH 30/670	630	670	280	294	Tr 710X7	50	127	HM 30/710	HMV 142E
AH 32/670	630	670	500	514	Tr 720x7	62	256	HM 144T	HMV 44E
AH 30/710	670	710	286	302	Tr 750X7	50	138	HM 30/750	HMV 150E
AH 30/710 OH	670	710	286	302	Tr 750X7	50	138	HM 30/750	HMV 150E
AH 32/710	670	710	500	516	Tr 760x7	65	282	HM 31/750	HMV 152E
AH 30/750	710	750	300	316	Tr 800x7	50	159	HM 30/800	HMV 160E
AH 31/750	710	750	425	441	Tr 800x7	60	238	HM 31/800	HMV 160E
AH 32/750	710	750	540	556	Tr 800x7	65	320	HM 31/800	HMV 160E
AH 30/800	750	800	308	326	Tr 850x7	50	204	HM 30/850	HMV 170E
AH 31/800	750	800	438	456	Tr 850x7	63	305	HM 31/850	HMV 170E
AH 32/800	750	800	550	568	Tr 850x7	67	401	HM 31/850	HMV 170E
AH 30/850	800	850	325	343	Tr 900x7	53	230	HM 30/900	HMV 180E
AH 31/850	800	850	462	480	Tr 900x7	62	345	HM 31/900	HMV 180E
AH 32/850	800	850	585	603	Tr 900x7	70	461	HM 31/900	HMV 180E
AH 30/900	850	900	335	355	Tr 950x8	55	253	HM 30/950	HMV 190E
AH 31/900	850	900	475	495	Tr 950x8	63	379	HM 31/950	HMV 190E
AH 32/900	850	900	585	605	Tr 950x8	70	489	HM 31/950	HMV 190E
AH 30/950	900	950	355	375	Tr 1000x8	55	285	HM 30/1000	HMV 200E
AH 31/950	900	950	500	520	Tr 1000x8	62	426	HM 31/1000	HMV 200E
AH 32/950	900	950	600	620	Tr 1000x8	70	533	HM 31/1000	HMV 200E

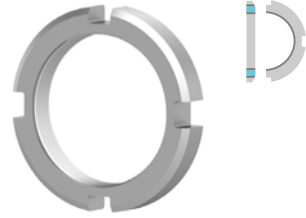
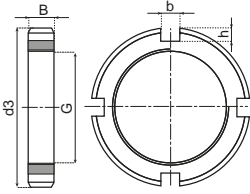

NUT	Principal dimensions				lock		Weight	Suitable for use with locking device type (not included)
	bore	outer	width	thread	width	depth		
	mm							
Part number	d	d3	B	G	b	h	-	
KM 0	10	18	4	M 10x0.75	4	3	0,004	MB 0
KM 1	12	22	4	M 12x1	4	3	0,006	MB 1
KM 2	15	25	5	M 15x1	5	4	0,009	MB 2
KM 3	17	28	5	M 17x1	5	4	0,015	MB 3
KM 4	20	32	6	M 20x1	6	4	0,025	MB 4
KM 5	25	38	7	M 25x1.5	7	5	0,028	MB 5
KM 6	30	45	7	M 30x1.5	7	5	0,039	MB 6
KM 7	35	52	8	M 35x1.5	8	5	0,059	MB 7
KM 8	40	58	9	M 40x1.5	9	6	0,078	MB 8
KM 9	45	65	10	M 45x1.5	10	6	0,11	MB 9
KM 10	50	70	11	M 50x1.5	11	6	0,14	MB 10
KM 11	55	75	11	M 55x2	11	7	0,15	MB 11
KM 12	60	80	11	M 60x2	11	7	0,16	MB 12
KM 13	65	85	12	M 65x2	12	7	0,19	MB 13
KM 14	70	92	12	M 70x2	12	8	0,23	MB 14
KM 15	75	98	13	M 75x2	13	8	0,27	MB 15
KM 16	80	105	15	M 80x2	15	8	0,36	MB 16
KM 17	85	110	16	M 85x2	16	8	0,41	MB 17
KM 18	90	120	16	M 90x2	16	10	0,51	MB 18
KM 19	95	125	17	M 95x2	17	10	0,55	MB 19
KM 20	100	130	18	M 100x2	18	10	0,64	MB 20
KM 21	105	140	18	M 105x2	18	12	0,79	MB 21
KM 22	110	145	19	M 110x2	19	12	0,87	MB 22
KM 23	115	150	19	M 115x2	19	12	0,91	MB 23
KML 24	120	145	20	M 120x2	20	12	0,69	MBL 24
KM 24	120	155	20	M 120x2	20	12	0,97	MB 24
KM 25	125	160	21	M 125x2	21	12	1,09	MB 25
KML 26	130	155	21	M 130x2	21	12	0,8	MBL 26
KM 26	130	165	21	M 130x2	21	12	1,09	MB 26
KM 27	135	175	22	M 135x2	22	14	1,39	MB 27
KML 28	140	165	22	M 140x2	22	12	0,92	MBL 28
KM 28	140	180	22	M 140x2	22	14	1,4	MB 28
KM 29	145	190	24	M 145x2	24	14	1,8	MB 29
KML 30	150	180	24	M 150x2	24	14	1,25	MBL 30
KM 30	150	195	24	M 150x2	24	14	1,88	MB 30

Accessories

DATA TABLE - LOCKING NUT

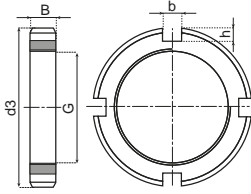

NUT	Principal dimensions				lock		Weight	Suitable for use with locking device type (not included)
	bore	outer	width	thread	width	depth		
Part number	d	d3	B	G	b	h	-	
KM 31	155	200	25	M 155x3	25	16	2,09	MB 31
KML 32	160	190	25	M 160x3	25	14	1,39	MBL 32
KM 32	160	210	25	M 160x3	25	16	2,29	MB 32
KM 33	165	210	26	M 165x3	26	16	2,31	MB 33
KML 34	170	200	26	M 170x3	26	16	1,56	MBL 34
KM 34	170	220	26	M 170x3	26	16	2,54	MB 34
KML 36	180	210	27	M 180x3	27	16	1,78	MBL 36
KM 36	180	230	27	M 180x3	27	18	2,78	MB 36
KML 38	190	220	28	M 190x3	28	16	1,84	MBL 38
KM 38	190	240	28	M 190x3	28	18	3,05	MB 38
KML 40	200	240	29	M 200x3	29	18	2,61	MBL 40
KM 40	200	250	29	M 200x3	29	18	3,37	MB 40
HM 42 T	210	270	30	Tr 210x4	20	10	4,87	MB 42
HM 44 T	220	280	32	Tr 220x4	20	10	3,35	MB 44
HM 46 T	230	290	34	Tr 230x4	20	10	5,8	MB 46
HM 48 T	240	300	34	Tr 240x4	20	10	6,2	MB 48
HM 50 T	250	320	36	Tr 250x4	20	10	7,1	MB 50
HM 52 T	260	330	36	Tr 260x4	24	12	8,4	MB 52
HM 54 T	270	340	36	Tr 270x4	24	12	9,4	MB 54
HM 56 T	280	350	38	Tr 280x4	24	12	9,6	MB 56

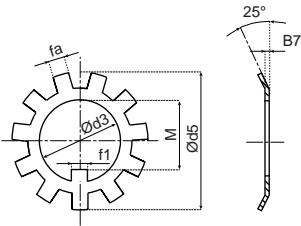

LOCKING DEVICE	Principal dimensions			Iner lip		outer lip		Weight Kg	Suitable for use with locking device type (not included)
	bore	outer	thickness	width	depth	width	number of lips		
Part number	d3	d5	B7	f1	M	fa		m	
MB 0	10	21	1	3	8,5	3	9	0,001	KM 0
MB 1	12	25	1	3	10,5	3	11	0,002	KM 1
MB 2	15	28	1	4	13,5	4	11	0,003	KM 2
MB 3	17	32	1	4	15,5	4	11	0,003	KM 3
MB 4	20	36	1	4	18,5	4	11	0,004	KM 4
MB 5	25	42	1,25	5	23	5	13	0,006	KM 5
MB 6	30	49	1,25	5	27,5	5	13	0,008	KM 6
MB 7	35	57	1,25	6	32,5	5	13	0,011	KM 7
MB 8	40	62	1,25	6	37,5	6	13	0,013	KM 8
MB 9	45	69	1,25	6	42,5	6	13	0,015	KM 9
MB 10	50	74	1,25	6	47,5	6	13	0,016	KM 10
MB 11	55	81	1,5	8	52,5	7	17	0,022	KM 11
MB 12	60	86	1,5	8	57,5	7	17	0,024	KM 12
MB 13	65	92	1,5	8	62,5	7	17	0,03	KM 13
MB 14	70	98	1,5	8	66,5	8	17	0,032	KM 14
MB 15	75	104	1,5	8	71,5	8	17	0,035	KM 15
MB 16	80	112	1,8	10	76,5	8	17	0,046	KM 16
MB 17	85	119	1,8	10	81,5	8	17	0,053	KM 17
MB 18	90	126	1,8	10	86,5	10	17	0,061	KM 18
MB 19	95	133	1,8	10	91,5	10	17	0,066	KM 19
MB 20	100	142	1,8	12	96,5	10	17	0,077	KM 20
MB 21	105	145	1,8	12	100,5	12	17	0,083	KM 21
MB 22	110	154	1,8	12	105,5	12	17	0,091	KM 22
MB 23	115	159	2	12	110,5	12	17	0,11	KM 23
MBL 24	120	151	2	14	115	12	17	0,07	KML 24
MB 24	120	164	2	14	115	12	17	0,11	KM 24
MB 25	125	170	2	14	120	12	17	0,12	KM 25
MBL 26	130	161	2	14	125	12	17	0,08	KML 26
MB 26	130	175	2	14	125	12	17	0,12	KM 26
MB 27	135	185	2	14	130	14	17	0,14	KM 27
MBL 28	140	171	2	16	135	12	17	0,09	KML 28
MB 28	140	192	2	16	135	14	17	0,14	KM 28
MB 29	145	202	2	16	140	14	17	0,17	KM 29
MBL 30	150	188	2	16	145	14	17	0,1	KML 30
MB 30	150	205	2	16	145	14	17	0,18	KM 30

Accessories

DATA TABLE - LOCKING DEVICE



LOCKING DEVICE	Principal dimensions			Inner lip		outer lip		Weight	Suitable for use with locking device type (not included)
	bore	outer	thickness	width	depth	width	number of lips		
	mm							Kg	
Part number	d3	d5	B7	f1	M	fa	m		
MB 31	155	212	2,5	16	147,5	16	19	0,2	KM 31
MBL 32	160	199	2,5	18	154	14	19	0,14	KML 32
MB 32	160	217	2,5	18	154	16	19	0,22	KM 32
MB 33	165	222	2,5	18	157,5	16	19	0,24	KM 33
MBL 34	170	211	2,5	18	164	16	19	0,15	KML 34
MB 34	170	232	2,5	18	164	16	19	0,24	KM 34
MBL 36	180	221	2,5	20	174	16	19	0,16	KML 36
MB 36	180	242	2,5	20	174	18	19	0,26	KM 36
MBL 38	190	231	2,5	20	184	16	19	0,17	KML 38
MB 38	190	252	2,5	20	184	18	19	0,26	KM 38
MBL 40	200	248	2,5	20	194	18	19	0,22	KML 40
MB 40	200	262	2,5	20	194	18	19	0,28	KM 40
MB 44	220	292	3	24	213	20	19	0,35	HM 44
MB 48	240	312	3	24	233	20	19	0,45	HM 48
MB 52	260	342	3	28	253	24	19	0,65	HM 52
MB 56	280	362	3	28	273	24	19	0,74	HM 56

TECHNICAL NOTEBOOK

ROLLWAY®

MOUNTED BALL BEARING

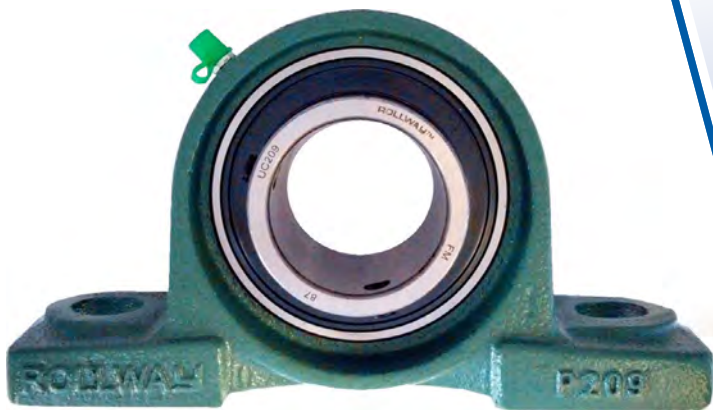

In this section:	Page
Benefits	196
Nomenclature	197
Seal Design Radial Clearance Table Insert Tolerances Table	198
Recommended Shaft Tolerances Table	199
Setscrew Maximum Tightening Torque.....	199
Data Tables	200-255

REGAL®

Mounted Ball Bearing



BENEFITS OF MOUNTED BALL BEARINGS

- Suitable for OEM and replacement applications.
- Fully interchangeable dimensions: bore diameter, shaft center height and fixing holes diameter and spacing.
- Suitable for easy mounting and dismounting.
- Absorb misalignment.
- Grease nipple standard for grease relubrication.
- Bearing insert is made from through harden 100Cr6 steel. The cage is made of steel.
- Insert meets high precision finish similar to P6. In production 100% noise inspection.
- Standard dual lip seal is made of NBR. The steel flinger is an additional barrier. A 3 lip seal is optional.
- High temperature inserts are optional: special heat-treated insert rings, high temperature grease and Viton[®]* rubber seal including flinger.
- Speed limits are similar to the 6200 2RS and 6300 2RS bearings.
- Wide inner ring and shaft locking by means of 2 set screws @ 120° or locking collar for a good stress repartitions.
- Inner rings available with tapered bores that fit into standard sleeves.
- Housings are made from cast iron. Steel and Stainless-steel housings are optional.
- Other housing design and bearing types are optional

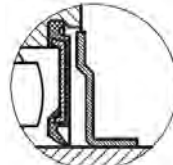

SL type Dual seal

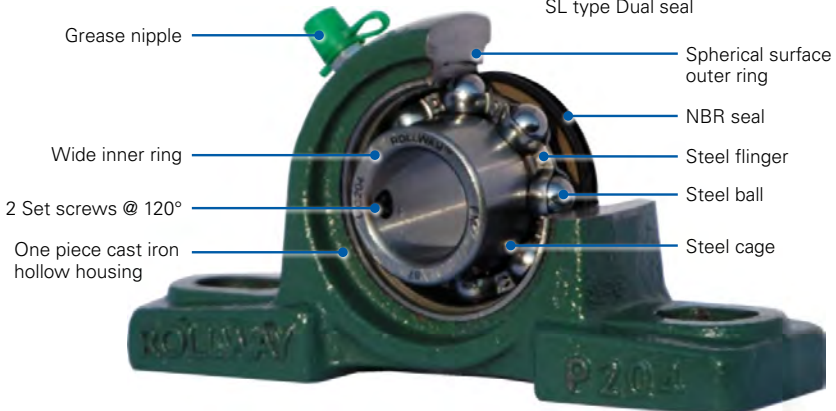

*Viton is believed to be the trademark and/or trade name of the DuPont Company and is not owned or controlled by Regal Beloit Corporation.



NOMENCLATURE

- Radial clearance is standard in CN class. Radial class C3, C4 and C5 is optional.
- Inserts are available with 3 shaft locking systems for a good stress repartitions:

2 set screw @ 120°
(standard)
UC2 / UC3 / UCX

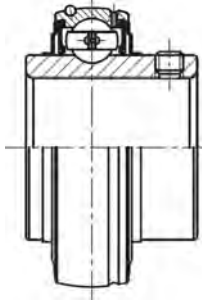

Tapered bores insert
(optional)
UK2

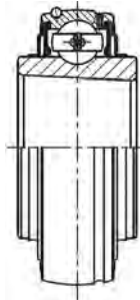

Locking collar
(optional)
HC2

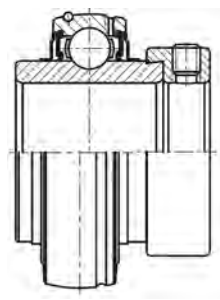

Housing type

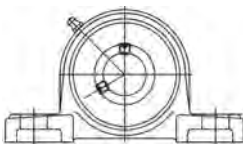

Pillow Blocks

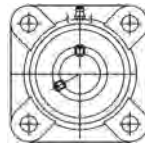

UCF

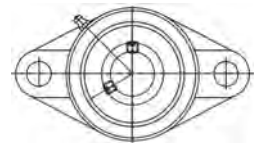

UCFL

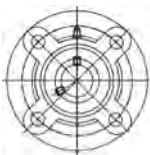

UCFC

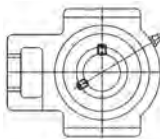

UCT

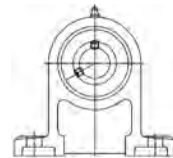

UCPH

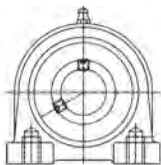

UCPA

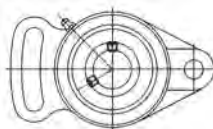

UCFA

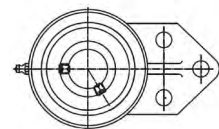

UCFB

Other types are optional

Mounted Ball Bearing



SEAL DESIGN

- Standard seal is made of a steel flinger and single lip NBR seal. 3 lip seal in option.
- Other seals designs are available.

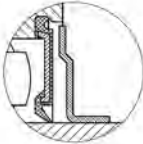

SL Type
Dual seal



L3 Type
Triple-lip seal

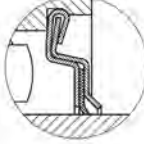

F Type
seal

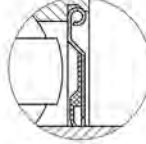

J Type
rubber seal

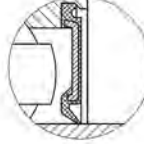

H Type
metal seal

RADIAL CLEARANCE TABLE

Bore diameter d mm		Clearance class							
		C2		CN		C4		C5	
		µm		µm		µm		µm	
over	up to	min.	max.	min.	max.	min.	max.	min.	max.
10	18	3	18	11	25	18	33	25	45
18	24	5	20	13	28	20	36	28	48
24	30	5	20	13	28	23	41	30	53
30	40	6	20	15	33	28	46	40	64
40	50	6	23	18	36	30	51	45	73
50	65	8	28	23	43	38	61	55	90
65	80	10	30	25	51	46	71	65	105
80	100	12	36	30	58	53	84	75	120
100	120	15	41	36	66	61	97	90	140
120	140	18	48	41	81	71	114	105	160

INSERT TOLERANCES TABLE

Bore diameter d mm		Cylindrical bore insert bearing					
		Ddmp		Vdp	DBs		Kia
over	incl.	min.	max.	max.	max.	min.	min.
10	18	0	+15	10	0	-120	15
18	30	0	+18	12	0	-120	18
30	50	0	+21	14	0	-120	20
50	80	0	+24	16	0	-150	25
80	120	0	+28	19	0	-200	30
120	180	0	+33	22	0	-250	35



RECOMMENDED SHAFT TOLERANCES TABLE

Bore diameter d mm		Recommended shaft tolerance							
		For high speed		Medium load		Very high speed		Heavy load	
		m6		m7		n6		n7	
over	incl.	max.	min.	max.	min.	max.	min.	max.	min.
10	18	+18	+7	+25	+7	+23	+12	+30	+12
18	30	+21	+8	+29	+8	+28	+15	+36	+15
30	50	+25	+9	+34	+9	+33	+17	+42	+17
50	80	+30	+11	+41	+11	+39	+20	+50	+20
80	120	+35	+13	+48	+13	+45	+23	+58	+23
120	180	+40	+15	+55	+15	+52	+27	+67	+27

SETSCREW MAXIMUM TIGHTENING TORQUE

Set Screw Maximum Tightening Torque				Set Screw Maximum Tightening Torque			
Metric	Nm	Inch size	lbf-inch	Metric	Nm	Inch size	lbf-inch
M5 x 0,8	3,4	10-32UNF	30	M14 x 1,5	41,2	1/2-20	287
M6 x 1,0	5,4	1/4-28	48	M16 x 1,5	62,8	9/16-18	365
M8 x 1,0	11,3	5/6-24	100	M18 x 1,5	73,4	5/8-18	556
M10 x 1,0	21,6	3/8-24	192	M20 x 1,5	117,7		
M12 x 1,5	32,4	7/16-20	210				

Mounted Ball Bearing

DATA TABLE - UCP2 / PILLOW BLOCK

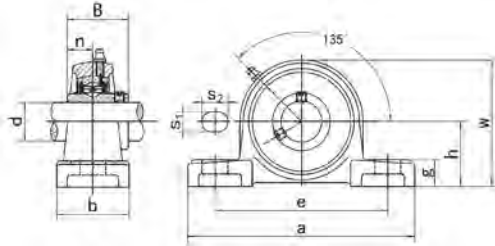

Part number	Dimensions (mm/in.)											Bolt size	Weight
	d	h	a	e	b	s ₁	s ₂	g	w	B	n	mm/in.	Kg
UCP201	12	30,2	127	95	38	13	19	14	62	31	12,7	M10	0,65
201-8	1/2	1 1/5	5	3 3/4	1 1/2	1/2	3/4	5/9	2 4/9	1.2205	0.5000	3/8	0,64
UCP202	15	30,2	127	95	38	13	19	14	62	31	12,7	M10	0,64
202-9	9/16	1 1/5	2 1/5	3 1/5	4 1/5	5 1/5	6 1/5	7 1/5	8 1/5	1.2205	0.5000	3/8	0,64
202-10	5/8												0,64
UCP203	17	30,2	127	95	38	13	19	14	62	31	12,7	M10	0,63
203-11	11/16	1 1/5	5	3 3/4	1 1/2	1/2	3/4	5/9	2 4/9	1.2205	0.5000	3/8	0,62
UCP204	20	33,3	127	95	38	13	19	14	65	31	12,7	M10	0,64
204-12	3/4	1 1/3	5	3 3/4	1 1/2	1/2	3/4	5/9	2 5/9	1.2205	0.5000	3/8	0,64
UCP205	25	36,5	140	105	38	13	19	15	71	34,1	14,3	M10	0,76
205-13	13/16	1 3/7	5 1/2	4 1/7	1 1/2	1/2	3/4	3/5	2 4/5	1.3425	0.5630	3/8	0,80
205-14	7/8												0,79
205-15	15/16												0,77
205-16	1												0,76
UCP206	30												42,9
206-17	1-1/16	1 2/3	6 2/7	4 3/4	1 3/4	2/3	4/5	2/3	3 1/3	1.5000	0.6260	1/2	1,21
206-18	1-1/8												1,22
206-19	1-3/16												1,20
206-20	1-1/4												1,19
UCP207	35												47,6
207-20	1-1/4	1 7/8	6 4/7	5	1 8/9	2/3	4/5	5/7	3 2/3	1.6890	0.6890	1/2	1,53
207-21	1-5/16												1,50
207-22	1-3/8												1,47
207-23	1-7/16												1,44
UCP208	40												49,2
208-24	1-1/2	2	7 1/4	5 2/5	2 1/8	2/3	4/5	5/7	4	1.9370	0.7480	1/2	1,90
208-25	1-9/16												1,87
UCP209	45	54	190	146	54	17	20	20	106	49,2	19	M14	2,06
209-26	1-5/8	2 1/8	7 1/2	5 3/4	2 1/8	2/3	4/5	4/5	4 1/6	1.9370	0.7480	1/2	2,16
209-27	1-11/16												2,12
209-28	1-3/4												2,08
UCP210	50												57,2
210-29	1-13/16	2 1/4	8 1/9	6 1/4	2 1/3	4/5	1	5/6	4 4/9	2.0315	0.7480	5/8	2,73
210-30	1-7/8												2,68
210-31	1-15/16												2,63
210-32	2												2,59

Mounted Ball Bearing

DATA TABLE - UCP2 / PILLOW BLOCK

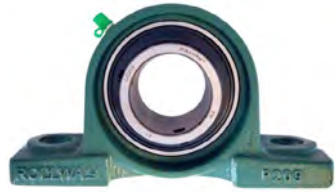

Part number	Dimensions (mm/in.)											Bolt size mm/in.	Weight Kg
	d	h	a	e	b	s ₁	s ₂	g	w	B	n		
UCP211	55	63,5	219	171	60	20	23	23	125	55,6	22,2	M16	3,23
211-32	2	2 1/2	8 5/8	6 3/4	2 1/3	4/5	1	1	5	2.1890	0.8740	5/8	3,38
211-33	2-1/16												3,32
211-34	2-1/8												3,28
211-35	2-3/16												3,21
UCP212	60	69,8	241	184	70	20	23	25	138	65,1	25,4	M16	4,40
212-36	2-1/4	2 3/4	9 1/2	7 1/4	2 3/4	4/5	1	1	5 3/7	2.5630	1.0000	5/8	4,57
212-37	2-5/16												4,49
212-38	2-3/8												4,42
212-39	2-7/16												4,35
UCP213	65	76,2	265	203	70	25	28	27	150	65,1	25,4	M20	5,35
213-40	2-1/2	3	10 3/7	8	2 3/4	1	1 1/9	1	6	2.5630	1.0000	3/4	5,44
213-41	2-9/16												5,35
UCP214	70	79,4	266	210	72	25	28	27	156	74,6	30,2	M20	5,86
214-42	2-5/8	3 1/8	10 1/2	8 1/4	2 5/6	1	1 1/9	1	6 1/7	2.937	1.189	3/4	6,07
214-43	2-11/16												5,97
214-44	2-3/4												5,87
UCP215	75												82,6
215-45	2-13/16	3 1/4	10 5/6	8 1/2	3	1	1 1/9	1 1/9	6 3/8	3.0630	1.3110	3/4	6,45
215-46	2-7/8												6,70
215-47	2-15/16												6,59
215-48	3												6,39
UCP216	80	88,9	292	232	78	25	28	30	174	82,6	33,3	M20	7,86
216-49	3-1/16	3 1/2	11 1/2	9 1/7	3	1	1 1/9	1 1/6	6 6/7	3.2520	1.3110	3/4	8,04
216-50	3-1/8												7,91
216-51	3-3/16												7,78
UCP217	85												95,2
217-52	3-1/4	3 3/4	12 1/5	9 5/7	3 1/4	1	1 1/9	1 1/4	7 2/7	3.3740	1.3425	3/4	9,68
217-53	3-5/16												9,64
217-55	3-7/16												9,35
UCP218	90												101,6
218-56	3-1/2	4	12 7/8	10 1/3	3 1/2	1	1 1/6	1 2/7	7 4/5	3,7795	1.5630	7/8	11,70

Mounted Ball Bearing

DATA TABLE - UCP3

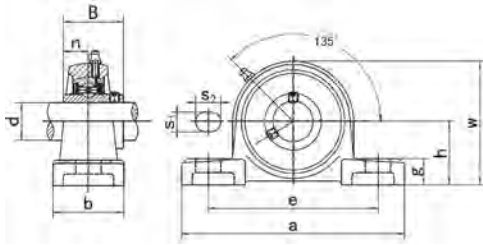

Part number	Dimensions (mm/in.)											Bolt size	Weight
	d	h	a	e	b	s ₁	s ₂	g	w	B	n	mm/in.	Kg
UCP305	25	45	175	132	45	17	20	15	85	38	15	M14	1,27
305-13	13/16	17/9	68/9	51/5	17/9	2/3	4/5	3/5	31/3	1.4961	0.5906	1/2	1,32
305-14	7/8												1,30
305-15	15/16												1,28
305-16	1												1,27
UCP306	30	50	180	140	50	17	20	18	95	43	17	M14	1,73
306-17	1-1/16	1.9685	7.0866	5.5118	1.9685	0.6693	0.7874	0.7087	3.7402	1.6929	0.6693	1/2	1,79
306-18	1-1/8												1,76
306-19	1-3/16												1,74
UCP307	35	56	210	160	56	17	25	20	106	48	19	M14	2,38
307-20	1-1/4	2.2047	8.2677	6.2992	2.2047	0.6693	0.9843	0.7874	4.1732	1.8898	0.7480	1/2	2,44
307-21	1-5/16												2,41
307-22	1-3/8												2,38
307-23	1-7/16												2,35
UCP308	40	60	220	170	60	17	27	22	116	52	19	M14	3,08
308-24	1-1/2	21/3	82/3	62/3	21/3	2/3	1	6/7	44/7	2.0472	0.7480	1/2	3,12
308-25	1-9/16												3,08
UCP309	45	67	245	190	67	20	30	24	129	57	22	M16	4,17
309-26	1-5/8	22/3	92/3	71/2	22/3	4/5	11/6	1	5	2.2441	0.8661	5/8	4,27
309-27	1-11/16												4,23
309-28	1-3/4												4,18
UCP310	50	75	275	212	75	20	35	27	143	61	22	M16	5,69
310-29	1-13/16	3	105/6	81/3	3	4/5	13/8	1	55/8	2.4016	0.8661	5/8	6,03
310-30	1-7/8												5,78
310-31	1-15/16												5,72
UCP311	55	80	310	236	80	20	38	30	154	66	25	M16	7,24
311-32	2	31/7	121/5	92/7	31/7	4/5	11/2	11/6	6	2.5984	0.9843	5/8	7,42
311-33	2-1/16												7,35
311-34	2-1/8												7,29
311-35	2-5/16												7,21
UCP312	60	85	330	250	85	25	38	32	165	71	26	M20	8,88
312-36	2-1/4	31/3	13	95/6	31/3	1	11/2	11/4	61/2	2.7953	1.0236	3/4	9,03
312-37	2-5/15												8,95
312-38	2-3/8												8,86
312-39	2-7/16												8,78
UCP313	65	90	340	260	90	25	38	33	176	75	30	M20	10,51
313-40	2-1/2	31/2	132/5	101/4	31/2	1	11/2	12/7	7	3	1.1811	3/4	10,59
313-41	2-9/16												10,49

Mounted Ball Bearing

DATA TABLE - UCP3



Part number	Dimensions (mm/in.)											Bolt size mm/in.	Weight Kg
	d	h	a	e	b	s ₁	s ₂	g	w	B	n		
UCP314	70	95	360	280	90	27	40	35	187	78	33	M22	12,04
314-42	2-3/8	33/4	141/6	11	31/2	1	14/7	13/8	71/3	3	1.2992	7/8	12,26
314-43	2-11/16												12,15
314-44	2-3/4												12,05
UCP315	75	100	380	290	100	27	40	35	198	82	32	M22	14,51
315-45	2-13/16	4	15	113/7	4	1	14/7	13/8	74/5	3.2283	1.2598	7/8	14,78
315-46	2-7/8												14,64
315-47	2-15/16												14,55
315-48	3												14,42
UCP316	80	106	400	300	110	27	40	40	210	86	34	M22	17,59
316-49	3-1/16	41/6	153/4	114/5	41/3	1	14/7	14/7	81/4	3.3858	1.3386	7/8	17,76
316-50	3-1/8												17,62
316-51	3-3/16												17,53
UCP317	85	112	420	320	110	33	45	40	220	96	40	M27	19,36
317-52	3-1/4	42/5	161/2	123/5	41/3	12/7	17/9	14/7	82/3	3.7795	1.5748	1	19,58
317-53	3-5/16												19,55
317-54	3-7/16												19,33
317-55	3-7/16												19,33
UCP318	90	118	430	330	110	33	45	45	235	96	40	M27	22,47
318-55	3-7/16	42/3	17	13	41/3	12/7	17/9	17/9	91/4	3.7795	1.5748	1	22,76
318-56	3-1/2												22,58
UCP319	95	125	470	360	120	36	50	45	250	103	41	M30	27,84
319-58	3-5/8	5	181/2	141/6	45/7	13/7	2	17/9	95/6	4.0551	1.6142	1-1/8	28,17
319-59	3-11/16												27,99
319-60	3-3/4												27,80
UCP320	100	140	490	380	120	36	50	50	275	108	42	M30	33,76
320-64	4	51/2	192/7	15	45/7	13/7	2	2	105/6	4.2520	1.6535		33,56
UCP322	110	150	520	400	140	40	55	55	300	117	46	M33	45,25
		6	201/2	153/4	51/2	14/7	21/6	21/6	114/5	4.6063	1.8110		
UCP324	120	160	570	450	140	40	55	65	320	126	51	M33	54,97
		62/7	224/9	175/7	51/2	14/7	21/6	25/9	123/5	4.9606	2.0079		
UCP326	130	180	600	480	140	40	55	75	355	135	54	M33	71,48
		7	235/8	188/9	51/2	14/7	21/6	3	14	5.3150	2.1260		
UCP328	140	200	620	500	140	40	55	75	390	145	59	M33	87,48
		77/8	242/5	192/3	51/2	14/7	21/6	3	151/3	5.7087	2.3228		

Mounted Ball Bearing

DATA TABLE - UCPX

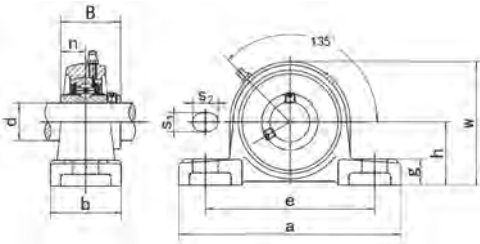

Part number	Dimensions (mm/in.)											Bolt size	Weight
	d	h	a	e	b	s ₁	s ₂	g	w	B	n	mm/in.	Kg
UCPX05	25,0	44,4	159,0	119,0	51,0	17,0	20,0	18,0	85,0	38,1	15,9	M14	1,33
305-13	13/16	1 3/4	6 1/4	4 2/3	2	2/3	4/5	5/7	3 1/3	1.5000	0.6260	1/2	
305-14	7/8												
305-15	15/16												
305-16	1												
UCPX06	30,0	47,6	175,0	127,0	57,0	17,0	20,0	20,0	93,0	42,9	17,5	M14	1,71
306-17	1-1/16	1 7/8	6 8/9	5	2 1/4	2/3	4/5	4/5	3 2/3	1.6890	0.6890	1/2	
306-18	1-1/8												
306-19	1-3/16												
UCPX07	35,0	54,0	203,0	144,0	57,0	17,0	20,0	21,0	105,0	49,2	19,0	M14	2,3
307-20	1-1/4	2 1/8	8	5 2/3	2 1/4	2/3	4/5	5/6	4 1/7	1.9370	0.7480	1/2	
307-21	1-5/16												
307-22	1-3/8												
307-23	1-7/16												
UCPX08	40,0	58,7	222,0	156,0	67,0	20,0	23,0	26,0	111,0	49,2	19,0	M16	2,84
308-24	1-1/2	2 1/3	8 3/4	6 1/7	2 2/3	4/5	1	1	4 3/8	1.9370	0.7480	5/8	
308-25	1-9/16												
UCPX09	45	58,7	222,0	156,0	67,0	20,0	23,0	26,0	116,0	51,6	19,0	M16	3,2
309-26	1-5/8	2 1/3	8 3/4	6 1/7	2 2/3	4/5	1	1	4 4/7	2.0315	0.7480	5/8	
309-27	1-11/16												
309-28	1-3/4												
UCPX10	50	63,5	241,0	171,0	73,0	20,0	23,0	27,0	126,0	55,6	22,2	M16	4,07
310-29	1-13/16	2 1/2	9 1/2	6 3/4	2 7/8	4/5	1	1	5	2.1890	0.8740	5/8	
310-30	1-7/8												
310-31	1-15/16												
UCPX11	55	69,8	260,0	184,0	79,0	25,0	28,0	30,0	137,0	65,1	25,4	M20	5,18
311-32	2	2 3/4	10 1/4	7 1/4	3 1/9	1	1 1/9	1 1/6	5 2/5	2.5630	1.0000	3/4	
311-33	2-1/16												
311-34	2-1/8												
311-35	2-5/16												
UCPX12	60	76,2	286,0	203,0	83,0	25,0	28,0	33,0	151,0	65,1	25,4	M20	6,67
312-36	2-1/4	3	11 1/4	8	3 1/4	1	1 1/9	1 2/7	6	2.5630	1.0000	3/4	
312-37	2-5/15												
312-38	2-3/8												
312-39	2-7/16												
UCPX13	65	76,2	286,0	203,0	83,0	25,0	28,0	33,0	154,0	74,6	30,2	M20	6,92
313-40	2-1/2	3	11 1/4	8	3 1/4	1	1 1/9	1 2/7	6	2.9370	1.1890	3/4	
313-41	2-9/16												

Mounted Ball Bearing

DATA TABLE - UCPX

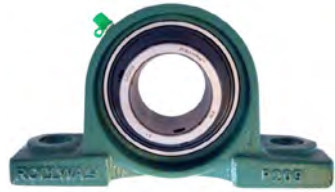

Part number	Dimensions (mm/in.)												Bolt size	Weight
	d	h	a	e	b	s ₁	s ₂	g	w	B	n	mm/in.	Kg	
UCPX14	70	88,9	330,0	229,0	89,0	27,0	30,0	35,0	170,0	778	33,3	M22	8,64	
314-42	2-3/8	3 1/2	13	9	3 1/2	1	1 1/6	1 3/8	6 2/3	3.0630	1.3110	7/8		
314-43	2-11/16													
314-44	2-3/4													
UCPX15	75	88,9	330,0	229,0	89,0	27,0	30,0	35,0	175,0	82,6	33,3	M22	9,4	
315-45	2-13/16	3 1/2	13	9	3 1/2	1	1 1/6	1 3/8	6 8/9	3.2520	1.3110	7/8		
315-46	2-7/8													
315-47	2-15/16													
315-48	3													
UCPX16	80												101,6	381,0
316-49	3-1/16	4	15	11 1/7	4	1	1 1/6	1 4/7	7 2/3	3.3740	1.3425	7/8		
316-50	3-1/8													
316-51	3-3/16													
UCPX17	85												101,6	381,0
317-52	3-1/4	4	15	11 1/7	4	1	1 1/6	1 4/7	7 7/8	3.7795	1.5630	7/8		
317-53	3-5/16													
317-55	3-7/16													
UCPX18	90												101,6	381,0
318-55	3-7/16	4	15	11 1/7	4 3/8	1	1 1/6	1 4/7	8 1/9	4.0945	1.6890	7/8		
318-56	3-1/2													
UCPX20	100												127,0	432,0
320-64	4	5	17	13 1/4	4 3/4	1 2/7	1 3/7	1 7/9	9 3/5	4.6260	1.9370	1		

Mounted Ball Bearing

DATA TABLE - UKP2

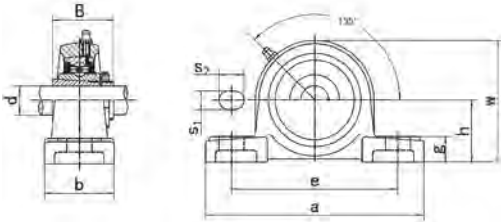

Part number	Dimensions (mm/in.)										Housing no.	Weight Kg
	d	h	a	e	b	s ₁	s ₂	g	w	B		
UKP205; H2305	20	36,5	140	105	38	13	19	15	71	35	P205	0,81
205; HE2305	3/4	1 3/7	5 1/2	4 1/7	1 1/2	1/2	3/4	3/5	2 4/5	1.3780		
UKP206; H2306	25	42,9	160	121	44	17	20	17	84	38	P206	1,26
206; HE2306	1	1 2/3	6 2/7	4 3/4	1 3/4	2/3	4/5	2/3	3 1/3	1.4961		
206; HS2306	7/8											
UKP207; H2307	30	47,6	167	127	48	17	20	18	93	43	P207	1,53
207; HS2307	1-1/8	1 7/8	6 4/7	5	1 8/9	2/3	4/5	5/7	3 2/3	1.6929		
UKP208; H2308	35	49,2	184	137	54	17	20	18	100	46	P208	1,93
208; HE2308	1-1/4	2	7 1/4	5 2/5	2 1/8	2/3	4/5	5/7	4	1.8110		
208; HS2308	1-3/8											
UKP209; H2309	40	54	190	146	54	17	20	20	106	50	P209	2,18
209; HA2309	1-7/16	2 1/8	7 1/2	5 3/4	2 1/8	2/3	4/5	4/5	4 1/6	1.9685		
209; HE2309	1-1/2											
209; HS2309	1-5/8											
UKP210; H2310	45	57,2	206	159	60	20	23	21	113	55	P210	2,78
210; HA2310	1-11/16	2 1/4	8 1/9	6 1/4	2 1/3	4/5	1	5/6	4 4/9	2.1654		
210; HE2310	1-3/4											
210; HS2310	1-5/8											
UKP211; H2311	50	63,5	219	171	60	20	23	23	125	59	P211	3,39
211; HA2311	1-15/16	2 1/2	8 5/8	6 3/4	2 1/3	4/5	1	1	5	2.3228		
211; HE2311	2											
211; HS2311	1-7/8											
UKP212; H2312	55	69,8	241	184	70	20	23	25	138	62	P212	4,52
212; HS2312	2-1/8	2 3/4	9 1/2	7 1/4	2 3/4	4/5	1	1	5 3/7	2.4409		
UKP213; H2313	60	76,2	265	203	70	25	28	27	150	65	P213	5,47
213; HA2313	2-3/16	3	10 3/7	8	2 3/4	1	1 1/9	1	6	2.5591		
213; HE2313	2-1/4											
213; HS2313	2-3/8											
UKP215; H2315	65	82,6	275	217	74	25	28	28	162	73	P215	6,84
215; HA2315	2-7/16	3 1/4	10 5/6	8 1/2	3	1	1 1/9	1 1/9	6 3/8	2.8740		
215; HE2315	2-1/2											
UKP216; H2316	70	88,9	292	232	78	25	28	30	174	78	P216	8,29
216; HA2316	2-11/16	3 1/2	11 1/2	9 1/7	3	1	1 1/9	1 1/6	6 6/7	3.0709		
216; HE2316	2-3/4											

Mounted Ball Bearing

DATA TABLE - DATA TABLE - UKP2

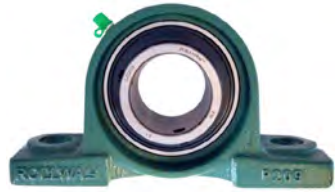

Part number	Dimensions (mm/in.)										Housing no.	Weight Kg
	d	h	a	e	b	s ₁	s ₂	g	w	B		
UKP217 ; H2317	75	95,2	310	247	83	25	28	32	185	82	P217	9,97
217 ; HA2317	2-15/16	3 3/4	12 1/5	9 5/7	3 1/4	1	1 1/9	1 1/4	7 2/7	3.2283		
217 ; HE2317	3											
UKP218 ; H2318	80	101,6	327	262	88	27	30	33	198	86	P218	11,89
218 ; HA2318	3-3/16	4	12 7/8	10 1/3	3 1/2	1	1 1/6	1 2/7	7 4/5	3.3858		

Mounted Ball Bearing

DATA TABLE - UCPH2

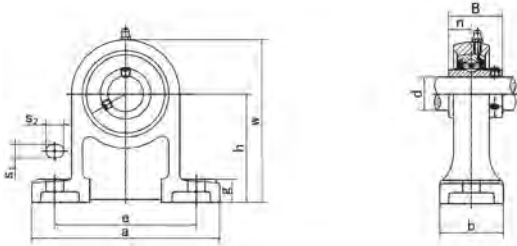

Part number	Dimensions (mm/in.)											Bolt size	Weight
	d	h	a	e	b	s ₁	s ₂	g	w	B	n	mm/in.	Kg
UCPH201	12	70	127	95	40	13	19	15	101	31	12,7	M10	0,84
201-8	1/2	2 3/4	5	3 3/4	1 4/7	1/2	3/4	3/5	4	1 2/9	1/2	3/8	0,83
UCPH202	15	70	127	95	40	13	19	15	101	31	12,7	M10	0,83
202-9	9/16	2 3/4	5	3 3/4	1 4/7	1/2	3/4	3/5	4	1 2/9	1/2	3/8	0,83
202-10	5/8												0,83
UCPH203	17	70	127	95	40	13	19	15	101	31	12,7	M10	0,82
203-11	11/16	2 3/4	5	3 3/4	1 4/7	1/2	3/4	3/5	4	1 2/9	1/2	3/8	0,81
UCPH204	20	70	127	95	40	13	19	15	101	31	12,7	M10	0,80
204-12	3/4	2 3/4	5	3 3/4	1 4/7	1/2	3/4	3/5	4	1 2/9	1/2	3/8	0,80
UCPH205	25	80	140	105	50	13	19	16	114	34,1	14,3	M10	1,04
205-13	13/16	3 1/7	5 1/2	4 1/7	2	1/2	3/4	5/8	4 1/2	1 1/3	4/7	3/8	1,08
205-14	7/8												1,07
205-15	15/16												1,05
205-16	1												1,04
UCPH206	30												90
206-17	1-1/16	3 1/2	6 1/3	4 3/4	2	2/3	5/6	2/3	5 1/8	1 1/2	5/8	1/2	1,46
206-18	1-1/8												1,47
206-19	1-3/16												1,45
206-20	1-1/4												1,44
UCPH207	35												95
207-20	1-1/4	3 3/4	6 1/2	5	2 1/3	2/3	5/6	18	5 1/2	1 2/3	2/3	1/2	1,89
207-21	1-5/16												1,86
207-22	1-3/8												1,83
207-23	1-7/16												1,80
UCPH208	40												100
208-24	1-1/2	4	7	5 2/5	2 3/4	2/3	5/6	19	6	2	3/4	1/2	2,44
208-25	1-9/16												2,41
UCPH209	45	105	189	146	70	17	21	20	158	49,2	19	M14	2,67
209-26	1-5/8	4 1/7	7 4/9	5 3/4	2 3/4	2/3	5/6	20	6 2/9	2	3/4	1/2	2,77
209-27	1-11/16												2,37
209-28	1-3/4												2,69
UCPH210	50												110
210-29	1-13/16	4 1/3	8	6 1/4	2 3/4	4/5	1	21	6 1/2	2	3/4	5/8	3,09
210-30	1-7/8												3,04
210-31	1-15/16												2,99
210-32	2												2,95

Mounted Ball Bearing

DATA TABLE - UCPH2



Part number	Dimensions (mm/in.)											Bolt size	Weight
	d	h	a	e	b	s ₁	s ₂	g	w	B	n	mm/in.	Kg
UCPH211	55	120	219	171	75	20	23	23	181	55,6	22,2	M16	3,82
211-32	2	4 5/7	8 5/8	6 3/4	3	4/5	1	22	7 1/8	2 1/5	7/8	5/8	3,97
211-33	2-1/16												3,87
211-34	2-1/8												3,91
211-35	2-3/16												3,80
UCPH212	60	130	241	184	85	20	23	25	197	65,1	25,4	M16	5,01
212-36	2-1/4	5 1/8	9 1/2	7 1/4	3 1/3	4/5	1	25	7 3/4	2 4/7	1	5/8	5,14
212-37	2-5/16												5,06
212-38	2-3/8												4,99
212-39	2-7/16												4,92
UCPH213	65	140	265	203	95	25	28	27	212	65,1	25,4	M20	6,11
213-40	2-1/2	5 1/2	10 3/7	8	3 3/4	1	1 1/9	27	8 1/3	2 4/7	1	3/4	6,20
213-41	2-9/16												6,11
UCPH214	70	150	266	210	105	25	28	27	225	74,6	30,2	M20	7,06
214-42	2-5/8	6	10 1/2	8 1/4	4 1/7	1	1 1/9	28	8 6/7	3	1 1/5	3/4	7,27
214-43	2-11/16												7,17
214-44	2-3/4												7,07
UCPH215	75												160
215-45	2-13/16	6 2/7	10 5/6	8 1/2	4 1/2	1	1 1/9	29	9 3/8	3	1 1/3	3/4	7,98
215-46	2-7/8												8,23
215-47	2-15/16												8,12
215-48	3												7,92
UCPH216	80	170	292	232	125	25	28	30	253	82,6	33,3	M20	9,30
216-49	3-1/16	6 2/3	11 1/2	9 1/7	5	1	1 1/9	30	10	3 1/4	1 1/3	3/4	9,48
216-50	3-1/8												9,35
216-51	3-3/16												9,22

Mounted Ball Bearing

DATA TABLE - UCPA2

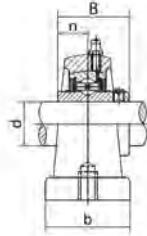
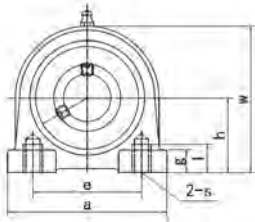

Part number	Dimensions (mm/in.)											Bolt size	Weight
	d	h	a	e	b	s	g	l	w	B	n	mm/in.	Kg
UCPA201	12	30,2	76	52	40	M10	11	15	62	31	12,7	M10	0,63
201-8	1/2	1 1/5	3	2	1 4/7	3/8	3/7	3/5	2 4/9	1 2/9	1/2	3/8	0,62
UCPA202	15	1 1/5	3	2	1 4/7	3/8	3/7	3/5	2 4/9	1 2/9	1/2	3/8	0,62
202-9	9/16												0,62
202-10	5/8												0,62
UCPA203	17	1 1/5	3	2	1 4/7	3/8	3/7	3/5	2 4/9	1 2/9	1/2	3/8	0,61
203-11	11/16												0,60
UCPA204	20	1 1/5	3	2	1 4/7	3/8	3/7	3/5	2 4/9	1 2/9	1/2	3/8	0,59
204-12	3/4												0,59
UCPA205	25	36,5	84	56	38	M10	12	15	72	34,1	14,3	M10	0,76
205-13	13/16	1 3/7	3 1/3	2 1/5	1 1/2	3/8	1/2	3/5	2 5/6	1 1/3	4/7	3/8	0,79
205-14	7/8												0,78
205-15	15/16												0,76
205-16	1												0,75
UCPA206	30												42,9
206-17	1-1/16	1 2/3	3 5/7	2 3/5	2	1/2	1/2	5/7	3 1/3	1 1/2	5/8	1/2	1,13
206-18	1-1/8												1,14
206-19	1-3/16												1,12
206-20	1-1/4												1,11
UCPA207	35												47,6
207-20	1-1/4	1 7/8	4 1/3	3 1/7	2 1/6	1/2	1/2	18	3 3/4	1 2/3	2/3	1/2	1,61
207-21	1-5/16												1,58
207-22	1-3/8												1,55
207-23	1-7/16												1,52
UCPA208	40												49,2
208-24	1-1/2	2	4 4/7	3 1/3	2 2/7	1/2	1/2	19	4	2	3/4	1/2	1,84
208-25	1-9/16												1,81
UCPA209	45	54,2	120	90	60	M14	13	25	108	49,2	19	M14	2,05
209-26	1-5/8	2 1/7	4 5/7	3 1/2	2 1/3	1/2	1/2	20	4 1/4	2	3/4	1/2	2,15
209-27	1-11/16												2,11
209-28	1-3/4												2,07
UCPA210	50												57,2
210-29	1-13/16	2 1/4	5 1/8	3 5/7	2 1/2	5/8	5/9	21	4 4/7	2	3/4	5/8	2,68
210-30	1-7/8												2,63
210-31	1-15/16												2,58
210-32	2												2,54



Part number	Dimensions (mm/in.)												Bolt size	Weight
	d	h	a	e	b	s	g	l	w	B	n	mm/in.	Kg	
UCPA211	55	63,5	140	104	66	M16	14	25	125	55,6	22,2	M16	3,14	
211-32	2	2 1/2	5 1/2	4	2 3/5	5/8	5/9	22	5	2 1/5	7/8	5/8	3,29	
211-33	2-1/16												3,23	
211-34	2-1/8												3,19	
211-35	2-3/16												3,12	
UCPA212	60	69,9	150	114	68	M16	15	25	138	65,1	25,4	M16	4,12	
212-36	2-1/4	2 3/4	6	4 1/2	2 2/3	5/8	3/5	25	5 3/7	2 4/7	1	5/8	4,25	
212-37	2-5/16												4,17	
212-38	2-3/8												4,10	
212-39	2-7/16												4,03	
UCPA213	65	76,2	160	124	70	M16	15	25	150	65,1	25,4	M16	4,92	
213-40	2-1/2	3	6 2/7	4 7/8	2 3/4	5/8	3/5	27	6	2 4/7	1	5/8	5,01	
213-41	2-9/16												4,92	

Mounted Ball Bearing

DATA TABLE - UCF2

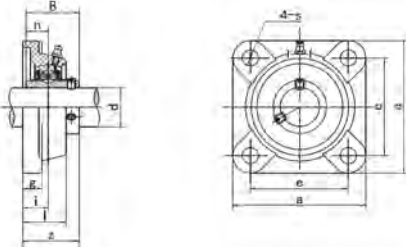

Part number	Dimensions (mm/in.)											Bolt size	Weight
	d	a	e	i	g	l	s	z	t	B	n	mm/in.	Kg
UCF201	12	86	64	15	12	25,5	12	33,3	37,5	31	12,7	M10	0,59
201-8	1/2	3 2/5	2 1/2	3/5	1/2	1	1/2	1 1/3	1 1/2	1.2205	0.5000	3/8	0,58
UCF202	15	86	64	15	12	25,5	12	33,3	37,5	31	12,7	M10	0,58
202-9	9/16	3 2/5	2 1/2	3/5	1/2	1	1/2	1 1/3	1 1/2	1.2205	0.5000	3/8	0,58
202-10	5/8												0,58
UCF203	17	86	64	15	12	25,5	12	33,3	37,5	31	12,7	M10	0,57
203-11	11/16	3 2/5	2 1/2	3/5	1/2	1	1/2	1 1/3	1 1/2	1.2205	0.5000	3/8	0,56
UCF204	20	86	64	15	12	25,5	12	33,3	37,5	31	12,7	M10	0,55
204-12	3/4	3 2/5	2 1/2	3/5	1/2	1	1/2	1 1/3	1 1/2	1.2205	0.5000	3/8	0,55
UCF205	25	95	70	16	14	27	12	35,8	40	34,1	14,3	M10	0,73
205-13	13/16	3 3/4	2 3/4	5/8	5/9	1	1/2	1 2/5	1 4/7	1.3425	0.5630	3/8	0,77
205-14	7/8												0,76
205-15	15/16												0,74
205-16	1												0,73
UCF206	30	108	83	18	14	31	12	40,2	44,5	38,1	15,9	M10	1,02
206-17	1-1/16	4 1/4	3 1/4	5/7	5/9	1 2/9	1/2	1 4/7	1 3/4	1.5000	0.6260	3/8	1,03
206-18	1-1/8												1,04
206-19	1-3/16												1,02
206-20	1-1/4												1,01
UCF207	35	117	92	19	16	34	14	44,4	48,5	42,9	17,5	M12	1,33
207-20	1-1/4	4 3/5	3 5/8	3/4	5/8	1 1/3	5/9	1 3/4	2	1.6890	0.6890	7/16	1,40
207-21	1-5/16												1,37
207-22	1-3/8												1,34
207-23	1-7/16												1,31
UCF208	40	130	102	21	16	36	16	51,2	55,5	49,2	19	M14	1,67
208-24	1-1/2	5 1/8	4	5/6	5/8	1 3/7	5/8	2	2 1/5	1.9370	0.7480	1/2	1,71
208-25	1-9/16												1,68
UCF209	45	137	105	22	18	38	16	52,2	56,5	49,2	19	M14	2,00
209-26	1-5/8	5 2/5	4 1/7	6/7	5/7	1 1/2	5/8	2	2 2/9	1.9370	0.7480	1/2	2,10
209-27	1-11/16												2,06
209-28	1-3/4												2,02
UCF210	50	143	111	22	18	40	16	54,6	59,5	51,6	19	M14	2,32
210-29	1-13/16	5 5/8	4 3/8	6/7	5/7	1 4/7	5/8	2 1/7	2 1/3	2.0315	0.7480	1/2	2,44
210-30	1-7/8												2,39
210-31	1-15/16												2,34
210-32	2												2,30

Mounted Ball Bearing

DATA TABLE - UCF2



Part number	Dimensions (mm/in.)											Bolt size	Weight
	d	a	e	i	g	l	s	z	t	B	n	mm/in.	Kg
UCF211	55	162	130	25	20	43	19	58,4	63	55,6	22,2	M16	3,12
211-32	2	6 3/8	5 1/8	1	4/5	1 2/3	3/4	2 2/7	2 1/2	2.1890	0.8740	5/8	3,27
211-33	2-1/16												3,21
211-34	2-1/8												3,17
211-35	2-3/16												3,10
UCF212	60	175	143	29	20	48	19	68,7	73,5	65,1	25,4	M16	3,95
212-36	2-1/4	6 8/9	5 5/8	1 1/7	4/5	1 8/9	3/4	2 5/7	2 8/9	2.5630	1.0000	5/8	4,08
212-37	2-5/16												4,00
212-38	2-3/8												3,93
212-39	2-7/16												3,86
UCF213	65	187	149	30	22	50	19	69,7	74,5	65,1	25,4	M16	4,81
213-40	2-1/2	7 1/3	5 6/7	1 1/6	6/7	2	3/4	2 3/4	3	2.5630	1.0000	5/8	4,90
213-41	2-9/16												4,81
UCF214	70	193	152	31	22	54	19	75,4	81,5	74,6	30,2	M16	5,42
214-42	2-5/8	7 3/5	6	1 2/9	6/7	2 1/8	3/4	3	3 1/5	2.9370	1.1890	5/8	5,63
214-43	2-11/16												5,53
214-44	2-3/4												5,43
UCF215	75												200
215-45	2-13/16	7 7/8	6 1/4	1 1/3	6/7	2 1/5	3/4	3	3 2/7	3.0630	1.3110	5/8	5,94
215-46	2-7/8												6,19
215-47	2-15/16												6,08
215-48	3												5,88
UCF216	80	208	165	34	22	58	23	83,3	88,5	82,6	33,3	M20	6,94
216-49	3-1/16	8 1/5	6 1/2	1 1/3	6/7	2 2/7	1	3 2/7	3 1/2	3.2520	1.3110	3/4	7,12
216-50	3-1/8												6,99
216-51	3-3/16												6,86
UCF217	85												220
217-52	3-1/4	8 2/3	6 8/9	1 3/7	1	2 1/2	1	3 4/9	3 2/3	3.374	1.3425	3/4	8,79
217-53	3-5/16												8,75
217-55	3-7/16												8,46
UCF218	90												235
218-56	3-1/2	9 1/4	7 1/3	1 4/7	1	2 2/3	1	3 4/5	4	3.7795	1.5630	3/4	10,73

Mounted Ball Bearing

DATA TABLE - UCF3

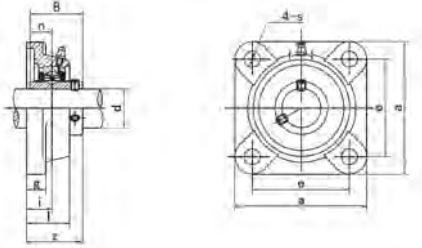

Part number	Dimensions (mm/in.)											Bolt size mm/in.	Weight Kg
	d	a	e	i	g	l	s	z	B	n			
UCF305	25	110	80	16	13	29	16	39	38	15	M14	1,10	
305-13	13/16	4 1/3	3 1/7	5/8	1/2	1 1/7	5/8	1 1/2	1.4961	0.5906	1/2		
305-14	7/8												
305-15	15/16												
305-16	1												
UCF306	30											125	95
306-17	1-1/16	5	3 3/4	5/7	3/5	1 1/4	5/8	1 3/4	1.6929	0.6693	1/2		
306-18	1-1/8												
306-19	1-3/16												
UCF307	35											135	100
307-20	1-1/4	5 1/3	4	4/5	5/8	1 3/7	3/4	2	1.8898	0.748	5/8		
307-21	1-5/16												
307-22	1-3/8												
307-23	1-7/16												
UCF308	40											150	112
308-24	1-1/2	6	4 2/5	1	2/3	1 4/7	3/4	2 1/5	2.0472	0.748	5/8		
308-25	1-9/16												
UCF309	45											160	125
309-26	1-5/8	6 2/7	5	1	5/7	1 3/4	3/4	2 1/3	2.2441	0.8661	5/8		
309-27	1-11/16												
309-28	1-3/4												
UCF310	50											175	132
310-29	1-13/16	6 8/9	5 1/5	1 1/9	3/4	1 8/9	1	2 2/3	2.4016	0.8661	3/4		
310-30	1-7/8												
310-31	1-15/16												
UCF311	55											185	140
311-32	2	7 2/7	5 1/2	1 1/6	4/5	2	1	2 4/5	2.5984	0.9843	3/4		
311-33	2-1/16												
311-34	2-1/8												
311-35	2-5/16												
UCF312	60											195	150
312-36	2-1/4	7 2/3	6	1 2/7	6/7	2 1/5	1	3	2.7953	1.0236	3/4		
312-37	2-5/15												
312-38	2-3/8												
312-39	2-7/16												

Mounted Ball Bearing

DATA TABLE - UCF3



Part number	Dimensions (mm/in.)										Bolt size	Weight
	d	a	e	i	g	l	s	z	B	n	mm/in.	Kg
UCF313	65	208	166	33	22	58	23	78	75	30	M20	7,90
313-40	2-1/2	8 1/5	6 1/2	1 2/7	6/7	2 2/7	1	3	2.9528	1.1811	3/4	
313-41	2-9/16											
UCF314	70	226	178	36	25	61	25	81	78	33	M22	9,60
314-42	2-3/8	8 8/9	7	1 3/7	1	2 2/5	1	3 1/5	3.0709	1.2992	7/8	
314-43	2-11/16											
314-44	2-3/4											
UCF315	75	236	184	39	25	66	25	89	62	32	M22	11,00
315-45	2-13/16	9 2/7	7 1/4	1 1/2	1	2 3/5	1	3 1/2	2.4409	1.2598	7/8	
315-46	2-7/8											
315-47	2-15/16											
315-48	3											
UCF316	80											250
316-49	3-1/16	9 5/6	7 5/7	1 1/2	1	2 2/3	1 2/9	3 1/2	3.3858	1.3386	1	
316-50	3-1/8											
316-51	3-3/16											
UCF317	85											260
317-52	3-1/4	10 1/4	8	1 3/4	1	3	1 2/9	4	3.7795	1.5748	1	
317-53	3-5/16											
317-55	3-7/16											
UCF318	90											280
318-55	3-7/16	11	8 1/2	1 3/4	1 1/6	3	1 3/8	4	3.7795	1.5748	1-1/8	
318-56	3-1/2											
UCF319	95	290	228	59	30	94	35	121	103	41	M30	22,80
319-58	3-5/8	11 3/7	9	2 1/3	1 1/6	3 5/7	1 3/8	4 3/4	4.0551	1.6142	1-1/8	
319-59	3-11/16											
319-60	3-3/4											
UCF320	100											310
320-64	4	12 1/5	9 1/2	2 1/3	1 1/4	3 5/7	1 1/2	5	4.252	1.6535	1-1/4	
UCF322	110	340	266	60	35	96	41	131	117	46	M36	34,90
		13 2/5	10 1/2	2 1/3	1 3/8	3 7/9	1 3/5	5 1/6	4.6063	1.811		
UCF324	120	370	290	65	40	110	41	140	126	51	M36	46,80
		14 4/7	11 3/7	2 5/9	1 4/7	4 1/3	1 3/5	5 1/2	4.9606	2.0079		
UCF326	130	410	320	65	45	115	41	146	135	54	M36	62,60
		16 1/7	12 3/5	2 5/9	1 7/9	4 1/2	1 3/5	5 3/4	5.315	2.126		
UCF328	140	450	350	75	55	125	41	161	145	59	M36	85,50
		17 5/7	13 7/9	3	2 1/6	5	1 3/5	6 1/3	5.7087	2.3228		

Mounted Ball Bearing

DATA TABLE - UCFX

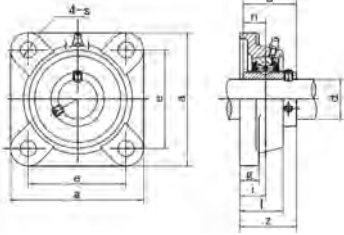

Part number	Dimensions (mm/in.)											Bolt size mm/in.	Weight Kg
	d	a	e	i	g	l	s	z	B	n			
UCF305	25	108	83	18	13	30	12	40,2	38,1	15,9	M10	1,10	
305-13	13/16	4 1/4	3 1/4	5/7	1/2	1 1/6	1/2	1 4/7	1.5000	0.6260	3/8		
305-14	7/8												
305-15	15/16												
305-16	1												
UCF306	30											117	92
306-17	1-1/16	4 3/5	3 5/8	3/4	5/9	1 1/3	5/8	1 3/4	1.6890	0.6890	1/2		
306-18	1-1/8												
306-19	1-3/16												
UCF307	35											130	102
307-20	1-1/4	5 1/8	4	5/6	5/9	1 1/2	5/8	2	1.9370	0.7480	1/2		
307-21	1-5/16												
307-22	1-3/8												
307-23	1-7/16												
UCF308	40											137	105
308-24	1-1/2	5 2/5	4 1/7	6/7	5/9	1 4/7	3/4	2	1.9370	0.7480	5/8		
308-25	1-9/16												
UCF309	45											143	111
309-26	1-5/8	5 5/8	4 3/8	1	5/9	1 4/7	3/4	2 1/5	2.0315	0.7480	5/8		
309-27	1-11/16												
309-28	1-3/4												
UCF310	50											162	130
310-29	1-13/16	6 3/8	5 1/8	1	4/5	1 3/4	3/4	2 1/3	2.1890	0.8740	5/8		
310-30	1-7/8												
310-31	1-15/16												
UCF311	55											175	143
311-32	2	6 8/9	5 5/8	1 1/7	4/5	2	3/4	2 5/7	2.5630	1.0000	5/8		
311-33	2-1/16												
311-34	2-1/8												
311-35	2-5/16												
UCF312	60											187	149
312-36	2-1/4	7 1/3	5 6/7	1 1/3	5/6	2 1/3	3/4	3	2.5630	1.0000	5/8		
312-37	2-5/15												
312-38	2-3/8												
312-39	2-7/16												

Mounted Ball Bearing

DATA TABLE - UCFX



Part number	Dimensions (mm/in.)										Bolt size	Weight
	d	a	e	i	g	l	s	z	B	n	mm/in.	Kg
UCF313	65	187	149	34	21	59	19	78	75	30,2	M16	5,40
313-40	2-1/2	7 1/3	5 6/7	1 1/3	5/6	2 1/3	3/4	3	2.9370	1.1890	5/8	
313-41	2-9/16											
UCF314	70	197	152	37	24	60	23	82	78	33,3	M20	6,30
314-42	2-3/8	7 3/4	6	1 1/2	1	2 1/3	1	3 1/5	3.0630	1.3110	3/4	
314-43	2-11/16											
314-44	2-3/4											
UCF315	75	197	152	40	24	68	23	89	83	33,3	M20	7,60
315-45	2-13/16	7 3/4	6	1 4/7	1	2 2/3	1	3 1/2	3.2520	1.3110	3/4	
315-46	2-7/8											
315-47	2-15/16											
315-48	3											
UCF316	80	214	171	40	24	70	23	92	86	34,1	M20	9,40
316-49	3-1/16	8 3/7	6 3/4	1 4/7	1	2 3/4	1	3 3/5	3.3740	1.3425	3/4	
316-50	3-1/8											
316-51	3-3/16											
UCF317	85	214	171	40	24	70	23	96	96	39,7	M20	10,40
317-52	3-1/4	8 3/7	6 3/4	1 4/7	1	2 3/4	1	3 4/5	3.7795	1.5630	3/4	
317-53	3-5/16											
317-55	3-7/16											
UCF318	90	214	171	45	24	76	23	106	104	42,9	M20	11,70
318-55	3-7/16	8 3/7	6 3/4	1 7/9	1	3	1	4 1/6	4.0945	1.6890	3/4	
318-56	3-1/2											
UCF320	100	268	211	59	31	97	31	127	118	49,2	M27	20,20
320-64	4	10 5/9	8 1/3	2 1/3	1 2/9	3 5/6	1 2/9	5	4.6260	1.9370	1	

Mounted Ball Bearing

DATA TABLE - UKF2+H

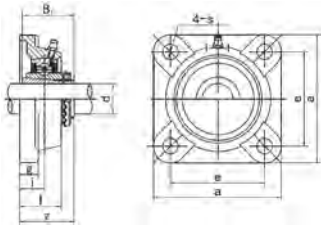

Part number	Dimensions (mm/in.)										Bolt Size no.	Weight Kg
	d	a	e	i	g	l	s	z	B ₁			
UKF205; H2305	20	95	70	16	14	27	12	35,5	35	M10	0,78	
205; HE2305	3/4	3-3/4	2-3/4	5/8	35/64	1-1/16	15/32	1-25/64	1.378	3/8		
UKF206; H2306	25	108	83	18	14	31	12	39	38	M10	1,09	
206; HE2306	1	4-1/4	3-17/64	45/64	35/64	1-7/32	15/32	1-17/32	1.496	3/8		
206; HS2306	7/8											
UKF207; H2307	30	117	92	19	16	34	14	42,5	43	M12	1,41	
207; HS2307	1-1/8	4-39/64	3-5/8	3/4	5/8	1-11/32	35/64	1-43/64	1.693	7/16		
UKF208; H2308	35	130	102	21	16	36	16	46,5	46	M14	1,74	
208; HE2308	1-1/4	5-1/8	4-1/64	53/64	5/8	1-27/64	5/8	1-53/64	1.811	1/2		
208; HS2308	1-3/8											
UKF209; H2309	40	137	105	22	18	38	16	48,5	50	M14	2,12	
209; A2309	1-7/16	5-13/32	4-9/64	55/64	23/32	1-1/2	5/8	1-29/32	1.969	1/2		
209; HE2309	1-1/2											
209; HS2309	1-5/8											
UKF210; H2310	45	143	111	22	18	40	16	50	55	M14	2,49	
210; HA2310	1-11/16	5-5/8	4-3/8	55/64	23/32	1-9/16	5/8	1-31/32	2.165	1/2		
210; HE2310	1-3/4											
210; HS2310	1-5/8											
UKF211; H2311	50	162	130	25	20	43	19	54,5	59	M16	3,28	
211; HA2311	1-15/16	6-3/8	5-1/8	63/64	25/32	1-11/16	3/4	2-9/64	2.323	5/8		
211; HE2311	2											
211; HS2311	1-7/8											
UKF212; H2312	55	175	143	29	20	48	19	61	62	M16	4,03	
212; HS2312	2-1/8	6-57/64	5-5/8	1-9/64	25/32	1-57/64	3/4	2-13/32	2.441	5/8		
UKF213; H2313	60	187	149	30	22	50	19	64	65	M16	4,93	
213; HA2313	2-3/16	7-23/64	5-55/64	1-3/16	55/64	1-31/32	3/4	2-33/64	2.559	5/8		
213; HE2313	2-1/4											
213; HS2313	2-3/8											
UKF215; H2315	65	200	159	34	22	56	19	71	73	M16	6,33	
215; HA2315	2-7/16	7-7/8	6-17/64	1-11/32	55/64	2-7/32	3/4	2-51/64	2.874	5/8		
215; HE2315	2-1/2											
UKF216; H2316	70	208	165	34	22	58	23	73,5	78	M20	7,37	
216; HA2316	2-11/16	8-3/16	6-1/2	1-11/32	55/64	2-9/32	29/32	2-57/64	3.071	3/4		
216; HE2316	2-3/4											

Mounted Ball Bearing

DATA TABLE - UKF2+H



Part number	Dimensions (mm/in.)										Bolt Size no.	Weight Kg
	d	a	e	i	g	l	s	z	B ₁			
UKF217; H2317	75	220	175	36	24	63	23	77	82	M20	9,09	
217; HA2317	2-15/16	8-21/32	6-57/64	1-27/64	15/16	2-15/32	29/32	3-1/32	3.228	3/4		
217; HE2317	3											
UKF218; H2318	80	235	187	40	24	68	23	81,5	86	M20	10,91	
218; HA2318	3-3/16	9-1/4	7-23/64	1-37/64	15/16	2-11/16	29/32	3-13/64	3.386	3/4		

Mounted Ball Bearing

DATA TABLE - UCFA2

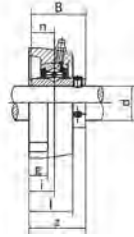
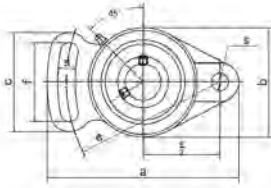

Part number	Dimensions (mm/in.)													Bolt size	Weight
	d	a	e	i	g	l	s	b	z	f	c	B	n	mm/in.	Kg
UCFA201	12	98	78	15	12	25,5	10	15	33,3	40	50	31	12,7	M10	0,46
201-8	1/2	3 6/7	3	3/5	1/2	1	2/5	3/5	1 1/3	1 4/7	2	1 2/9	1/2	3/8	0,45
UCFA202	15														0,45
202-9	9/16	3 6/7	3	3/5	1/2	1	2/5	3/5	1 1/3	1 4/7	2	1 2/9	1/2	3/8	0,45
202-10	5/8														0,45
UCFA203	17														0,44
203-11	11/16	3 6/7	3	3/5	1/2	1	2/5	3/5	1 1/3	1 4/7	2	1 2/9	1/2	3/8	0,43
UCFA204	20														0,42
204-12	3/4	3 6/7	3	3/5	1/2	1	2/5	3/5	1 1/3	1 4/7	2	1 2/9	1/2	3/8	0,42
UCFA205	25	124	98	16	14	27	13	15	35,8	51	65	34,1	14,3	M10	0,65
205-13	13/16														0,68
205-14	7/8	4 7/8	3 6/7	5/8	5/9	1	1/2	3/5	1 2/5	2	2 5/9	1 1/3	4/7	3/8	0,67
205-15	15/16														0,65
205-16	1														0,64
UCFA206	30	141	115	18	14	31	13	18	40,2	58	72	38,1	15,9	M14	0,95
206-17	1-1/16														0,98
206-18	1-1/8	5 5/9	4 1/2	5/7	5/9	1 2/9	1/2	5/7	1 4/7	2 2/7	2 5/6	1 1/2	5/8	1/2	0,97
206-19	1-3/16														0,95
206-20	1-1/4														0,94
UCFA207	35	155	128	19	16	34	15	20	44,4	66	82	42,9	17,5	M14	1,33
207-20	1-1/4														1,40
207-21	1-5/16	6 1/9	5	3/4	5/8	1 1/3	3/5	18	1 3/4	2 3/5	3 2/9	1 2/3	2/3	1/2	1,37
207-22	1-3/8														1,34
207-23	1-7/16														1,31
UCFA208	40	171	142	21	16	38	15	20	51,2	71	87	49,2	19	M14	1,73
208-24	1-1/2	6 3/4	5 3/5	5/6	5/8	1 1/2	3/5	19	2	2 4/5	3 3/7	2	3/4	1/2	1,77
208-25	1-9/16														1,74
UCFA209	45	179	146	22	18	40	17	25	52,2	72	90	49,2	19	M14	1,98
209-26	1-5/8														2,08
209-27	1-11/16	7	5 3/4	6/7	5/7	1 4/7	2/3	20	2	2 5/6	3 1/2	2	3/4	1/2	2,04
209-28	1-3/4														2,00
UCFA210	50	189	155	22	18	40	17	25	54,6	76	94	51,6	19	M16	2,12
210-29	1-13/16														2,24
210-30	1-7/8	7 4/9	6 1/9	6/7	5/7	1 4/7	2/3	21	2 1/7	3	3 5/7	2	3/4	5/8	2,19
210-31	1-15/16														2,14
210-32	2														2,10

Mounted Ball Bearing

DATA TABLE - UCFA2



Part number	Dimensions (mm/in.)														Bolt size	Weight
	d	a	e	i	g	l	s	b	z	f	c	B	n	mm/in.	Kg	
UCFA211	55	216	182	25	20	44	17	25	58,4	86	104	55,6	22,2	M16	3,11	
211-32	2	8 1/2	7 1/6	1	4/5	1 3/4	2/3	22	2 2/7	3 2/5	4	2 1/5	7/8	5/8	3,26	
211-33	2-1/16														3,20	
211-34	2-1/8														3,16	
211-35	2-3/16														3,09	
UCFA212	60	240	202	29	20	448	19	25	68,7	100	118	65,1	25,4	M16	3,76	
212-36	2-1/4	9 4/9	8	1 1/7	4/5	17 2/3	3/4	25	2 5/7	4	4 2/3	2 4/7	1	5/8	3,89	
212-37	2-5/16														3,81	
212-38	2-3/8														3,74	
212-39	2-7/16														3,67	
UCFA213	65	250	210	30	20	50	19	25	69,7	102	122	65,1	25,4	M16	4,70	
213-40	2-1/2	9 5/6	8 1/4	1 1/6	4/5	2	3/4	27	2 3/4	4	4 4/5	2 4/7	1	5/8	4,79	
213-41	2-9/16														4,70	

Mounted Ball Bearing

DATA TABLE - UCFB2

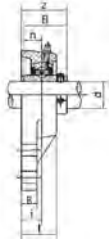
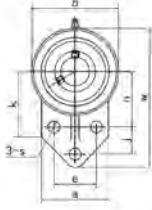

Part number	Dimensions (mm/in.)															Bolt size	Weight
	d	w	b	k	a	l	s	g	h	j	e	z	B	n	mm/in.	Kg	
UCFB201	12	110	62	52	52	25,5	10	13	42	27	32	33,3	31,0	12,7	M8	0,59	
201-8	1/2	116	2 4/9	2	2	1	2/5	1/2	1 2/3	1	34	1 1/3	1 2/9	1/2	5/16	0,58	
UCFB202	15															0,58	
202-9	9/16	116	2 4/9	2	2	1	2/5	1/2	1 2/3	1	34	1 1/3	1 2/9	1/2	5/16	0,58	
202-10	5/8															0,58	
UCFB203	17															0,57	
203-11	11/16	116	2 4/9	2	2	1	2/5	1/2	1 2/3	1	34	1 1/3	1 2/9	1/2	5/16	0,56	
UCFB204	20															0,55	
204-12	3/4	116	2 4/9	2	2	1	2/5	1/2	1 2/3	1	34	1 1/3	1 2/9	1/2	5/16	0,55	
UCFB205	25	116	68	52	56	27	10	13	45	27	34	35,8	34,1	14,3	M8	0,64	
205-13	13/16															0,67	
205-14	7/8	4 4/7	2 2/3	2	2 1/5	1	2/5	1/2	1 7/9	1	40	1 2/5	1 1/3	4/7	5/16	0,66	
205-15	15/16															0,64	
205-16	1															0,63	
UCFB206	30	130	78	55	65	31	10	13	50	29	40	40,2	38,1	15,9	M8	0,88	
206-17	1-1/16															0,89	
206-18	1-1/8	5 1/8	3	2 1/6	2 5/9	1 2/9	2/5	1/2	2	1 1/7	46	1 4/7	1 1/2	5/8	5/16	0,90	
206-19	1-3/16															0,88	
206-20	1-1/4															0,87	
UCFB207	35	144	90	62	70	34	10	15	55	32	46	44,4	42,9	17,5	M8	1,24	
207-20	1-1/4															1,31	
207-21	1-5/16	5 2/3	3 1/2	2 4/9	2 3/4	1 1/3	2/5	18	2 1/6	1 1/4	50	1 3/4	1 2/3	2/3	5/16	1,28	
207-22	1-3/8															1,25	
207-23	1-7/16															1,22	
UCFB208	40	164	100	72	78	36	12	16	60	41	50	51,2	49,2	19	M10	1,66	
208-24	1-1/2	6 1/2	4	2 5/6	3	1 3/7	1/2	19	2 1/3	1 3/5	54	2	2	3/4	3/8	1,70	
208-25	1-9/16															1,67	
UCFB209	45	174	106	76	80	38	12	18	65	43	54	52,2	49,2	19	M10	1,92	
209-26	1-5/8															2,02	
209-27	1-11/16	6 6/7	4 1/6	3	3 1/7	1 1/2	1/2	20	2 5/9	1 2/3	58	2	2	3/4	3/8	1,98	
209-28	1-3/4															1,94	
UCFB210	50	184	112	82	86	40	12	18	68	46	58	54,6	51,6	19	M10	2,21	
210-29	1-13/16															2,33	
210-30	1-7/8	7 1/4	4 2/5	3 2/9	3 2/5	1 4/7	1/2	21	2 2/3	1 4/5	62	2 1/7	2	3/4	3/8	2,38	
210-31	1-15/16															2,23	
210-32	2															2,19	

Mounted Ball Bearing

DATA TABLE - UCFB2



Part number	Dimensions (mm/in.)															Bolt size	Weight
	d	w	b	k	a	l	s	g	h	j	e	z	B	n	mm/in.	Kg	
UCFB211	55	207	130	86	90	43	14	18	78	50	62	58,4	55,6	22,2	M12	3,10	
211-32	2	8 1/7	5 1/8	3 2/5	3 1/2	1 2/3	5/9	22	3	2	66	2 2/7	2 1/5	7/8	7/16	3,25	
211-33	2-1/16															3,19	
211-34	2-1/8															3,15	
211-35	2-3/16															3,08	
UCFB212	60	223	140	90	94	48	14	18	84	55	66	68,7	65,1	25,4	M12	3,87	
212-36	2-1/4	8 7/9	5 1/2	3 1/2	3 5/7	1 8/9	5/9	25	3 1/3	2 1/6	70	2 5/7	2 4/7	1	7/16	4,00	
212-37	2-5/16															3,92	
212-38	2-3/8															3,85	
212-39	2-7/16															3,78	
UCFB213	65	244	155	64	100	50	14	20	92	60	70	69,7	65,1	25,4	M12	4,97	
213-40	2-1/2	9 3/5	6 1/9	2 1/2	4	2	5/9	27	3 5/8	2 1/3	2 3/4	2 3/4	2 4/7	1	7/16	5,06	
213-41	2-9/16															4,97	

Mounted Ball Bearing

DATA TABLE - UCFC2

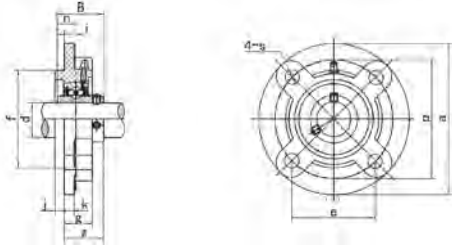

Part number	Dimensions (mm/in.)														Bolt size	Weight										
	d	a	p	e	i	s	j	k	g	f	z	t	b	n	mm/in.	Kg										
UCFC201	12	100	78	55,1	10	12	5	7	20,5	62	28,3	32,5	31,0	12,7	M10	0,70										
201-8	1/2	3-15/16	3-5/64	2-11/64	25/64	15/32	13/64	9/32	13/16	2.4409	1-1/8	1-9/32	1.2205	0.500	3/8	0,69										
UCFC202	15	100	78	55,1	10	12	5	7	20,5	62	28,3	32,5	31,0	12,7	M10	0,69										
202-9	9/16	3-15/16	3-5/64	2-11/64	25/64	15/32	13/64	9/32	13/16	2.4409	1-1/8	1-9/32	1.2205	0.500	3/8	0,69										
202-10	5/8															0,69										
UCFC203	17	100	78	55,1	10	12	5	7	20,5	62	28,3	32,5	31,0	12,7	M10	0,68										
203-11	11/16	3-15/16	3-5/64	2-11/64	25/64	15/32	13/64	9/32	13/16	2.4409	1-1/8	1-9/32	1.2205	0.500	3/8	0,67										
UCFC204	20	100	78	55,1	10	12	5	7	20,5	62	28,3	32,5	31,0	12,7	M10	0,66										
204-12	3/4	3-15/16	3-5/64	2-11/64	25/64	15/32	13/64	9/32	13/16	2.4409	1-1/8	1-9/32	1.2205	0.500	3/8	0,66										
UCFC205	25	115	90	63,6	10	12	6	7	21	70	29,8	34,0	34,1	14,3	M10	0,89										
205-13	13/16	4-17/32	3-35/64	2-1/2	25/64	15/32	15/64	9/32	53/64	2.7559	1-11/64	1-11/32	1.3425	0.563	3/8	0,92										
205-14	7/8															0,91										
205-15	15/16															0,89										
205-16	1															0,88										
UCFC206	30															125	100	70,7	10	12	8	8	23	80	32,2	36,5
206-17	1-1/16	4-59/64	3-15/16	2-25/32	25/64	15/32	5/16	5/16	29/32	3.1496	1-17/64	1-7/16	1.5000	0.626	3/8	1,19										
206-18	1-1/8															1,20										
206-19	1-3/16															1,18										
206-20	1-1/4															1,17										
UCFC207	35															135	110	77,8	11	14	8	9	26	90	36,4	41,0
207-20	1-1/4	5-5/16	4-21/64	3-1/16	7/16	35/64	5/16	23/64	1-1/32	3.5433	1-7/16	1-5/8	1.6890	0.689	7/16	1,59										
207-21	1-5/16															1,56										
207-22	1-3/8															160	125	25	18	44	19	60	57	22	M16	1,53
207-23	1-7/16															6-5/16	4-59/64	63/64	23/32	1-23/32	3/4	2-23/64	2.2441	0.866	5/8	1,50
UCFC208	40															145	120	84,8	11	14	10	9	26	100	41,2	45,5
208-24	1-1/2	5-45/64	4-23/32	3-11/32	7/16	35/64	25/64	23/64	1-1/32	3.9370	1-5/8	1-51/64	1.9370	0.748	7/16	1,89										
208-25	1-9/16															1,86										
UCFC209	45	160	132	93,3	10	16	12	14	26	105	40,2	44,5	49,2	19,0	M14	2,53										
209-26	1-5/8	6-19/64	5-13/64	3-43/64	25/64	5/8	15/32	35/64	1-1/32	4.1339	1-37/64	1-3/4	1.9370	0.748	1/2	2,63										
209-27	1-11/16															2,59										
209-28	1-3/4															2,55										
UCFC210	50															165	138	97,6	10	16	12	14	28	110	42,6	47,5
210-29	1-13/16	6-1/2	5-7/16	3-27/32	25/64	5/8	15/32	35/64	1-7/64	4.3307	1-11/16	1-7/8	2.0315	0.748	1/2	2,90										
210-30	1-7/8															2,85										
210-31	1-15/16															2,80										
210-32	2															2,76										

Mounted Ball Bearing

DATA TABLE - UCFC2



Part number	Dimensions (mm/in.)															Bolt size	Weight
	d	a	p	e	i	s	j	k	g	f	z	t	b	n	mm/in.	Kg	
UCFC211	55	185	150	106,1	13	19	12	15	31	125	46,4	51,0	55,6	22,2	M16	3,86	
211-32	2	7-9/32	5-29/32	4-3/16	33/64	3/4	15/32	19/32	1-7/32	4.9213	1-53/64	2-1/64	2.1890	0.874	5/8	4,01	
211-33	2-1/16			178	36				25	61	25		81		78	33	3,95
211-34	2-1/8	226	8-29/32	6-1/64	1-27/64	31/32	2-13/32	63/64	3-3/16	3.0708	3.0708	1.299			M22	3,91	
211-35	2-3/16	178													36	25	61
UCFC212	60	195	160	113,1	17	19	12	15	36	135	56,7	61,5	65,1	25,4	M16	4,69	
212-36	2-1/4	7-11/16	6-19/64	4-29/64	43/64	3/4	15/32	19/32	1-27/64	5.3150	2-15/64	2-27/64	2.5630	1.000	5/8	4,82	
212-37	2-5/16	236		184	39	25		66	25	89	82		32		4,74		
212-38	2-3/8	9-19/32	6-19/64	7-1/4	1-17/32	31/32	2-19/32	63/64	3-1/2	3.2283	3.2283	1.260			7/8	4,67	
212-39	2-7/16														184	39	25
UCFC213	65	205	170	120,2	16	19	14	15	36	145	55,7	60,5	65,1	25,4	M16	5,30	
213-40	2-1/2	8-5/64	6-11/16	4-47/64	5/8	3/4	35/64	19/32	1-27/64	5.708	1-3/16	2-25/64	2.5630	1.000	5/8	5,39	
213-41	2-9/16	250		196	38	27		68	31	90	86		34		5,30		
UCFC214	70	215	177	125,1	17	19	14	18	40	150	61,4	67,5	74,6	30,2	M16	6,46	
214-42	1-5/8	8-15/32	6-31/32	4-59/64	43/64	3/4	35/64	23/32	1-37/64	5.9055	2-13/32	2-21/32	2.9370	1.189	5/8	6,67	
214-43	1-11/16	10-1/4		8-1/32	1-47/64	1-1/16		2-29/32	1-7/32	3-15/16	3.7795		1.575		6,47		
214-44	1-3/4														1	6,47	
UCFC215	75	220	184	130,1	18	19	16	18	40	160	62,5	67,5	77,8	33,3	M16	6,86	
215-45	2-13/16	8-21/32	7-1/4	5-1/8	23/32	3/4	5/8	23/32	1-37/64	6.2992	2-15/32	2-21/32	3.0630	1.311	5/8	6,86	
215-46	2-7/8			12-7/8	10-5/16	3-15/32		1-1/16	1-3/16	1-19/64	7-51/64		2.858		7,11		
215-47	2-15/16	290	228	59	30			94	35	121	103	41			M30	7,00	
215-48	3	11-13/32	8-31/32	2-21/64	1-3/16			3-11/16	1-3/3	4-49/64	4.0551	1.614			1-1/8	6,80	
UCFC216	80	240	200	141,4	18	23	16	18	42	170	67,3	72,5	82,6	33,3	M20	8,47	
216-49	3-1/16	9-29/64	7-7/8	5-9/16	23/32	29/32	5/8	23/32	1-21/32	6.6929	2-21/32	2-55/64	3.2520	1.311	3/4	8,65	
216-50	3-1/8	10-1/4		8-1/32	1-47/64	1-1/16		2-29/32	1-7/32	3-15/16	3.7795		1.575		8,52		
216-51	3-3/16														1	8,39	
UCFC217	85	250	208	147,1	18	23	18	20	45	180	69,6	74,6	85,7	34,1	M20	10,18	
217-52	3-1/4	9-27/32	8-3/16	5-51/64	23/32	29/32	23/32	25/32	1-25/32	7.0866	2-3/4	2-15/16	3.3740	1.343	3/4	10,30	
217-53	3-5/16	10-1/4		8-1/32	1-47/64	1-1/16		2-29/32	1-7/32	3-15/16	3.7795		1.575		10,26		
217-55	3-7/16														1	9,97	
UCFC218	90	265	220	155,5	22	23	18	20	50	190	78,3	83,5	96,0	39,7	M20	12,24	
218-56	3-1/2	10-7/16	8-21/32	6-1/8	55/64	29/32	23/32	25*32	1-31/32	7.4803	3-3/32	3-9/32	3.7795	1.5630	3/4	12,35	

Mounted Ball Bearing

DATA TABLE - UKFC2

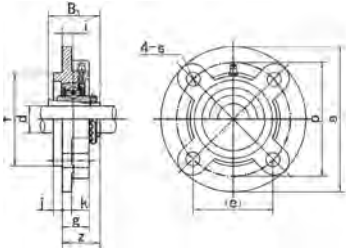

Part number	Dimensions (mm/in.)													Bolt size	Weight
	d	a	p	e	i	s	j	k	g	f	z	B ₁	mm/in.	Kg	
UKFC205 ; H2305	20	115	90	63,6	10	12	6	7	21	70	29,5	35	M10	0,93	
205 ; HE2305	3/4	4-17/32	3-35/64	2-1/2	25/64	15/32	15/64	9/32	53/64	2.7559	1-5/32	1.378	3/8		
UKFC206 ; H2306	25	125	100	70,7	10	12	8	8	23	80	31	38	M10	1,24	
206 ; HE2306	1	4-59/64	3-15/16	2-25/32	25/64	15/32	5/16	5/16	29/32	3.1496	1-7/32	1.496	3/8		
UKFC207 ; H2307	30	135	110	77,8	11	14	8	9	26	90	33,5	43	M12	1,60	
207 ; HS2307	1-1/8	5-5/16	4-21/64	3-1/16	7/16	35/64	5/16	23/64	1-1/32	3.5433	1-5/16	1.693	7/16		
UKFC208 ; H2308	35	145	120	84,8	11	14	10	9	26	100	35,5	46	M12	1,92	
208 ; HE2308	1-1/4	5-45/64	4-23/32	3-11/32	7/16	35/64	25/64	23/64	1-1/32	3.9370	1-25/64	1.811	7/16		
UKFC209 ; H2309	40	160	132	93,3	10	16	12	14	26	105	36	50	M14	2,65	
209 ; HA2309	1-7/16														
209 ; HE2309	1-1/2	6-19/64	5-13/64	3-43/64	25/64	5/8	15/32	35/64	1-1/32	4.1339	1-27/64	1.969	1/2		
UKFC210 ; H2310	45	165	138	97,6	10	16	12	14	28	110	37,5	55	M14	2,96	
210 ; HA2310	1-11/16														
210 ; HE2310	1-3/4	6-1/2	5-7/16	3-27/32	25/64	5/8	15/32	35/64	1-7/64	4.3307	1-15/32	2.165	1/2		
UKFC211 ; H2311	50	185	150	106,1	13	19	12	15	31	125	41,5	59	M16	4,02	
211 ; HA2311	1-15/16														
211 ; HE2311	2	7-9/32	5-29/32	4-3/16	33/64	3/4	15/32	19/32	1-7/32	4.9213	1-41/64	2.323	5/8		
UKFC212 ; H2312	55	195	160	113,1	17	19	12	15	36	135	48	62	M16	4,77	
212 ; HS2312	2-1/8	7-11/16	6-19/64	4-29/64	43/64	3/4	15/32	19/32	1-27/64	5.3150	1-57/64	2.441	5/8		
UKFC213 ; H2313	60	205	170	120,2	16	19	14	15	36	145	49	65	M16	5,41	
213 ; HA2313	2-3/16														
213 ; HE2313	2-1/4	8-5/64	6-11/16	4-47/64	5/8	3/4	35/64	19/32	1-27/64	5.708	1-15/16	2.559	5/8		
UKFC215 ; H2315	65	220	184	130,1	18	19	16	18	40	160	53,5	73	M16	7,25	
215 ; HA2315	2-7/16														
215 ; HE2315	2-1/2	8-21/32	7-1/4	5-1/8	23/32	3/4	5/8	23/32	1-37/64	6.2992	2-7/64	2.874	5/8		
UKFC216 ; H2316	70	240	200	141,4	18	23	16	18	42	170	57	78	M20	8,90	
216 ; HA2316	2-11/16														
216 ; HE2316	2-3/4	9-29/64	7-7/8	5-9/16	23/32	29/32	5/8	23/32	1-21/32	6.6929	2-1/4	3.071	3/4		

Mounted Ball Bearing

DATA TABLE - UKFC2



Part number	Dimensions (mm/in.)													Bolt size	Weight
	d	a	p	e	i	s	j	k	g	f	z	B ₁	mm/in.	Kg	
UKFC217 ; H2317	75	250	208	147,1	18	23	18	20	45	180	59	82	M20	10,60	
217 ; HA2317	2-15/16	9-27/32	8-3/16	5-51/64	23/32	29/32	23/32	25/32	1-25/32	7.0866	2-21/64	3.228	3/4		
217 ; HE2317	3														
UKFC218 ; H2318	80	265	220,0	155,5	22	23	18	20	50	190	64,5	86	M20	12,54	
218 ; HA2318	3-3/16	10-7/16	8-21/32	6-1/8	55/64	29/32	23/32	25/32	1-31/32	7.4803	3-35/64	3.386	3/4		

Mounted Ball Bearing

DATA TABLE - UCFL2

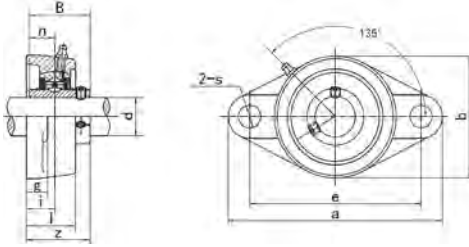

Part number	Dimensions (mm/in.)											Bolt size	Weight									
	d	a	e	i	g	l	s	b	z	B	n	mm/in.	Kg									
UCFL201	12	113	90	15	11	25,5	12	60	33,3	31,0	12,7	M10	0,45									
201-8	1/2	4-7/16	3-35/64	19/32	7/16	1	15/32	2-3/8	1-5/16	1.2205	0.500	3/8	0,44									
UCFL202	15	113	90	15	11	25,5	12	60	33,3	31,0	12,7	M10	0,44									
202-9	9/16	4-7/16	3-35/64	19/32	7/16	1	15/32	2-3/8	1-5/16	1.2205	0.500	3/8	0,44									
202-10	5/8												0,44									
UCFL203	17	113	90	15	11	25,5	12	60	33,3	31,0	12,7	M10	0,43									
203-11	11/16	4-7/16	3-35/64	19/32	7/16	1	15/32	2-3/8	1-5/16	1.2205	0.500	3/8	0,42									
UCFL204	20	113	90	15	11	25,5	12	60	33,3	31,0	12,7	M10	0,40									
204-12	3/4	4-7/16	3-35/64	19/32	7/16	1	15/32	2-3/8	1-5/16	1.2205	0.500	3/8	0,40									
UCFL205	25	130	99	16	13	27	16	68	35,8	34,1	14,3	M14	0,58									
205-13	13/16	5-1/8	3-57/64	5/8	1/2	1-1/16	5/8	2-11/16	1-13/32	1.3425	0.563	1/2	0,62									
205-14	7/8												0,61									
205-15	15/16												0,59									
205-16	1												0,58									
UCFL206	30	148	117	18	13	31	16	80	40,2	38,1	15,9	M14	0,83									
206-17	1-1/16	5-13/16	4-39/64	45/64	1/2	1-7/32	5/8	3-5/32	1-19/32	1.5000	0.626	1/2	0,84									
206-18	1-1/8												0,85									
206-19	1-3/16												0,83									
206-20	1-1/4												0,82									
UCFL207	35												161	130	19	14	34	16	90	44,4	42,9	17,5
207-20	1-1/4	6-11/32	5-1/8	3/4	35/64	1-11/32	5/8	3-35/64	1-3/4	1.6890	0.689	1/2	1,16									
207-21	1-5/16												1,13									
207-22	1-3/8												160	125	25	19	60	18	57	22	M16	1,10
207-23	1-7/16												6-5/16	4-59/64	63/64	3/4	2-23/64	23/32	2.2441	0.866	5/8	1,07
UCFL208	40												175	144	21	14	36	16	100	51,2	49,2	19,0
208-24	1-1/2	6-7/8	5-43/64	53/64	35/64	1-13/32	5/8	3-15/16	2-1/64	1.9370	0.748	1/2	1,46									
208-25	1-9/16												1,43									
UCFL209	45	188	148	22	15	38	19	108	52,2	49,2	19,0	M16	1,75									
209-26	1-5/8	7-13/32	5-53/64	55/64	19/32	1-1/2	3/4	4-1/4	2-1/16	1.9370	0.748	5/8	1,85									
209-27	1-11/16												1,81									
209-28	1-3/4												1,77									
UCFL210	50												197	157	22	15	40	19	115	54,6	51,6	19,0
210-29	1-13/16	7-3/4	6-3/16	55/64	19/32	1-37/64	3/4	4-17/32	2-5/32	2.0315	0.748	5/8	2,14									
210-30	1-7/8												2,09									
210-31	1-15/16												2,04									
210-32	2												2,00									

Mounted Ball Bearing

DATA TABLE - UCFL2



Part number	Dimensions (mm/in.)											Bolt size mm/in.	Weight Kg									
	d	a	e	i	g	l	s	b	z	B	n											
UCFL211	55	224	184	25	18	43	19	130	58,4	55,6	22,2	M16	2,79									
211-32	2	8-13/16	7-1/4	63/64	23/32	1-11/16	3/4	5-1/8	2-5/16	2.1890	0.874	5/8	2,94									
211-33	2-1/16												2,88									
211-34	2-1/8												226	178	36	25	81	25	78	33	M22	2,84
211-35	2-3/16												8-29/32	6-1/64	1-27/64	63/64	3-3/16	31/32	3.0708	1.299	7/8	2,77
UCFL212	60	250	202	29	18	48	23	140	68,7	65,1	25,4	M20	3,65									
212-36	2-1/4	9-27/32	7-61/64	1-9/64	23/32	1-7/8	29/32	5-1/2	2-23/32	2.5630	1.000	3/4	3,78									
212-37	2-5/16	236	184	39	25	89	25		82	32		M22	3,70									
212-38	2-3/8	9-19/32	7-1/4	1-17/32	63/64	3-1/2	31/32		3.2283	1.260		7/8	3,63									
212-39	2-7/16											3,56										
UCFL213	65	258	210	30	22	50	23	155	69,7	65,1	25,4	M20	4,56									
213-40	2-1/2	10-5/32	8-17/64	1-3/16	7/8	1-31/32	29/32	6-3/32	2-3/4	2.5630	1.000	3/4	4,65									
213-41	2-9/16	250	196	38	31	90	27		86	34		M27	4,56									
UCFL214	70	265	216	31	22	54	23	160	75,4	74,6	30,2	M20	5,12									
214-42	2-5/8	10-7/16	8-1/2	1-7/32	7/8	2-1/8	29/32	6-5/16	2-31/32	2.9370	1.189	3/4	5,33									
214-43	2-11/16	10-1/4	8-1/32	1-47/64	1-7/32	3-15/16	1-1/16		3.7795	1.575		1	5,23									
214-44	2-3/4			5,13																		
UCFL215	75	275	225	34	22	56	23		165	78,5		77,8	33,3	M20	5,64							
215-45	2-13/16	10-13/16	8-55/64	1-11/32	7/8	2-7/32	29/32	6-1/2	3-3/32	3.0630	1.311	3/4	5,61									
215-46	2-7/8								12-7/8	10-5/16			1-3/16	1-19/64	3-15/32	7-51/64	2.858	5,86				
215-47	2-15/16								290	228			59	35	121	30	103	41	M30	5,75		
215-48	3								11-13/32	8-31/32			2-21/64	1-3/3	4-49/64	1-3/16	4.0551	1.614	1-1/8	5,55		
UCFL216	80	290	233	34	22	58	25	180	83,3	82,6	33,3	M22	6,91									
216-49	3-1/16	11-13/32	9-11/64	1-11/32	7/8	2-9/32	63/64	7-3/32	3-9/32	3.2520	1.311	7/8	7,09									
216-50	3-1/8	10-1/4	8-1/32	1-47/64	1-7/32	3-15/16	1-1/16		3.7795	1.575		1	6,96									
216-51	3-3/16											6,83										
UCFL217	85	305	248	36	24	63	25		190	87,5		85,7	34,1	M22	8,27							
217-52	3-1/4	12	9-49/64	1-27/64	15/16	2-15/32	63/64	7-15/32	3-7/16	3.3740	1.343	7/8	8,39									
217-53	3-5/16	10-1/4	8-1/32	1-47/64	1-7/32	3-15/16	1-1/16		3.7795	1.575		1	8,35									
217-55	3-7/16													8,06								
UCFL218	90	320	265	40	24	68	25		205	96,3		96,0	39,7	M22	10,13							
218-56	3-1/2	12-19/32	10-7/16	1-37/64	15/16	2-11/16	63/64	8-1/16	3-25/32	3.7795	1.5630	7/8	10,24									

Mounted Ball Bearing

DATA TABLE - UKFL2

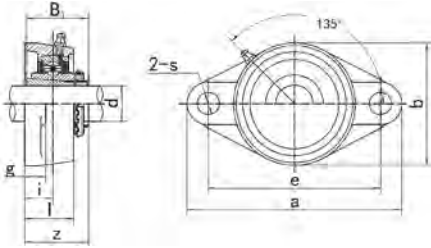

Part number	Dimensions (mm/in.)										Bolt size	Weight
	d	a	e	i	g	l	s	b	z	B ₁	mm/in.	Kg
UKFL205 ; H2305	20	130	99	16	13	27	16	68	35,5	35	M14	0,63
205 ; HE2305	3/4	5-1/8	3-5/7/64	5/8	1/2	1-1/16	5/8	2-11/16	1-25/64	1.378	1/2	
UKFL206 ; H2306	25	148	117	18	13	31	16	80	39	38	M14	0,89
206 ; HE2306	1	5-13/16	4-39/64	45/64	1/2	1-7/32	5/8	3-5/32	1-17/32	1.496	1/2	
206 ; HS2306	7/8											
UKFL207 ; H2307	30	161	130	19	14	34	16	90	42,5	43	M14	1,17
207 ; HS2307	1-1/8	6-11/32	5-1/8	3/4	35/64	1-11/32	5/8	3-35/64	1-43/64	1.693	1/2	
UKFL208 ; H2308	35	175	144	21	14	36	16	100	46,5	46	M14	1,49
208 ; HE2308	1-1/4	6-7/8	5-43/64	53/64	35/64	1-13/32	5/8	3-15/16	1-53/64	1.811	1/2	
208 ; HS2308	1-3/8											
UKFL209 ; H2309	40	188	148	22	15	38	19	108	48,5	50	M16	1,87
209 ; HA2309	1-7/16	7-13/32	5-53/64	55/64	19/32	1-1/2	3/4	4-1/4	1-29/32	1.969	5/8	
209 ; HE2309	1-1/2											
209 ; HS2309	1-5/8											
UKFL210 ; H2310	45	197	157	22	15	40	19	115	50	55	M16	2,19
210 ; HA2310	1-11/16	7-3/4	6-3/16	55/64	19/32	1-37/64	3/4	4-17/32	1-31/32	2.165	5/8	
210 ; HE2310	1-3/4											
210 ; HS2310	1-5/8											
UKFL211 ; H2311	50	224	184	25	18	43	19	130	54,5	59	M16	2,95
211 ; HA2311	1-15/16	8-13/16	7-1/4	63/64	23/32	1-11/16	3/4	5-1/8	2-9/64	2.323	5/8	
211 ; HE2311	2											
211 ; HS2311	1-7/8											
UKFL212 ; H2312	55	250	202	29	18	48	23	140	61	62	M20	3,73
212 ; HS2312	2-1/8	9-27/32	7-61/64	1-9/64	23/32	1-7/8	29/32	5-1/2	2-13/32	2.441	3/4	
UKFL213 ; H2313	60	258	210	30	22	50	23	155	64	65	M20	4,67
213 ; HA2313	2-3/16	10-5/32	8-17/64	1-3/16	7/8	1-31/32	29/32	6-3/32	2-33/64	2.559	3/4	
213 ; HE2313	2-1/4											
213 ; HS2313	2-3/8											
UKFL215 ; H2315	65	275	225	34	22	56	23	165	71	73	M20	6,00
215 ; HA2315	2-7/16	10-13/16	8-55/64	1-11/32	7/8	2-7/32	29/32	6-1/2	2-51/64	2.874	3/4	
215 ; HE2315	2-1/2											
UKFL216 ; H2316	70	290	233	34	22	58	25	180	73,5	78	M22	7,34
216 ; HA2316	2-11/16	11-13/32	9-11/64	1-11/32	7/8	2-9/32	63/64	7-3/32	2-57/64	3.071	7/8	
216 ; HE2316	2-3/4											

Mounted Ball Bearing

DATA TABLE - UKFL2



Part number	Dimensions (mm/in.)										Bolt size	Weight
	d	a	e	i	g	l	s	b	z	B ₁	mm/in.	Kg
UKFL217 ; H2317	75	305	248	36	24	63	25	190	77	82	M22	8,68
217 ; HA2317	2-15/16	12	9-49/64	1-27/64	15/16	2-15/32	63/64	7-15/32	3-1/32	3.228	7/8	
217 ; HE2317	3											
UKFL218 ; H2318	80	320	265	40	24	68	25	205	81,5	86	M22	10,43
218 ; HA2318	3-3/16	12-19/32	10-7/16	1-37/64	15/16	2-11/16	63/64	8-1/16	3-13/64	3.386	7/8	

Mounted Ball Bearing

DATA TABLE - UCT2

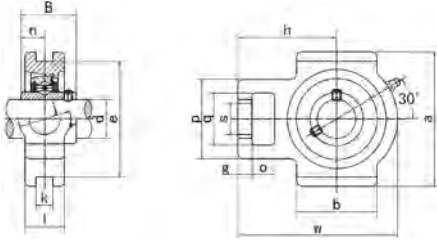

Part number	Dimensions (mm/in.)																Weight
	d	o	g	p	q	s	b	k	e	a	w	j	l	h	B ₁	n	Kg
UCT201	12	16	10	51	32	19	51	12	76	89	94	32	21	61	31	12,7	0,77
201-8	1/2	5/8	5/9	5/10	5/11	5/12	5/13	5/14	5/15	5/16	5/17	5/18	5/19	5/20	5/22	5/23	0,76
UCT202	15																0,76
202-9	9/16	5/8	5/9	5/10	5/11	5/12	5/13	5/14	5/15	5/16	5/17	5/18	5/19	5/20	5/22	5/23	0,76
202-10	5/8																0,76
UCT203	17																0,75
203-11	11/16	5/8	5/9	5/10	5/11	5/12	5/13	5/14	5/15	5/16	5/17	5/18	5/19	5/20	5/22	5/23	0,74
UCT204	20																0,73
204-12	3/4	5/8	5/9	5/10	5/11	5/12	5/13	5/14	5/15	5/16	5/17	5/18	5/19	5/20	5/22	5/23	0,73
UCT205	25	16	10	51	32	19	51	12	76	89	97	32	24	62	34,1	14,3	0,80
205-13	13/16																0,84
205-14	7/8	25/63	25/64	2-1/64	1-1/4	3/4	2-1/64	15/32	2-63/64	3-1/2	3-13/16	1-1/4	15/16	2-7/16	1.3425	0.563	0,83
205-15	15/16																0,81
205-16	1																0,80
UCT206	30	16	10	56	37	22	57	12	89	102	113	37	28	70	38,1	15,9	1,22
206-17	1-1/16	5/8	25/64	2-7/32	1-29/64	55/64	2-1/4	15/32	3-1/2	4-1/64	4-29/64	1-29/64	1-3/32	2-3/4	1.5000	0.626	1,23
206-18	1-1/8																1,24
206-19	1-3/16	5/8	25/64	2-7/32	1-29/64	55/64	2-1/4	15/32	3-1/2	4-1/64	4-29/64	1-29/64	1-3/32	2-3/4	1.5000	0.626	1,22
206-20	1-1/4																1,21
UCT207	35	16	13	64	37	22	64	12	89	102	129	37	30	78	42,9	17,5	1,57
207-20	1-1/4	5/8															1,63
207-21	1-5/16		33/64	2-33/64	1-29/64	55/64	2-33/64	15/32	3-1/2	4-1/64	5-5/64	1-29/64	1-3/16	3-5/64	1.6890	0.689	1,60
207-22	1-3/8	5/8															1,57
207-23	1-7/16		33/64	2-33/64	1-29/64	55/64	2-33/64	15/32	3-1/2	4-1/64	5-5/64	1-29/64	1-3/16	3-5/64	1.6890	0.689	1,54
UCT208	40	19	16	83	49	29	83	16	102	114	144	49	33	89	49,2	19	2,31
208-24	1-1/2	3/4	5/8	3-17/64	1-15/16	1-9/64	3-17/64	5/8	4-1/64	4-31/64	5-43/64	1-15/16	1-19/64	3-1/2	1.9370	0.748	2,35
208-25	1-9/16																2,32
UCT209	45	19	16	83	49	29	83	16	102	117	144	49	35	87	49,2	19	2,34
209-26	1-5/8																2,44
209-27	1-11/16	3/4	5/8	3-17/64	1-15/16	1-9/64	3-17/64	5/8	4-1/64	4-39/64	5-43/64	1-15/16	1-3/8	3-27/64	1.9370	0.748	2,40
209-28	1-3/4																2,36
UCT210	50	19	16	83	49	29	86	16	102	117	149	49	37	90	51,6	19	2,47
210-29	1-13/16																2,59
210-30	1-7/8	3/4	5/8	3-17/64	1-15/16	1-9/64	3-17/64	5/8	4-1/64	4-39/64	5-55/64	1-15/16	1-29/64	3-35/64	2.0315	0.748	2,54
210-31	1-15/16																2,49
210-32	2																2,45

Mounted Ball Bearing

DATA TABLE - UCT2



Part number	Dimensions (mm/in.)																	Weight
	d	o	g	p	q	s	b	k	e	a	w	j	l	h	B ₁	n	Kg	
UCT211	55	25	19	102	64	35	95	22	130	146	171	64	38	106	55,6	22,2	3,74	
211-32	2																3,89	
211-33	2-1/16	63/64	3/4	4-1/64	2-33/64	1-3/8	3-3/4	55/64	5-1/8	5-3/4	6-47/64	2-33/64	1-1/2	4-11/64	2.1890	0.874	3,83	
211-34	2-1/8																3,79	
211-35	2-3/16																3,72	
UCT212	60																32	19
212-36	2-1/4																4,71	
212-37	2-5/16	1-17/64	3/4	4-1/64	2-33/64	1-3/8	4-1/64	55/64	5-1/8	5-3/4	7-41/64	2-33/64	1-21/32	4-11/16	2.5630	1.000	4,63	
212-38	2-3/8																4,56	
212-39	2-7/16																4,49	
UCT213	65																32	21
213-40	2-1/2	1-17/64	53/64	4-3/8	2-3/4	1-39/64	4-49/64	1-1/32	5-15/16	6-37/64	8-13/16	2-3/4	1-23/32	5-25/64	2.5630	1.000	6,69	
213-41	2-9/16																6,60	
UCT214	70	32	21	111	70	41	121	26	151	167	224	70	46	137	74,6	30,2	6,74	
214-42	2-5/8																6,95	
214-43	2-11/16	1-17/64	53/64	4-3/8	2-3/4	1-39/64	4-49/64	1-1/32	5-15/16	6-37/64	8-13/16	2-3/4	1-13/16	5-25/64	2.937	1.189	6,85	
214-44	2-3/4																6,75	
UCT215	75	32	21	111	70	41	121	26	151	167	232	70	48	140	77,8	33,3	7,19	
215-45	2-13/16																7,19	
215-46	2-7/8	1-17/64	53/64	4-3/8	2-3/4	1-39/64	4-49/64	1-1/32	5-15/16	6-37/64	9-9/64	2-3/4	1-57/64	5-33/64	3.0630	1.311	7,44	
215-47	2-15/16																7,33	
215-48	3																7,13	
UCT216	80																32	21
216-49	3-1/16																8,26	
216-50	3-1/8	1-17/64	53/64	4-3/8	2-3/4	1-39/64	4-49/64	1-1/32	6-1/2	7-1/4	9-1/4	2-3/4	2	5-33/64	3.2520	1.311	8,13	
216-51	3-3/16																8,00	
UCT217	85	38	29	124	73	48	157	30	173	198	260	73	54	162	85,7	34,1	10,66	
217-52	3-1/4																10,78	
217-53	3-5/16	1-1/2	1-9/64	4-7/8	2-7/8	1-57/64	6-3/16	1-3/16	6-13/16	7-51/64	10-15/64	2-7/8	2-1/8	6-3/8	3.3740	1.343	10,74	
217-55	3-7/16																10,45	
UCT218	90	40	30	130	80	48	140	30	190	215	275	80	55	170	96	39,7	12,19	
218-56	3-1/2	1-37/64	1-3/16	5-1/8	3-5/32	1-57/64	5-35/64	1-3/16	7-31/64	8-15/32	10-53/64	3-5/32	2-11/64	6-11/16	3.7795	1.5630	12,30	

Mounted Ball Bearing

DATA TABLE - UCT3

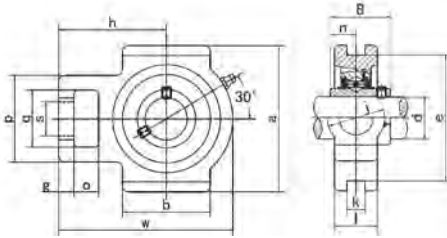

Part number	Dimensions (mm/in.)																Weight
	d	o	g	p	q	s	b	k	e	a	w	j	l	h	B	n	Kg
UCT305	25	16	14	62	36	26	51	12	80	89	122	36	26	76	38	15	1,20
305-13	13/16	5/8	5/9	2 4/9	1 3/7	1	2	1/2	3 1/7	3 1/2	4 4/5	1 3/7	1	3	1.3425	0.563	
305-14	7/8																
305-15	15/16																
305-16	1																
UCT306	30	18	16	70	41	28	57	16	90	100	137	41	28	85	43	17	1,70
306-17	1-1/16	5/7	5/8	2 3/4	1 3/5	1 1/9	2 1/4	5/8	3 1/2	4	5 2/5	1 3/5	1 1/9	3 1/3	1.5000	0.626	
306-18	1-1/8	5/7	5/8	2 3/4	1 3/5	1 1/9	2 1/4	5/8	3 1/2	4	5 2/5	1 3/5	1 1/9	3 1/3	1.5000	0.626	
306-19	1-3/16																
306-20	1-1/4																
UCT307	35																20
307-20	1-1/4	4/5	2/3	3	1 7/9	1 1/6	2 1/2	5/8	4	4 3/8	6	1 7/9	1 1/4	3 5/7	1.6890	0.689	
307-21	1-5/16																
307-22	1-3/8																
307-23	1-7/16																
UCT308	40	22	19	83	50	32	83	18	112	124	162	50	34	100	52	19	2,90
308-24	1-1/2	6/7	3/4	3 1/4	2	1 1/4	3 1/4	5/7	4 2/5	4 7/8	6 3/8	2	1 1/3	4	1.9370	0.748	
308-25	1-9/16																
UCT309	45	24	20	90	55	34	83	18	125	138	178	55	38	110	57	22	4,00
309-26	1-5/8	1	4/5	3 1/2	2 1/6	1 1/3	3 1/4	5/7	5	5 3/7	7	2 1/6	1 1/2	4 1/3	1.9370	0.748	
309-27	1-11/16																
309-28	1-3/4																
UCT310	50																27
310-29	1-13/16	1	6/7	3 6/7	2 2/5	1 1/2	3 2/5	4/5	5 1/2	6	7 5/9	2 2/5	1 4/7	4 2/3	2.0315	0.748	
310-30	1-7/8																
310-31	1-15/16																
310-32	2																
UCT311	55	29	23	105	66	39	95	22	150	163	207	66	44	127	66	25	6,20
311-32	2	1 1/7	1	4 1/7	2 3/5	1 1/2	3 3/4	6/7	6	6 3/7	8 1/7	2 3/5	1 3/4	5	2.1890	0.874	
311-33	2-1/16																
311-34	2-1/8																
311-35	2-3/16																
UCT312	60	31	25	113	71	41	102	22	160	178	220	71	46	135	71	26	7,50
312-36	2-1/4	1 2/9	1	4 4/9	2 4/5	1 3/5	4	6/7	6 2/7	7	8 2/3	2 4/5	1 4/5	5 1/3	2.5630	1.000	
312-37	2-5/16																
312-38	2-3/8																
312-39	2-7/16																

Mounted Ball Bearing

DATA TABLE - UCT3



Part number	Dimensions (mm/in.)																Weight	
	d	o	g	p	q	s	b	k	e	a	w	j	l	h	B ₁	n	Kg	
UCT313	65	32	27	116	70	43	121	26	170	190	238	80	50	146	75	30	9,30	
313-40	2-1/2	1 1/4	1	4 4/7	2 3/4	1 2/3	4 3/4	1	6 2/3	7 1/2	9 3/8	3 1/7	2	5 3/4	2.5630	1.000		
313-41	2-9/16																	
UCT314	70	36	27	130	85	46	121	26	180	202	252	90	52	155	78	33	10,90	
314-42	2-5/8	1 3/7	1	5 1/8	3 1/3	1 4/5	4 3/4	1	7	8	10	3 1/2	2	6 1/9	2.9370	1.189		
314-43	2-11/16																	
314-44	2-3/4																	
314-45	2-5/8																	
UCT315	75	36	27	132	85	46	121	26	192	216	262	90	55	160	82	32	12,70	
315-45	2-13/16	1 3/7	1	5 1/5	3 1/3	1 4/5	4 3/4	1	7 5/9	8 1/2	10 1/3	3 1/2	2 1/6	6 2/7	3.0630	1.311		
315-46	2-7/8																	
315-47	2-15/16																	
315-48	3																	
315-49	2-13/16																	
UCT316	80	42	30	150	98	46	121	30	204	230	282	102	60	174	86	34	15,80	
316-49	3-1/16	1 2/3	1 1/6	6	3 6/7	1 4/5	4 3/4	1 1/6	8	9	11 1/9	4	2 1/3	6 6/7	3.2520	1.3110		
316-50	3-1/8																	
316-51	3-3/16																	
316-52	3-1/8																	
UCT317	85	42	32	152	98	53	157	32	214	240	298	102	64	183	96	40	18,60	
317-52	3-1/4	1 2/3	1 1/4	6	3 6/7	2	6 1/6	1 1/4	8 3/7	9 4/9	11 3/4	4	2 1/2	7 1/5	3.3740	1.3430		
317-53	3-5/16																	
317-55	3-7/16																	
317-56	3-1/4																	
UCT318	90	46	32	160	106	53	140	32	228	255	312	110	66	192	96	40	21,00	
318-55	3-1/2	1 4/5	1 1/4	6 2/7	4 1/6	2	5 1/2	1 1/4	9	10	12 2/7	4 1/3	2 3/5	7 5/9	3.7795			
318-56																		
UCT319	95	46	33	165	106	57		35	240	270	322	110	72	197	103	41	24,60	
319-58	3-5/8	1 4/5	1 2/7	6 1/2	4 1/6	2 1/4	0	1 3/8	9 4/9	10 5/8	12 2/3	4 1/3	2 5/6	7 3/4	4.0551	1.6142		
319-59	3-11/16																	
319-60	3-3/4																	
319-61	3-5/8																	
UCT320	100	48	32	175	115	59		0	35	260	290	345	120	75	210	108	42	29,90
320-64	4	1 8/9	1 1/4	6 8/9	4 1/2	2 1/3		0	1 3/8	10 1/4	11 3/7	13 4/7	4 5/7	3	8 1/4	4.2520	1.6535	
UCT322	110	52	38	185	125	65		0	38	285	320	385	130	80	235	117	46	39,49
322-64	2	1 1/2	7 2/7	5	2 5/9		0	1 1/2	11 2/9	12 3/5	15 1/6	5 1/8	3 1/7	9 1/4	4.6063	1.8110		
UCT324	120	60	42	210	140	70		0	45	320	355	432	140	90	267	126	51	54,20
324-64	2 1/3	1 2/3	8 1/4	5 1/2	2 3/4		0	1 7/9	12 3/5	14	17	5 1/2	3 1/2	10 1/2	4.9606	2.0079		
UCT326	130	65	45	220	150	75		0	50	350	385	465	150	100	285	135	54	68,40
326-64	2 5/9	1 7/9	8 2/3	6	3		0	2	13 7/9	15 1/6	18 1/3	6	4	11 2/9	5.3150	2.1260		
UCT328	140	70	50	230	160	80		0	50	380	415	515	155	100	315	145	59	82,90
328-64	2 3/4	2	9	6 2/7	3 1/7		0	2	15	16 1/3	20 2/7	6 1/9	4	12 2/5	5.7087	2.3228		

Mounted Ball Bearing

DATA TABLE - UCTX

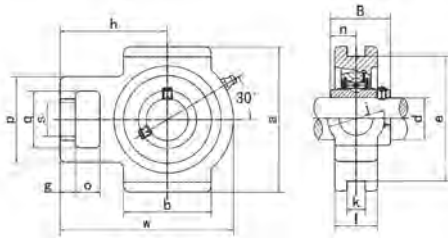

Part number	Dimensions (mm/in.)																Weight Kg
	d	o	g	p	q	s	b	k	e	a	w	j	l	h	B	n	
UCTX05	25	16	12	56	37	22	57	12	89	102	113	28	37	70	38,1	15,9	1,30
X05-13	13/16	5/8	1/2	2 1/5	1 1/2	6/7	2 1/4	1/2	3 1/2	4	4 4/9	1 1/9	1 1/2	2 3/4	1 1/2	5/8	
X05-14	7/8																
X05-15	15/16																
X05-16	1																
UCTX06	30	16	15	64	37	22	64	12	89	102	129	30	37	78	42,9	17,5	1,60
X06-17	1-1/16	5/8	3/5	2 1/2	1 1/2	6/7	2 1/2	1/2	3 1/2	4	5	1 1/6	1 1/2	3	1 2/3	2/3	
X06-18	1-1/8																
X06-19	1-3/16																
X06-20	1-1/4																
UCTX07	35	19	17	83	49	29	83	16	102	114	144	36	49	88	49,2	19	2,60
X07-20	1-1/4	3/4	2/3	3 1/4	2	1 1/7	3 1/4	5/8	4	4 1/2	5 2/3	1 3/7	2	3 1/2	2	3/4	
X07-21	1-5/16																
X07-22	1-3/8																
X07-23	1-7/16																
UCTX08	40	19	17	83	49	29	83	16	102	117	144	36	49	87	49,2	19	2,50
X08-24	1-1/2	3/4	2/3	3 1/4	2	1 1/7	3 1/4	5/8	4	4 3/5	5 2/3	1 3/7	2	3 3/7	2	3/4	
X08-25	1-9/16																
UCTX09	45	19	18	83	49	29	86	16	102	117	151	38	49	92	51,6	19	2,70
X09-26	1-5/8	3/4	5/7	3 1/4	2	1 1/7	3 2/5	5/8	4	4 3/5	6	1 1/2	2	3 5/8	2	3/4	
X09-27	1-11/16																
X09-28	1-3/4																
X09-29	1-13/16																
UCTX10	50	25	21	102	64	35	95	22	130	146	171	42	64	106	55,6	22,2	4,20
X10-30	1-7/8	1	5/6	4	2 1/2	1 3/8	3 3/4	6/7	5 1/8	5 3/4	6 3/4	1 2/3	2 1/2	4 1/6	2 1/5	7/8	
X10-31	1-15/16																
X10-32	2																
UCTX11	55	32	21	102	64	35	102	22	130	146	194	44	64	119	65,1	25,4	4,90
X11-33	2-1/16	1 1/4	5/6	4	2 1/2	1 3/8	4	6/7	5 1/8	5 3/4	7 2/3	1 3/4	2 1/2	4 2/3	2 4/7	1	
X11-34	2-1/8																
X11-35	2-3/16																
X11-36	2-1/4																
X11-37	2-5/16																
UCTX12	60	32	23	111	70	41	121	26	151	146	224	48	70	137	65,1	25,4	7,30
X12-38	2-3/8	1 1/4	1	4 3/8	2 3/4	1 3/5	4 3/4	1	6	5 3/4	8 5/6	1 8/9	2 3/4	5 2/5	2 4/7	1	
X12-39	2-7/16																

Mounted Ball Bearing

DATA TABLE - UCTX



Part number	Dimensions (mm/in.)																Weight
	d	o	g	p	q	s	b	k	e	a	w	j	l	h	B	n	Kg
UCTX13	65	32	23	111	70	41	121	26	151	167	224	48	70	137	74,6	30,2	7,10
X13-40	2-1/2	1 1/4	1	4 3/8	2 3/4	1 3/5	4 3/4	1	6	6 4/7	8 5/6	1 8/9	2 3/4	5 2/5	3	1 1/5	
X13-41	2-9/16																
UCTX14	70	32	23	111	70	41	121	26	151	167	232	48	70	140	77,8	33,3	7,30
X14-42	2-5/8	1 1/4	1	4 3/8	2 3/4	1 3/5	4 3/4	1	6	6 4/7	9 1/7	1 8/9	2 3/4	5 1/2	3	1 1/3	
X14-43	2-11/16																
X14-44	2-3/4																
X14-45	3																
UCTX15	75	32	23	111	70	41	121	28	165	184	235	48	70	140	82,6	33,3	8,00
X15-45	2-13/16	1 1/4	1	4 3/8	2 3/4	1 3/5	4 3/4	1 1/9	6 1/2	7 1/4	9 1/4	1 8/9	2 3/4	5 1/2	3 1/4	1 1/3	
X15-46	2-7/8																
X15-47	2-15/16																
X15-48	3																
X15-49	3-1/16																
UCTX16	80	38	30	124	73	48	157	28	173	198	260	54	73	162	85,7	34,1	11,40
X16-49	3-1/16	1 1/2	1 1/6	4 7/8	2 7/8	1 8/9	6 1/6	1 1/9	6 4/5	7 4/5	10 1/4	2 1/8	2 7/8	6 3/8	3 3/8	1 1/3	
X16-50	3-1/8																
X16-51	3-3/16																
X16-52	3-1/4																
X16-53	3-5/16																
UCTX17	85	38	30	124	73	48	157	28	173	198	260	54	73	162	96	39,7	11,30
X17-53	3-5/16	1 1/2	1 1/6	4 7/8	2 7/8	1 8/9	6 1/6	1 1/9	6 4/5	7 4/5	10 1/4	2 1/8	2 7/8	6 3/8	3 7/9	1 4/7	
X17-54	3-7/16																
X17-55	3-7/16																

Mounted Ball Bearing

DATA TABLE - UKT2

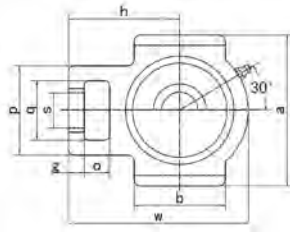
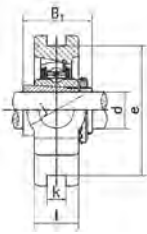

Part number	Dimensions (mm/in.)															Weight Kg
	d	o	g	p	q	s	b	k	e	a	w	j	l	h	B ₁	
UKT205 ; H2305	20	16	10	51	32	19	51	12	76	89	97	32	24	62	35	0,86
205 ; HE2305	3/4	5/8	25/64	2-1/64	1-1/4	3/4	2-1/64	15/32	2-63/64	3-1/2	3-13/16	1-1/4	15/16	2-7/16	1.378	
UKT206 ; H2306	25	16	10	56	37	22	57	12	89	102	113	37	28	70	38	1,26
206 ; HE2306	1	5/8	25/64	2-7/32	1-29/64	55/64	2-1/4	15/32	3-1/2	4-1/64	4-29/64	1-29/64	1-3/32	2-3/4	1.496	
206 ; HS2306	7/8															
UKT207 ; H2307	30	16	13	64	37	22	64	12	89	102	129	37	30	78	43	2,50
207 ; HS2307	1-1/8	5/8	33/64	2-33/64	1-29/64	55/64	2-33/64	15/32	3-1/2	4-1/64	5-5/64	1-29/64	1-3/16	3-5/64	1.693	
UKT208 ; H2308	35	19	16	83	49	29	83	16	102	114	144	49	33	89	46	2,50
208 ; HE2308	1-1/4	3/4	5/8	3-17/64	1-15/16	1-9/64	3-17/64	5/8	4-1/64	4-31/64	5-43/64	1-15/16	1-5/16	3-1/2	1.811	
208 ; HS2308	1-3/8															
UKT209 ; H2309	40	19	16	83	49	29	83	16	102	117	144	49	35	87	50	2,51
209 ; HA2309	1-7/16	3/4	5/8	3-17/64	1-15/16	1-9/64	3-17/64	5/8	4-1/64	4-39/64	5-43/64	1-15/16	1-3/8	3-27/64	1.969	
209 ; HE2309	1-1/2															
209 ; HS2309	1-5/8															
UKT210 ; H2310	45	19	16	83	49	29	86	16	102	117	149	49	37	90	55	2,60
210 ; HA2310	1-11/16	3/4	5/8	3-17/64	1-15/16	1-9/64	3-25/64	5/8	4-1/64	4-39/64	5-55/64	1-15/16	1-15/32	3-35/64	2.165	
210 ; HE2310	1-3/4															
210 ; HS2310	1-5/8															
UKT211 ; H2311	50	25	19	102	64	35	95	22	130	146	171	64	38	106	59	4,26
211 ; HA2311	1-15/16	63/64	3/4	4-1/64	2-33/64	1-3/8	3-3/4	55/64	5-1/8	5-3/4	6-47/64	2-33/64	1-1/2	4-11/64	2.323	
211 ; HE2311	2															
211 ; HS2311	1-7/8															
UKT212 ; H2312	55	32	19	102	64	35	102	22	130	146	194	64	42	119	62	5,02
212 ; HS2312	2-1/8	1-17/64	3/4	4-1/64	2-33/64	1-3/8	4-1/64	55/64	5-1/8	5-3/4	7-41/64	2-33/64	1-21/32	4-11/16	2.441	
UKT213 ; H2313	60	32	21	111	70	41	121	26	151	167	224	70	44	137	65	6,56
213 ; HA2313	2-3/16	1-17/64	53/64	4-3/8	2-3/4	1-39/64	4-49/64	1-1/32	5-15/16	6-37/64	8-13/16	2-3/4	1-23/32	5-25/64	2.559	
213 ; HE2313	2-1/4															
213 ; HS2313	2-3/8															
UKT215 ; H2315	65	32	21	111	70	41	121	26	151	167	232	70	48	140	73	7,52
215 ; HA2315	2-7/16	1-17/64	53/64	4-3/8	2-3/4	1-39/64	4-49/64	1-1/32	5-15/16	6-37/64	9-9/64	2-3/4	1-57/64	5-33/64	2.874	
215 ; HE2315	2-1/2															
215 ; HS2315	2-1/2															
UKT216 ; H2316	70	32	21	111	70	41	121	26	165	184	235	70	51	140	78	8,56
216 ; HA2316	2-11/16	1-17/64	53/64	4-3/8	2-3/4	1-39/64	4-49/64	1-1/32	6-1/2	7-1/4	9-1/4	2-3/4	2	5-33/64	3.071	
216 ; HE2316	2-3/4															
216 ; HS2316	2-3/4															
UKT217 ; H2317	75	38	29	124	73	48	157	30	173	198	260	73	54	162	82	11,38
217 ; HA2317	2-15/16	1-1/2	1-9/64	4-7/8	2-7/8	1-57/64	6-3/16	1-3/16	6-13/16	7-51/64	10-15/64	2-7/8	2-1/8	6-3/8	3.288	
217 ; HE2317	3															

Mounted Ball Bearing

DATA TABLE - UCS2 / UC2

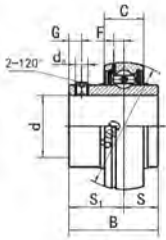

Seal options



SL Dual seal (Standard)



L Triple-lip seal (Optional)



F seal (Optional)

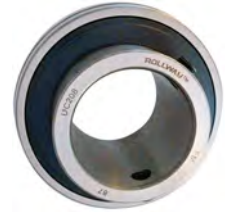

Part number	Dimensions (mm/in.)			Weight Kg
	d	D	B	

UCS201	12	40	27,4	0,12
201-8	1/2	1.5748	1.0787	0,12
UCS202	15			0,11
202-9	9/16	1.5748	1.0787	0,11
202-10	5/8			0,11
UCS203	17	1.5748	1.0787	0,10
203-11	11/16			0,10
UC201	12	47	31	0,20
201-8	1/2	1.8504	1.2205	0,19
UC202	15			0,19
202-9	9/16	1.8504	1.2205	0,19
202-10	5/8			0,19
UC203	17	1.8504	1.2205	0,18
203-11	11/16			0,17
UC204	20	47	31	0,16
204-12	3/4	1.8504	1.2205	0,16
UC205	25	52	34,1	0,19
205-13	13/16			0,23
205-14	7/8	2.0472	1.3425	0,22
205-15	15/16			0,20
205-16	1			0,19
UC206	30	62	38,1	0,30
206-17	1-1/16			0,31
206-18	1-1/8	2.4409	1.5000	0,32
206-19	1-3/16			0,30
206-20	1-1/4			0,29
UC207	35	72	42,9	0,45
207-20	1-1/4			0,51
207-21	1-5/16	2.8346	1.6890	0,48
207-22	1/3/8			0,45
207-23	1-7/16			0,42
UC208	40	80	49,2	0,60
208-24	1-1/2	3.1496	1.9370	0,64
208-25	1-9/16			0,61

Part number	Dimensions (mm/in.)			Weight Kg
	d	D	B	

UC209	45	85	49,2	0,65
209-26	1-5/8			0,75
209-27	1-11/16	3.3465	1.9370	0,71
209-28	1-3/4			0,67
UC210	50	90	51,6	0,75
210-29	1-13/16			0,87
210-30	1-7/8	3.5433	2.0315	0,82
210-31	1-15/16			0,77
210-32	2			0,73
UC211	55	100	55,6	0,99
211-32	2			1,14
211-33	2-1/16	3.9370	2.1890	1,08
211-34	2-1/8			1,07
211-35	2-3/16			0,97
UC212	60	110	65,1	1,32
212-36	2-1/4			1,52
212-37	2-5/16	4.3307	2.5630	1,44
212-38	2-3/8			1,37
212-39	2-7/16			1,30
UC213	65	120	65,1	1,70
213-40	2-1/2	4.3307	2.5630	1,79
213-41	2-9/16			1,70
UC214	70	125	74,6	1,94
214-42	2-5/8			2,15
214-43	2-11/16	4.9213	2.9370	2,05
214-44	2-3/4			1,95
UC215	75	130	77,8	2,16
215-45	2-13/16			2,16
215-46	2-7/8	5.1181	3.0630	2,41
215-47	2-15/16			2,30
215-48	3			2,10
UC216	80	140	82,6	2,65
216-49	3-1/16			2,83
216-50	3-1/8	5.5118	3.2520	2,70
216-51	3-3/16			2,57

Part number	Dimensions (mm/in.)			Weight Kg
	d	D	B	

UC217	85	150	85,7	3,29
217-52	3-1/4			3,41
217-53	3-5/16	5.9055	3.3740	3,37
217-55	3-7/16			3,08
UC218	90	160	96	4,04
218-56	3-1/2	6.2992	3.7795	4,15
UC220	100	180	108	4,56
220-64	4	7.0866	4.252	4,35

Mounted Ball Bearing

DATA TABLE - UC3

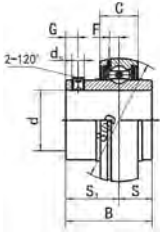

Seal options

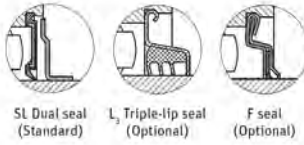

Part number	Dimensions (mm/in.)			Weight Kg
	d	D	B	
UC305	25	62	38	0,33
305-13	13/16	2.4409	1.4960	0,38
305-14	7/8			0,36
305-15	15/16	2.4409	1.4960	0,34
305-16	1			0,33
UC306	30	72	43	0,54
306-17	1-1/16	2.8346	1.6929	0,59
306-18	1-1/8	2.8346	1.6929	0,56
306-19	1-3/16			0,54
UC307	35	80	48	0,69
307-20	1-1/4			0,75
307-21	1-5/16	3.1496	1.8897	0,72
307-22	1-3/8			0,69
307-23	1-7/16			0,66
UC308	40	90	52	0,95
308-24	1-1/2	3.5433	2.0472	1,00
308-25	1-9/16			0,96
UC309	45	100	57	1,29
309-26	1-5/8			1,38
309-27	1-11/16	3.9370	2.2441	1,34
309-28	1-3/4			1,29
UC310	50	110	61	1,64
310-29	1-13/16			1,98
310-30	1-7/8	4.3307	2.4016	1,73
310-31	1-15/16			1,67
UC311	55	120	66	2,07
311-32	2			2,25
311-33	2-1/16	4.7244	2.5984	2,18
311-34	2-1/8			2,12
311-35	2-5/16			2,04
UC312	60	130	71	2,60
312-36	2-1/4			2,75
312-37	2-5/15			2,67
312-38	2-3/8	5.1181	2.7952	2,58
312-39	2-7/16			2,50

Part number	Dimensions (mm/in.)			Weight Kg
	d	D	B	
UC313	65	140	75	3,17
313-40	2-1/2			3,26
313-41	2-9/16	5.5118	2.9527	3,16
UC314	70	150	78	3,79
314-42	2-3/8			4,01
314-43	2-11/16	5.9055	3.0709	3,90
314-44	2-3/4			3,80
UC315	75	160	82	4,52
315-45	2-13/16			4,79
315-46	2-7/8	6.2992	3.2283	4,65
315-47	2-15/16			4,56
315-48	3			4,43
UC316	80	170	86	5,32
316-49	3-1/16			5,49
316-50	3-1/8	6.6929	3.3858	5,35
316-51	3-3/16			5,26
UC317	85	180	96	6,48
317-52	3-1/4			6,70
317-53	3-5/16	7.0866	3.7795	6,67
317-55	3-7/16			6,45
UC318	90	190	96	7,33
318-55	3-7/16	7.4803	3.7795	7,62
318-56	3-1/2			7,44
UC319	95	200	103	8,81
319-58	3-5/8			9,14
319-59	3-11/16	7.8740	4.0551	8,96
319-60	3-3/4			8,77
UC320	100	215	108	10,71
320-64	4	8.4646	4.2520	10,51
UC322	110	240	117	14,55
		9.4488	4.6063	
UC324	120	260	126	18,47
		10.2362	4.9606	
UC326	130	280	135	22,98
		11.0236	5.3150	

Part number	Dimensions (mm/in.)			Weight Kg
	d	D	B	
UC328	140	300	145	27,98
		11.8110	5.7087	

Mounted Ball Bearing

DATA TABLE - UK2

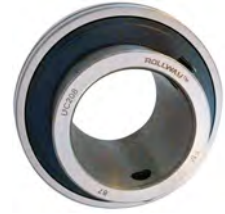
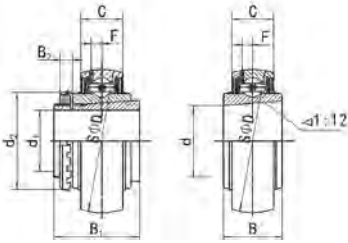

Part number	Dimensions (mm/in.)									Dynamic size mm/in.	Static load N mm/in.	Weight Kg
	d ₁	d	D	B	C	B ₁	B ₂	d ₂	F			
UK205 ; H2305	20	25	52	23	17	35	8	38	4,3	14000	7850	0,24
205 ; HE2305	3/4	0.9843	2.0472	0.9055	0.6693	1.378	0.315	1.496	0.169			
UK206 ; H2306	25	30	62	26	19	38	8	45	5,2	19450	11250	0,36
206 ; HE2306	1	1.1811	2.4409	1.0236	0.7480	1.496	0.315	1.772	0.204			
206 ; HS2306	7/8											
UK207 ; H2307	30	35	72	29	20	43	9	52	5,7	25700	15200	0,52
207 ; HS2307	1-1/8	1.3780	2.8346	1.1417	0.7874	1.693	0.354	2.047	0.224			
UK208 ; H2308	35	40	80	31	21	46	10	58	6,2	29500	18100	0,67
208 ; HE2308	1-1/4	1.5748	3.1496	1.2205	0.8268	1.811	0.394	2.283	0.244			
208 ; HS2308	1-3/8											
UK209 ; H2309	40	45	85	31	22	50	11	65	6,6	32700	20900	0,77
209 ; HA2309	1-7/16	1.7717	3.3465	1.2205	0.8661	1.969	0.433	2.559	0.260			
209 ; HE2309	1-1/2											
209 ; HS2309	1-5/8											
UK210 ; H2310	45	50	90	32	24	55	12	70	6,5	35000	23200	0,92
210 ; HA2310	1-3/4	1.9685	3.5433	1.2598	0.9449	2.165	0.472	2.756	0.256			
210 ; HE2310	1-11/16											
210 ; HS2310	1-5/8											
UK211 ; H2311	50	55	100	35	25	59	12	75	7,1	43300	29200	1,15
211 ; HA2311	1-15/16	2.1654	3.937	1.378	0.9843	2.323	0.472	2.953	0.28			
211 ; HE2311	2											
211 ; HS2311	1-7/8											
UK212 ; H2312	55	60	110	38	27	62	13	80	7,9	47700	32800	1,47
212 ; HS2312	2-1/8	2.3622	4.3307	1.4961	1.063	2.441	0.512	3.15	0.311			
UK213 ; H2313	60	65	120	40	28	65	14	85	8	57200	40000	1,81
213 ; HA2313	2-3/16	2.5591	4.7244	1.5748	1.1024	2.559	0.551	3.346	0.315			
213 ; HE2313	2-1/4											
213 ; HS2313	2-3/8											
UK215 ; H2315	65	75	130	44	30	73	15	98	8,6	66200	49300	2,55
215 ; HA2315	2-7/16	2.9528	5.1181	1.7323	1.1811	2.874	0.591	3.858	0.339			
215 ; HE2315	2-1/2											
UK216 ; H2316	70	80	140	45	32	78	17	105	9	72600	53300	3,08
216 ; HA2316	2-11/16	3.1496	5.5118	1.7717	1.2598	3.071	0.669	4.134	0.354			
216 ; HE2316	2-3/4											
UK217 ; H2317	75	85	150	46	34	82	18	110	9,8	83300	63700	3,70
217 ; HA2317	2-15/16	3.3465	5.9055	1.8110	1.3386	3.228	0.709	4.331	0.386			
217 ; HE2317	3											
UK218 ; H2318	80	90	160	47	36	86	18	120	10,8	96000	71100	4,34
218 ; HA2318	3-3/16	3.5433	6.2992	1.8504	1.4173	3.386	0.709	4.724	0.425			

Mounted Ball Bearing

DATA TABLE - UCX

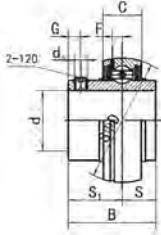

Seal options



Part number	Dimensions (mm/in.)									Dynamic size mm/in.	Static load N mm/in.	Weight Kg
	d	D	B	C	S	S ₁	G	d _s	F			
UCX05	25	62	38,1	19	15,9	22,2	5	M6x1	5	19450	11250	0,36
X05-13	13/16	2 4/9	1 1/2	3/4	5/8	7/8	1/5	1/4-28UNF	0.197			
X05-14	7/8											
X05-15	15/16											
X05-16	1											
UCX06	30	72	42,9	20	17,5	25,4	7	M8x1	5,7	25700	15200	0,53
X06-17	1-1/16	2 5/6	1 2/3	4/5	2/3	1	2/7	5/16-24UNF	0.224			
X06-18	1-1/8											
X06-19	1-3/16											
UCX07	35									80	49,2	21
X07-20	1-1/4	3 1/7	2	5/6	3/4	1 1/5	1/3	5/16-24UNF	0.244			
X07-21	1-5/16											
X07-22	1-3/8											
X07-23	1-7/16											
UCX08	40	85	49,2	22	19,0	30,2	8	M8x1	6,4	32700	20900	0,77
X08-24	1-1/2	3 1/3	2	6/7	3/4	1 1/5	1/3	5/16-24UNF	0.252			
X08-25	1-9/16											
UCX09	45	90	51,6	24	19,0	32,6	10	M10x1	6,5	35000	23200	0,88
X09-26	1-5/8	3 1/2	2	1	3/4	1 2/7	2/5	3/8-24UNF	0.256			
X09-27	1-11/16											
X09-28	1-3/4											
UCX10	50	100	55,6	25	22,2	33,4	10	M10x1	7,0	4300	29200	1,15
X10-30	1-7/8	4	2 1/5	1	7/8	1 1/3	2/5	3/8-24UNF	0.276			
X10-31	1-15/16											
UCX11	55	110	65,1	27	25,4	39,7	10	M10x1	7,6	47700	32800	1,55
X11-33	2-1/16	4 1/3	2 4/7	1	1	1 4/7	2/5	3/8-24UNF	0.299			
X11-34	2-1/8											
X11-35	2-5/16											
UCX12	60	120	65,1	28	25,4	39,7	10	M10x1	8,5	57200	40000	1,93
X12-38	2-3/8	4 5/7	2 4/7	1 1/9	1	1 4/7	2/5	3/8-24UNF	0.335			
X12-39	2-7/16											
UCX13	65	125	74,6	29	30,2	44,4	12	M12x1,5	8,9	62100	44800	2,08
X13-40	2-1/2	5	3	1 1/7	1 1/5	1 3/4	1/2	1/2-20UNF	0.350			
X13-41	2-9/16											

Mounted Ball Bearing

DATA TABLE - UCX



Part number	Dimensions (mm/in.)									Dynamic size	Static load N	Weight
	d	D	B	C	S	S ₁	G	d _s	F	mm/in.	mm/in.	Kg
UCX14	70	130	77,8	30	33,3	44,5	12	M12x1,5	9,2	66200	49300	2,44
X14-42	2-3/8	5 1/8	3	1 1/6	1 1/3	1 3/4	1/2	1/2-20UNF	0.362			
X14-43	2-11/16											
X14-44	2-3/4											
UCX15	75	140	82,6	32	33,3	49,3	12	M12x1,5	9,5	72600	53300	2,90
X15-45	2-13/16	5 1/2	3 1/4	1 1/4	1 1/3	2	1/2	1/2-20UNF	0.374			
X15-46	2-7/8											
X15-47	2-15/16											
X15-48	3											
UCX16	80	150	85,7	34	34,1	51,6	12	M12x1,5	10,2	83300	63700	3,90
X16-49	3-1/16	6	3 3/8	1 1/3	1 1/3	2	1/2	1/2-20UNF	0.402			
X16-50	3-1/8											
X16-51	3-3/16											
UCX17	85									160	96,0	36
X17-53	3-5/16	6 2/7	3 7/9	1 3/7	1 4/7	2 2/9	1/2	1/2-20UNF	0.441			
X17-55	3-7/16											
UCX18	90	170	104,0	39	42,9	61,1	16	M14x1,5	12,5	109000	82000	5,66
X18-56	3-1/2	6 2/3	4	1 1/2	1 2/3	2 2/5	5/8	9/16-18UNF	0.492			
UCX20	100	190	117,5	43	49,2	68,3	18	M16x1,5	13,7	133000	105000	8,56
X20-64	4	7 1/2	4 5/8	1 2/3	2	2 2/3	5/7	5/8-18UNF	0.539			

Mounted Ball Bearing

DATA TABLE - HCF2

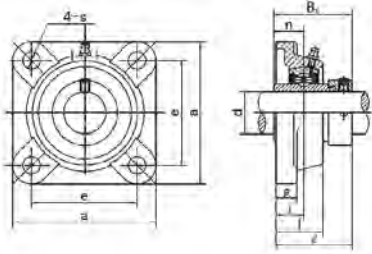

Part number	Dimensions (mm/in.)										Bolt size	Weight
	d	a	e	i	g	l	S	z	B ₁	n	mm/in.	Kg
HCF204	20	86	64	15	12	25,5	12	41,6	43,7	17,1	M10	0,60
204-12	3/4	3-3/8	2-33/64	19/32	15/32	1	15/32	1-41/64	1.720	0.673	3/8	0,60
HCF205	25	95	70	16	14	27	12	42,9	44,4	17,5	M10	0,79
205-13	13/16	3-3/4	2-3/4	5/8	35/64	1-1/16	15/32	1-11/16	1.748	0.689	3/8	0,84
205-14	7/8											0,83
205-15	15/16											0,81
205-16	1											0,79
HCF206	30	108	83	18	14	31	12	48,1	48,4	18,3	M10	1,10
206-17	1-1/16	4-1/4	3-17/64	45/64	35/64	1-7/32	15/32	1-57/64	1.906	0.720	3/8	1,15
206-18	1-1/8											1,12
206-19	1-3/16											1,10
206-20	1-1/4											1,07
HCF207	35											117
207-20	1-1/4	4-39/64	3-5/8	3/4	5/8	1-11/32	35/64	2-1/64	2.012	0.740	7/16	1,54
207-21	1-5/16											1,50
207-22	1-3/8											1,47
207-23	1-7/16											1,45
HCF208	40											130
208-24	1-1/2	5-1/8	4-1/64	53/64	5/8	1-27/64	5/8	2-13/64	2.217	0.843	1/2	1,85
208-25	1-9/16											1,81
HCF209	45	137	105	22	18	38	16	56,9	56,3	21,4	M14	2,13
209-26	1-5/8	5-13/32	4-9/64	55/64	23/32	1-1/2	5/8	2-15/64	2.217	0.843	1/2	2,24
209-27	1-11/16											2,19
209-28	1-3/4											2,15
HCF210	50											143
210-29	1-13/16	5-5/8	4-3/8	55/64	23/32	1-9/16	5/8	2-3/8	2.469	0.969	1/2	2,66
210-30	1-7/8											2,60
210-31	1-15/16											2,54
210-32	2											2,48
HCF211	55											162
211-32	2	6-3/8	5-1/8	63/64	25/32	1-11/16	3/4	2-45/64	2.811	1.094	5/8	3,69
211-33	2-1/16											3,51
211-34	2-1/8											3,44
211-35	2-3/16											3,36

Mounted Ball Bearing

DATA TABLE - HCF2



Part number	Dimensions (mm/in.)										Bolt size	Weight
	d	a	e	i	g	l	S	z	B ₁	n	mm/in.	Kg
HCF212	60	175	143	29	20	48	19	75,8	77,8	31	M16	4,27
212-36	2-1/4	6-57/64	5-5/8	1-9/64	25/32	1-57/64	3/4	2-63/64	3.063	1.22	5/8	4,28
212-37	2-5/16											4,34
212-38	2-3/8											4,27
212-39	2-7/16											4,26
HCF213	65	187	149	30	22	50	19	81,6	85,7	34,1	M16	5,35
213-40	2-1/2	7-23/64	5-55/64	1-3/16	55/64	1-31/32	3/4	3-7/32	3.374	1.343	5/8	5,45
213-41	2-9/16											5,34
HCF214	70	193	152	31	22	54	19	82,6	85,7	34,1	M16	5,84
214-42	2-5/8	7-19/32	5-63/64	1-7/32	55/64	2-1/8	3/4	3-1/4	3.374	1.343	5/8	5,78
214-43	2-11/16											5,97
214-44	2-3/4											5,85
HCF215	75	200	159	34	22	56	19	88,8	92,1	37,3	M16	6,43
215-45	2-13/16	7-7/8	6-17/64	1-11/32	55/64	2-7/32	3/4	3-1/2	3.626	1.426	5/8	6,73
215-46	2-7/8											6,60
215-47	2-15/16											6,47
215-48	3											6,33
HCF216	80	208	165	34	22	58	23	91,9	95,2	37,3	M20	7,59
216-49	3-1/16	8-3/16	6-1/2	1-11/32	55/64	2-9/32	29/32	3-5/8	3.748	1.469	3/4	7,79
216-50	3-1/8											7,65
216-51	3-3/16											7,50
HCF217	85	220	175	36	24	63	23	86,4	73,8	23,4	M20	8,52
217-52	3-1/4	8-21/32	6-57/64	1-27/64	15/16	2-15/32	29/32	3-13/32	2.906	0.921	3/4	8,71
217-53	3-5/16											8,59
217-55	3-7/16											8,34
HCF218	90	235	187	40	24	68	23	88,1	72,6	24,5	M20	9,95
218-56	3-1/2	9-1/4	7-23/64	1-37/64	15/16	2-11/16	29/32	3-15/32	3.7795	1.5630	3/4	10,04

Mounted Ball Bearing

DATA TABLE - HCFL2

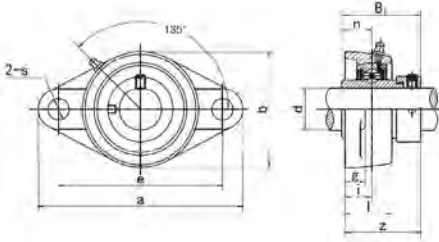

Part number	Dimensions (mm/in.)											Bolt size	Weight
	d	a	e	i	g	l	s	b	z	B ₁	n	mm/in.	Kg
HCFL204	20	113	90	15	11	25,5	12	60	41,6	43,7	17,1	M10	0,46
204-12	3/4	4-7/16	3-35/64	19/32	7/16	1	15/32	2-3/8	1-41/64	1.720	0.673	3/8	0,46
HCFL205	25	130	99	16	13	27	16	68	42,9	44,4	17,5	M14	0,63
205-13	13/16	5-1/8	3-57/64	5/8	1/2	1-1/16	5/8	2-11/16	1-11/16	1.748	0.689	1/2	0,68
205-14	7/8												0,67
205-15	15/16												0,65
205-16	1												0,63
HCFL206	30												148
206-17	1-1/16	5-13/16	4-39/64	45/64	1/2	1-7/32	5/8	3-5/32	1-57/64	1.906	0.720	1/2	0,95
206-18	1-1/8												0,92
206-19	1-3/16												0,90
206-20	1-1/4												0,87
HCFL207	35												161
207-20	1-1/4	6-11/32	5-1/8	3/4	35/64	1-11/32	5/8	3-35/64	2-1/64	2.012	0.740	1/2	1,31
207-21	1-5/16												1,27
207-22	1-3/8												1,24
207-23	1-7/16												1,22
HCFL208	40												175
208-24	1-1/2	6-7/8	5-43/64	53/64	35/64	1-13/32	5/8	3-15/16	2-13/64	2.217	0.843	1/2	1,60
208-25	1-9/16												1,56
HCFL209	45	188	148	22	15	38	19	108	56,9	56,3	21,4	M16	1,88
209-26	1-5/8	7-13/32	5-53/64	55/64	19/32	1-1/2	3/4	4-1/4	2-15/64	2.217	0.843	5/8	1,99
209-27	1-11/16												1,94
209-28	1-3/4												1,90
HCFL210	50												197
210-29	1-13/16	7-3/4	6-3/16	55/64	19/32	1-37/64	3/4	4-17/32	2-23/64	2.469	0.969	5/8	2,36
210-30	1-7/8												2,30
210-31	1-15/16												2,24
210-32	2												2,18
HCFL211	55												224
211-32	2	8-13/16	7-1/4	63/64	23/32	1-11/16	3/4	5-1/8	2-45/64	2.811	1.094	5/8	3,36
211-33	2-1/16												3,18
211-34	2-1/8												3,11
211-35	2-3/16												3,03

Mounted Ball Bearing

DATA TABLE - HCFL2



Part number	Dimensions (mm/in.)											Bolt size	Weight
	d	a	e	i	g	l	s	b	z	B ₁	n	mm/in.	Kg
HCFL212	60	250	202	29	18	48	23	140	75,8	77,8	31	M20	3,97
212-36	2-1/4	9-27/32	7-16/64	1-9/64	23/32	1-7/8	29/32	5-1/2	2-63/64	3.063	1.220	3/4	3,99
212-37	2-5/16												4,04
212-38	2-3/8												3,97
212-39	2-7/16												3,96
HCFL213	65	258	210	30	22	50	23	155	81,6	85,7	34,1	M20	5,10
213-40	2-1/2	10-5/32	8-17/64	1-3/16	7/8	1-31/32	29/32	6-3/32	3-7/32	3.374	1.343	3/4	5,20
213-41	2-9/16												5,09
HCFL214	70	265	216	31	22	54	23	160	82,6	85,7	34,1	M20	5,53
214-42	2-5/8	10-7/16	8-1/2	1-7/32	7/8	2-1/8	29/32	6-5/16	3-1/4	3.374	1.343	3/4	5,47
214-43	2-11/16												5,66
214-44	2-3/4												5,54
HCFL215	75	275	225	34	22	56	23	165	88,8	92,1	37,3	M20	6,09
215-45	2-13/16	10-13/16	8-55/64	1-11/32	7/8	2-7/32	29/32	6-1/2	3-1/2	3.626	1.469	3/4	6,39
215-46	2-7/8												6,26
215-47	2-15/16												6,13
215-48	3												5,99
HCFL216	80	290	233	34	22	58	25	180	91,9	95,2	37,3	M22	7,59
216-49	3-1/16	11-13/32	9-11/64	1-11/32	7/8	2-9/32	63/64	7-3/32	3-5/8	3.748	1.469	7/8	7,79
216-50	3-1/8												7,65
216-51	3-3/16	10-1/4	8-1/32	1-47/64	1-7/32	3-15/16	1-1/16	7-3/32	3-5/8	3.748	1.469	7/8	7,50
HCFL217	85	305	248	36	24	63	25	190	86,4	73,8	23,4	M22	8,52
217-52	3-1/4	9-27/32	5-51/64	23/32	1-25/32	70866	29/32	7-15/32	3-13/32	2.906	0.921	7/8	8,71
217-53	3-5/16												8,59
217-55	3-7/16	10-1/4	8-1/32	1-47/64	1-7/32	3-15/16	1-1/16	7-15/32	3-13/32	2.906	0.921	7/8	8,34
HCFL218	90	320	265	40	24	68	25	205	88,1	72,6	24,5	M22	9,95
218-56	3-1/2	12-19/32	10-7/16	1-37/64	15/16	2-11/16	63/64	8-1/16	8-15/32	3.7795	1.5630	7/8	10,04

Mounted Ball Bearing

DATA TABLE - HCP2

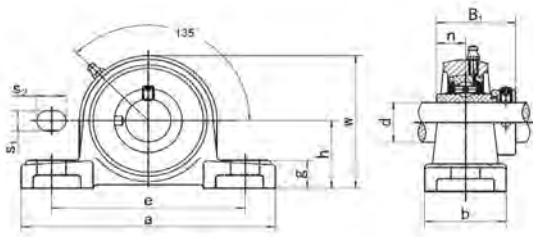

Part number	Dimensions (mm/in.)											Bolt size	Weight
	d	h	a	e	b	s ₁	s ₂	g	w	B1	n	mm/in.	Kg
HCP204	20	33,3	127	95	38	13	19	14	65	43,7	17,1	M10	0,70
204-12	3/4	1 1/3	5	3 3/4	1 1/2	1/2	3/4	5/9	2 5/9	1.7205	0.6732	3/8	0,70
HCP205	25	36,5	140	105	38	13	19	15	71	44,4	17,5	M10	0,81
205-13	13/16	1 3/7	5 1/2	4 1/7	1 1/2	1/2	3/4	3/5	2 4/5	1.7480	0.6890	3/8	0,86
205-14	7/8												0,85
205-15	15/16												0,83
205-16	1												0,81
HCP206	30	42,9	160	121	44	17	20	17	84	48,4	18,3	M14	1,27
206-17	1-1/16	1 2/3	6 2/7	4 3/4	1 3/4	2/3	4/5	2/3	3 1/3	1.9055	0.7205	1/2	1,32
206-18	1-1/8												1,29
206-19	1-3/16												1,27
206-20	1-1/4												1,24
HCP207	35												47,6
207-20	1-1/4	1 7/8	6 4/7	5	1 8/9	2/3	4/5	5/7	3 2/3	2.0118	0.7402	1/2	1,67
207-21	1-5/16												1,63
207-22	1-3/8												1,60
207-23	1-7/16												1,58
HCP208	40	49,2	184	137	54	17	20	18	100	56,3	21,4	M14	1,99
208-24	1-1/2	2	7 1/4	5 2/5	2 1/8	2/3	4/5	5/7	4	2.2165	0.8425	3/8	2,04
208-25	1-9/16												2,00
HCP209	45	54	190	146	54	17	20	20	106	56,3	21,4	M14	2,19
209-26	1-5/8	2 1/8	7 1/2	5 3/4	2 1/8	2/3	4/5	4/5	4 1/6	2.2165	0.8425	3/8	2,30
209-27	1-11/16												2,25
209-28	1-3/4												2,21
HCP210	50												57,2
210-29	1-13/16	2 1/4	8 1/9	6 1/4	2 1/3	4/5	1	5/6	4 4/9	2.4685	0.9685	5/8	2,95
210-30	1-7/8												2,89
210-31	1-15/16												2,83
210-32	2												2,77
HCP211	55	63,5	219	171	60	20	23	23	125	71,4	27,8	M16	3,50
211-32	2	2 1/2	8 5/8	6 3/4	2 1/3	4/5	1	1	5	2.8110	1.0945	5/8	3,80
211-33	2-1/16												3,62
211-34	2-1/8												3,55
211-35	2-3/16												3,47

Mounted Ball Bearing

DATA TABLE - HCP2



Part number	Dimensions (mm/in.)											Bolt size mm/in.	Weight Kg
	d	h	a	e	b	s ₁	s ₂	g	w	B1	n		
HCP212	60	69,8	241	184	70	20	23	25	138	778	31	M16	4,76
212-36	2-1/4	2 3/4	9 1/2	7 1/4	2 3/4	4/5	1	1	5 3/7	3.0630	1.2205	5/8	4,78
212-37	2-5/16												4,83
212-38	2-3/8												4,76
212-39	2-7/16												4,75
HCP213	65	76,2	265	203	70	25	28	27	150	85,7	34,1	M20	5,89
213-40	2-1/2	3	10 3/7	8	2 3/4	1	1 1/9	1	6	3.3740	1.3425	3/4	6,00
213-41	2-9/16												5,88
HCP214	70	79,4	266	210	72	25	28	27	156	85,7	34,1	M20	6,27
214-42	2-5/8	3 1/8	10 1/2	8 1/4	2 5/6	1	1 1/9	1	6 1/7	3.3740	1.3425	3/4	6,21
214-43	2-11/16												6,40
214-44	2-3/4												6,28
HCP215	75	82,6	275	217	74	25	28	28	162	92,1	37,3	M20	6,93
215-45	2-13/16	3 1/4	10 5/6	8 1/2	3	1	1 1/9	1 1/9	6 3/8	3.6260	1.4685	3/4	7,23
215-46	2-7/8												7,10
215-47	2-15/16												6,97
215-48	3												6,83
HCP216	80	88,9	292	232	78	25	28	30	174	95,2	37,3	M20	8,54
216-49	3-1/16	3 1/2	11 1/2	9 1/7	3	1	1 1/9	1 1/6	6 6/7	3.7480	1.4685	3/4	8,74
216-50	3-1/8												8,60
216-51	3-3/16												8,45
HCP217	85	95,2	310	247	83	25	28	32	185	73,8	23,4	M20	9,81
217-52	3-1/4	3 3/4	12 1/5	9 5/7	3 1/4	1	1 1/9	1 1/4	7 2/7	2.9055	0.9213	3/4	10,00
217-53	3-5/16												9,88
217-55	3-7/16												9,63
HCP218	90	101,6	327	262	88	27	30	33	198	72,6	24,5	M22	11,41
218-56	3-1/2	4	12 7/8	10 1/3	3 1/2	1	1 1/6	1 2/7	7 4/5	2.8583	0.9646	7/8	11,50

Mounted Ball Bearing

DATA TABLE - HCFC2

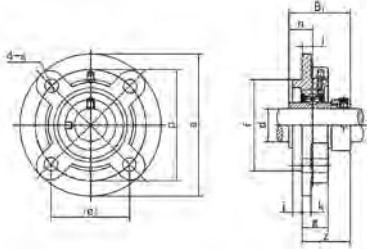

Part number	Dimensions (mm/in.)														Bolt size	Weight
	d	a	p	e	i	s	j	k	g	f	z	B ₁	n	mm/in.	Kg	
HCFC204	20	100	78	55,1	10	12	5	7	20,5	62	36,6	43,7	17,1	M10	0,72	
204-12	3/4	3-15/16	3-5/64	2-11/64	25/64	15/32	13/64	9/32	13/16	2.4409	1-7/16	1.720	0.673	3/8	0,72	
HCFC205	25	115	90	63,6	10	12	6	7	21	70	36,9	44,4	17,5	M10	0,94	
205-13	13/16	4-17/32	3-35/64	2-1/2	25/64	15/32	15/64	9/32	53/64	2.7559	1-29/64	1.748	0.689	3/8	0,99	
205-14	7/8														0,98	
205-15	15/16														0,96	
205-16	1														0,94	
HCFC206	30														125	100
206-17	1-1/16	4-59/64	3-15/16	2-25/32	25/64	15/32	5/16	5/16	29/32	3.1496	1-37/64	1.906	0.720	3/8	1,30	
206-18	1-1/8														1,27	
206-19	1-3/16														1,25	
206-20	1-1/4														1,22	
HCFC207	35														135	110
207-20	1-1/4	5-5/16	4-21/64	3-1/16	7/16	35/64	5/16	23/64	1-1/32	3.5433	1-45/64	2.012	0.740	7/16	1,74	
207-21	1-5/16														1,70	
207-22	1-3/8														1,67	
207-23	1-7/16														1,65	
HCFC208	40														145	120
208-24	1-1/2	5-45/64	4-23/32	3-11/32	7/16	35/64	25/64	23/64	1-1/32	3.9370	1-13/16	2.217	0.843	7/16	2,03	
208-25	1-9/16														1,99	
HCFC209	45	160	132	93,3	10	16	12	14	26	105	44,9	56,3	21,4	M14	2,66	
209-26	1-5/8	6-19/64	5-13/64	3-43/64	25/64	5/8	15/32	35/64	1-1/32	4.1339	1-49/64	2.217	0.843	1/2	2,77	
209-27	1-11/16														2,72	
209-28	1-3/4														2,68	
HCFC210	50														165	138
210-29	1-13/16	6-1/2	5-7/16	3-27/32	25/64	5/8	15/32	35/64	1-7/64	4.3307	1-57/64	2.469	0.969	1/2	3,12	
210-30	1-7/8														3,06	
210-31	1-15/16														3,00	
210-32	2														2,94	
HCFC211	55														185	150
211-32	2	7-9/32	5-29/32	4-3/16	33/64	3/4	15/32	19/32	1-7/32	4.9213	2-15/64	2.811	1.094	5/8	4,43	
211-33	2-1/16														4,25	
211-34	2-1/8														4,18	
211-35	2-3/16														4,10	

Mounted Ball Bearing

DATA TABLE - HCFC2



Part number	Dimensions (mm/in.)														Bolt size mm/in.	Weight Kg
	d	a	p	e	i	s	j	k	g	f	z	B ₁	n			
HCFC212	60	195	160	113,1	17	19	12	15	36	135	63,8	778	31,0	M16	5,01	
212-36	2-1/4														5,03	
212-37	2-5/16	7-11/16	6-19/64	4-29/64	43/64	3/4	15/32	19/32	1-27/64	5.3150	2-33/64	3.063	1.220	5/8	5,08	
212-38	2-3/8														5,01	
212-39	2-7/16														5,00	
HCFC213	65														205	170
213-40	2-1/2	8-5/64	6-11/16	4-47/64	5/8	3/4	35/64	19/32	1-27/64	5.708	2-21/32	3.374	1.343	5/8	5,94	
213-41	2-9/16														5,83	
HCFC214	70	215	177	125,1	17	19	14	18	40	150	68,6	85,7	34,1	M16	6,87	
214-42	2-5/8														6,81	
214-43	2-11/16	8-15/32	6-31/32	4-59/64	43/64	3/4	35/64	23/32	1-37/64	5.9055	2-45/64	3.374	1.343	5/8	7,00	
214-44	2-3/4														6,88	
HCFC215	75	220	184	130,1	18	19	16	18	40	160	72,8	92,1	37,3	M16	7,34	
215-45	2-13/16	8-21/32	7-1/4	5-1/8	23/32	3/4	5/8	23/32	1-37/64	6.2992	2-7/8	3.626	1.469	5/8	7,64	
215-46	2-7/8														7,51	
215-47	2-15/16														7,38	
215-48	3														7,24	
HCFC216	80	240	200	141,4	18	23	16	18	42	170	75,9	95,2	37,3	M20	9,15	
216-49	3-1/16	9-29/64	7-7/8	5-9/16	23/32	29/32	5/8	23/32	1-21/32	6.6929	2-63/64	3.748	1.469	3/4	9,35	
216-50	3-1/8														9,21	
216-51	3-3/16	10-1/4	8-1/32	1-47/64	1-1/16			2-29/32	1-7/32	3-15/16	3.7795				9,06	
HCFC217	85	250	208	147,1	18	23	18	20	45	180	68,4	73,8	23,4	M20	10,43	
217-52	3-1/4	9-27/32	8-3/16	5-51/64	23/32	29/32	23/32	25/32	1-25/32	7.0866	2-45/64	2.905	0.921	3/4	10,62	
217-53	3-5/16														10,50	
217-55	3-7/16	10-1/4	8-1/32	1-47/64	1-1/16			2-29/32	1-7/32	3-15/16	3.7795				10,25	
HCFC218	90	265	220	155,5	22	23	18	20	50	190	70,1	72,6	24,5	M20	12,06	
218-56	3-1/2	10-7/16	8-21/32	6-1/8	55/64	29/32	23/32	25/32	1-31/32	7.4803	2-3/4	2.858	0.964	3/4	12,15	

Mounted Ball Bearing

DATA TABLE - HCT2

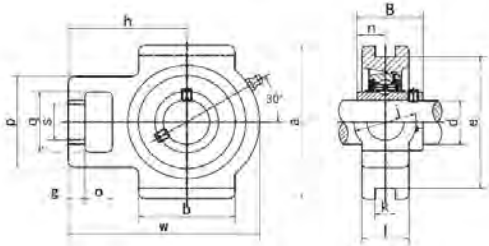

Part number	Dimensions (mm/in.)																Weight
	d	o	g	p	q	s	b	k	e	a	w	j	l	h	B'	n	Kg
HCT204	20	16	10	51	32	19	51	12	76	89	94	32	21	61	43,7	17,1	0,78
204-12	3/4	5/8	25/64	1-1/16	1-1/4	3/4	2-1/64	15/32	2-63/64	3-1/2	3-11/16	1-1/4	13/16	2-13/32	1.720	0.673	0,78
HCT205	25	16	10	51	32	19	51	12	76	89	97	32	24	62	44,4	17,5	0,86
205-13	13/16	5/8	25/64	1-1/64	1-1/4	3/4	2-1/64	15/32	2-63/64	3-1/2	3-13/16	1-1/4	15/16	2-7/16	1.748	0.689	0,91
205-14	7/8																0,90
205-15	15/16																0,88
205-16	1																0,86
HCT206	30	16	10	56	37	22	57	12	89	102	113	37	28	70	48,4	18,3	1,29
206-17	1-1/16	5/8	25/64	2-7/32	1-29/64	55/64	2-1/4	15/32	3-1/2	4-1/64	4-29/64	4-29/64	1-3/32	2-3/4	1.906	0.720	1,34
206-18	1-1/8																1,31
206-19	1-3/16																1,29
206-20	1-1/4																1,26
HCT207	35																16
207-20	1-1/4	5/8	33/64	2-33/64	1-29/64	55/64	2-33/64	15/32	3-1/2	4-1/64	5-5/64	1-29/64	1-3/16	3-5/64	20.12	0.740	1,77
207-21	1-5/16																1,73
207-22	1-3/8																1,70
207-23	1-7/16																1,68
HCT208	40																19
208-24	1-1/2	3/4	5/8	3-17/64	1-15/16	1-9/64	3-17/64	5/8	4-1/64	4-31/64	5-43/64	1-15/16	1-5/16	3-1/2	2.217	0.843	2,50
208-25	1-9/16																2,46
HCT209	45	19	16	83	49	29	83	16	102	117	144	49	35	87	56,3	21,4	2,47
209-26	1-5/8	3/4	5/8	3-17/64	1-15/16	1-9/64	3-17/64	5/8	4-1/64	4-39/64	5-43/64	1-15/16	1-3/8	3-27/64	2.217	0.843	2,58
209-27	1-11/16																2,53
209-28	1-3/4																2,49
HCT210	50	19	16	83	49	29	86	16	102	117	149	49	37	90	62,7	24,6	2,66
210-29	1-13/16	3/4	5/8	3-17/64	1-15/16	1-9/64	3-25/64	5/8	4-1/64	4-39/64	5-55/64	1-15/16	1-15/32	3-35/64	2.469	0.969	2,81
210-30	1-7/8																2,75
210-31	1-15/16																2,69
210-32	2																2,63
HCT211	55	25	19	102	64	35	95	22	130	146	171	64	38	106	71,4	27,8	4,01
211-32	2	63/64	3/4	4-1/64	2-33/64	1-3/8	3-3/4	55/64	5-1/8	5-3/4	6-47/64	2-33/64	1-1/2	4-11/64	2.811	1.094	4,31
211-33	2-1/16																4,13
211-34	2-1/8																4,06
211-35	2-3/16																3,98

Mounted Ball Bearing

DATA TABLE - HCT2



Part number	Dimensions (mm/in.)																Weight
	d	o	g	p	q	s	b	k	e	a	w	j	l	h	B ¹	n	Kg
HCT212	60	32	19	102	64	35	102	22	130	146	194	64	42	119	77,8	31	4,90
212-36	2-1/4																4,92
212-37	2-5/16	1-17/64	3/4	4-1/64	2-33/64	1-3/8	4-1/64	55/64	5-1/8	5-3/4	7-41/64	2-33/64	1-21/32	4-11/16	3.063	1.220	4,97
212-38	2-3/8																4,90
212-39	2-7/16																4,89
HCT213	65																32
213-40	2-1/2	1-17/64	53/64	4-3/8	2-3/4	1-39/64	4-49/64	1-1/32	5-15/16	6-37/64	8-13/16	2-3/4	1-47/64	5-25/64	3.374	1.343	7,24
213-41	2-9/16																7,13
HCT214	70	32	21	111	70	41	121	26	151	167	224	70	46	137	85,7	34,1	7,15
214-42	2-5/8																7,09
214-43	2-11/16	1-17/64	53/64	4-3/8	2-3/4	1-39/64	4-49/64	1-1/32	5-15/16	6-37/64	8-13/16	2-3/4	1-13/16	5-25/64	3.374	1.343	7,28
214-44	2-3/4																7,16
HCT215	75	32	21	111	70	41	121	26	151	167	232	70	48	140	92,1	37,3	7,67
215-45	2-13/16																7,97
215-46	2-7/8	1-17/64	53/64	4-3/8	2-3/4	1-39/64	4-49/64	1-1/32	5-15/16	6-37/64	9-9/64	2-3/4	1-57/64	5-33/64	3.626	1.426	7,84
215-47	2-15/16																7,71
215-48	3																7,57
HCT216	80	32	21	111	70	41	121	26	165	184	235	70	51	140	95,2	37,3	8,76
216-49	3-1/16																8,96
216-50	3-1/8	1-17/64	53/64	4-3/8	2-3/4	1-39/64	4-49/64	1-1/32	6-1/2	7-1/4	9-1/4	2-3/4	2	5-33/64	3.748	1.469	8,82
216-51	3-3/16																8,67
HCT217	85	38	29	124	73	48	157	30	173	198	260	73	54	162	73,8	23,4	10,91
217-52	3-1/4																11,10
217-53	3-5/16	1-1/2	1-9/64	4-7/8	2-7/8	1-57/64	6-3/16	1-3/16	6-13/16	7-51/64	10-15/64	2-7/8	2-1/8	6-3/8	2.906	0.921	10,98
217-55	3-7/16																10,73
HCT218	90	40	30	130	80	48	140	30	190	215	275	80	55	170	72,6	24,5	12,01
218-56	3-1/2	1-37/64	1-3/16	5-1/8	3-5/32	1-57/64	5-35/64	1-3/16	7-31/64	8-15/32	10-53/64	3-5/32	2-11/64	6-11/16	3.7795	1.5630	12,10

Mounted Ball Bearing

DATA TABLE - HC2

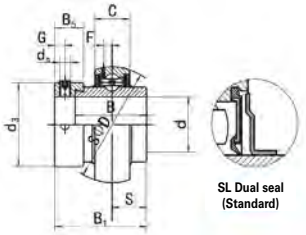

Part number	Dimensions (mm/in.)											Dynamic size	Static load N	Weight
	d	D	B ₁	B	C	S	d _s	G	B _s	d ₃	F	mm/in.	mm/in.	Kg
HC201	12	47	43,7	34,2	17	17,1	M6x1	4,8	13,5	33,3	3,4	12800	6600	0,29
201-8	1/2	1.8504	1.720	1.3465	0.6693	0.673	1/4-28UNF	0.189	0.531	1.311	0.134			0,29
HC202	15	1.8504	1.720	1.3465	0.6693	0.673	1/4-28UNF	0.189	0.531	1.311	0.134	12800	6600	0,27
202-9	9/16													0,26
202-10	5/8													0,26
HC203	17	1.8504	1.720	1.3465	0.6693	0.673	1/4-28UNF	0.189	0.531	1.311	0.134	12800	6600	0,25
203-11	11/16													0,25
HC204	20	47	43,7	34,2	17	17,1	M6x1	4,8	13,5	33,3	3,4	12800	6600	0,21
204-12	3/4	1.8504	1.720	1.3465	0.6693	0.673	1/4-28UNF	0.189	0.531	1.311	0.134			0,21
HC205	25	52	44,4	34,9	17	17,5	M6x1	4,8	13,5	38,1	4,3	14000	7850	0,25
205-13	13/16	2.0472	1.748	1.3740	0.6693	0.689	1/4-28UNF	0.189	0.531	1.500	0.160			0,30
205-14	7/8													0,29
205-15	15/16													0,27
205-16	1													0,25
HC206	30											62	48,4	36,5
206-17	1-1/16	2.4409	1.906	1.4370	0.7480	0.720	5/16-24UNF	0.236	0.626	1.752	0.205	0,42		
206-18	1-1/8											0,39		
206-19	1-3/16											0,37		
206-20	1-1/4											0,34		
HC207	35											72	51,1	37,6
207-20	1-1/4	2.8346	2.012	1.4803	0.7874	0.740	5/16-24UNF	0.268	0.689	2.189	0.224	0,65		
207-21	1-5/16											0,61		
207-22	1-3/8											0,58		
207-23	1-7/16											0,56		
HC208	40											80	56,3	42,8
208-24	1-1/2	3.1496	2.217	1.6850	0.8268	0.843	5/16-24UNF	0.268	0.720	2.374	0.244	0,78		
208-25	1-9/16											0,74		
HC209	45											85	56,3	42,8
209-26	1-5/8	3.3465	2.217	1.6850	0.8661	0.843	5/16-24UNF	0.268	0.720	2.5000	0.260	0,89		
209-27	1-11/16											0,84		
209-28	1-3/4											0,80		
HC210	50											90	62,7	49,2
210-29	1-13/16	3.5433	2.469	1.9370	0.9449	0.969	5/16-24UNF	0.268	0.720	2.752	0.256	1,09		
210-30	1-7/8											1,03		
210-31	1-15/16											0,97		
210-32	2											0,91		

Mounted Ball Bearing

DATA TABLE - HC2



Part number	Dimensions (mm/in.)											Dynamic size mm/in.	Static load N mm/in.	Weight Kg		
	d	D	B ₁	B	C	S	d _s	G	B ₅	d ₃	F					
HC211	55	100	71,4	55,5	25	278	M10x1	8	20,7	76,2	7,1	43300	29200	1,26		
211-32	2	3.9370	2.811	2.1850	0.9843	1.094	3/8-24UNF	0.315	0.815	3.000	0.280			43300	29200	1,46
211-33	2-1/16															1,38
211-34	2-1/8															1,31
211-35	2-3/16															1,23
HC212	60	110	77,8	61,9	27	31	M10x1	8	22,3	84,2	7,9	47700	32800	1,71		
212-36	2-1/4	4.3307	3.063	2.4370	1.0630	1.220	3/8-24UNF	0.315	0.878	3.315	0.311			47700	32800	1,73
212-37	2-5/16															1,78
212-38	2-3/8															1,71
212-39	2-7/16															1,71
HC213	65	120	85,7	68,6	28	34,1	M10x1	8,5	23,5	92	8,0	57200	40000	2,24		
213-40	2-1/2	4.7244	3.374	2.7008	1.1024	1.343	3/8-24UNF	0.335	0.925	3.622	0.315			57200	40000	1,80
213-41	2-9/16															2,23
HC214	70	125	85,7	68,6	29	34,1	M10x1	8,5	23,5	97	8,3	62100	44800	2,35		
214-42	2-5/8	4.9213	3.374	2.7008	1.1417	1.343	3/8-24UNF	0.335	0.925	3.819	0.327			62100	44800	2,29
214-43	2-11/16															2,48
214-44	2-3/4															2,36
HC215	75											130	92,1			75
215-45	2-13/16	5.1181	3.626	2.9528	1.1811	1.469	3/8-24UNF	0.335	0.925	4.016	0.339	66200	49300	2,94		
215-46	2-7/8													2,81		
215-47	2-15/16													2,54		
215-48	3													2,50		
HC216	80	140	95,2	74,6	32	37,3	M12x1,5	10,5	27	110	9,0	72600	53300	3,33		
216-49	3-1/16	5.5118	3.748	2.937	1.2598	1.4685	1/2-20UNF	0.4133	1.063	4.3307	0.354			72600	53300	3,53
216-50	3-1/8															3,39
216-51	3-3/16															3,24
HC217	85											150	73,8			53,2
217-52	3-1/4	5.9055	2.9055	2.0945	1.3386	0.9213	1/2-20UNF	0.4133	1.063	4.6850	0.386	83300	63700	3,73		
217-53	3-5/16													3,61		
217-55	3-7/16													3,36		
HC218	90													160	72,6	55
218-56	3-1/2	6.2992	2.8583	2.1654	1.4173	0.9645	1/2-20UNF	0.3543	0.9449	4.8031	0.425	96000	71100	3,95		

TECHNICAL NOTEBOOK

ROLLWAY®

PLUMMER BLOCKS



In this section:

	Page
Design Characteristics Applications	258
Nomenclature	259
Radial clearance Housing Designs	260
Seal designs	261
Data Tables	262-287

REGAL®

Plummer Blocks

DESIGN | CHARACTERISTICS | APPLICATIONS

- Suitable for OEM and replacement applications.
- Reduce down time for machinery during bearing replacement.
- Housings are made for shaft diameter from 25mm to 220mm.
- Optionally housings can be ordered with 2 or 4 bolts.
- Plummer blocks are suitable for Self-Aligning Ball & Spherical Roller Bearings. Suites with Rollway® GMEX bearings and other brand's.
- Basic hollow housing are made of cast iron. Other materials are optional.
- Available for cylindrical or tapered bore. The Rollway sleeves match perfectly in the housings.
- Large range of appropriated seals and covers for harsh operating condition.
- For a housing order, all components needs to be documented separately: Housing-, spacer ring-, seals-, bearing- and sleeve number.
- Different seal materials and designs are optional. See table on next page.

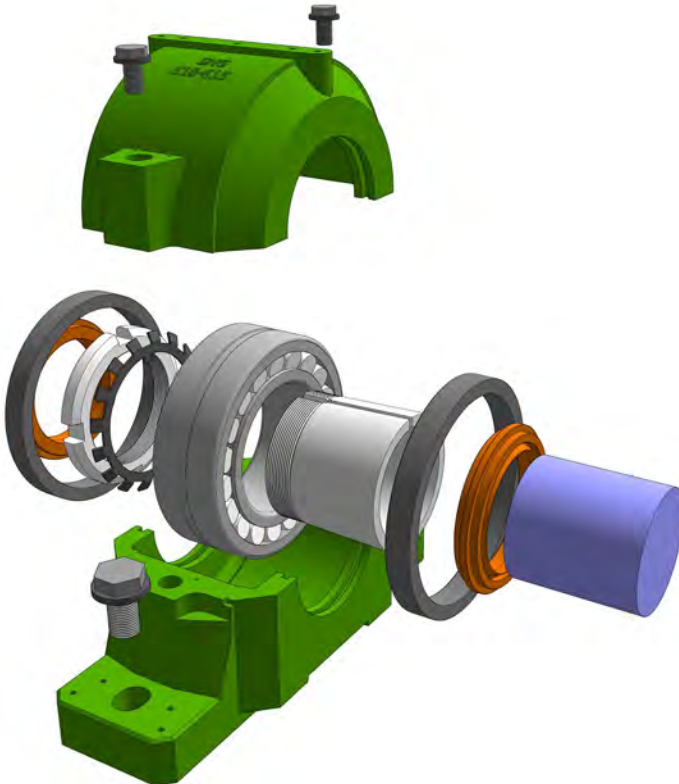

NOMENCLATURE

Rollway housings are fully interchangeable with the major brands. Each housing type is suitable for typical bearing series, sleeves and seals.

Housing	Self Aligning ball bearing		Spherical roller bearing		Sleeves	Remark	
SN 500	1205 K - 1219 K	2205 K - 2222 K	22205 K - 22232 K	23220 K - 23232 K	H(HE) 205 - 222 H(HE) 305-322 H(HE) 2306-2332 H(HE) 3124-3132	Upgraded by SNG	
SN 600	1305 K - 1322 K	2305 K - 2322 K	21308 K - 21317 K	22308 K - 22332 K	H(HE)305-322 H(HE)2318-2332		
SN 200	1205 - 1222	2205 - 2222	22205 - 22232	23218 - 23232			
SN 300	1305 - 1322	2305 - 2322	21308 - 21322	22308 - 2332			
SNU 500	1205 K - 1222 K		22207 K - 22232 K	23218 K - 23232 K	H207-222 H307-322 H2318-2332 H3124-3132	Upgraded by SNG	
SNG 500	1207 K - 1222 K		22207 K - 22232 K	23218 K - 23232 K	H207-222 H307-322 H2306-2332 H3124-3132	Newest design	
S 3000 K			23024 K - 23056 K		H 3024 - H 3056		
SD 3000			23034 K - 23076 K		H 3034 - H 3076		
SD 3100			23134 K - 23180 K		H 3134 - H 3180 HE 3134 - HE 3140		
CSD 3100			23168 K - 23196 K		H 3168 - H 3196		
SD 500			22234 K - 22264 K		H 3134 - H 3164		
SD 600			22334 K - 22356 K		H 2334 - H 2356		
SN 3000			23024 K - 23038 K		H 3024 - H 3038		
SN 3100			23122 K - 23132 K		H 3122 - H 3132		
SAF 500		1205 K - 1222 K	2205 K - 2222 K		22209 K - 22244 K	HA 205 - HA 222 HA 305 - HA 322 HA 3124 - HA 3144	
SAF 600		1309 K - 1322 K	2309 K - 2320 K		21309 K - 21322 K	22309 K - 22340 K	HA 309 - HA 322 HA 2333 - HA 2340 HA 3124 - HA 3132

Plummer Blocks

Radial clearance is standard in CN class. Radial class C3 is optional.
 Seal availability to the housing design

Seals	SN 500	SSN 500	SN 600	SSN 600	SN 200	SN 300	SN 3000	SN 3100	SNU 500	SNG 500	S 3000 K	SD 3000	SD 3100	CSD 3100	SD 500	SD 600	SAF 500	FSAF 500	SAF 600	FSAF 600	SNL500	
Felt	x	x	x	x	x	x	x	x			x				x	x						
TS												x		x			x		x			
TSNG									x	x												x
TSU									x	x												
TSA												x		x								
TAC TACONITE	x								x	x			x	x	x							
TST TACONITE	x								x	x												x
U-LOCK									x	x												x
TA																						
ASNA									x	x												x

HOUSING DESIGNS

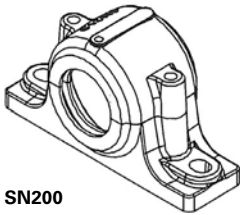

SN200

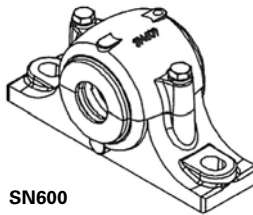

SN600

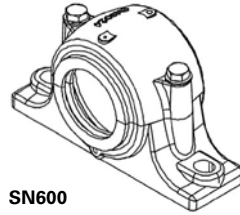

SN600

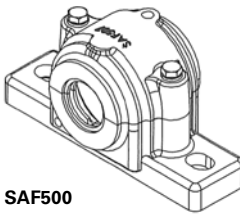

SAF500

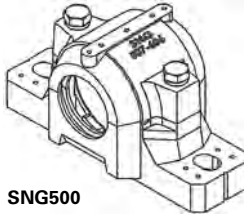

SNG500



SNU500

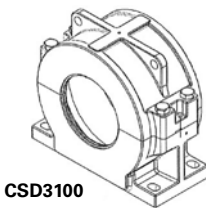

CSD3100

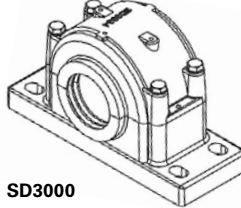

SD3000

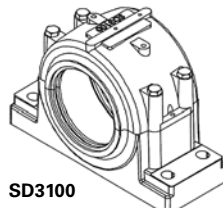

SD3100

SN, SNG, SNU, SNL are all interchangeable
 SAF are inch size Plummer blocks series

SEAL DESIGNS



SN 200/300
SN 500/600
SN 3000/3100
S 3000 K



SNU 500
SNG 500
SNL 500



SNU500
SNG500
SNL500



SNU 500
SNG 500
SNL 500



SN 500
SNU 500
SNG 500
SNL 500



SNU 500
SNG 500
SNL 500

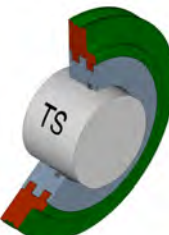

SD 3100 TS
CSD 3100 TAC

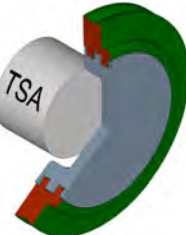

SD 3100 TS
CSD 3100 TAC

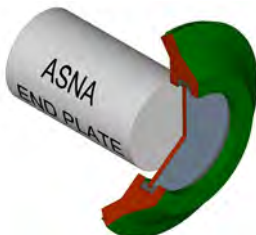

SNU 500
SNG 500
SNL 500



SNU 500
SNG 500
SNL 500

Plummer Blocks

DATA TABLE - SN500 / SSN500 PLUMMER BLOCK

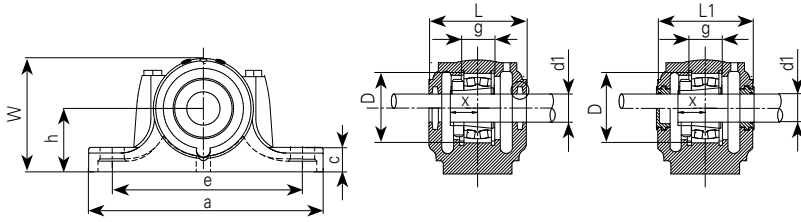

Part number	Shaft dia (mm)	Dimensions in mm											
		D H8	a	b	c	e	g H12	h H12	L	L1	W	n	u
SN505	20	52	165	46	22	130	25	40	67	70	75	25	15
SN506	25	62	185	52	22	150	30	50	77	80	90	25	15
SN507	30	72	185	52	22	150	33	50	82	85	95	25	15
SN508	35	80	205	60	25	170	33	60	85	90	110	30	115
SN509	40	85	205	60	25	170	31	60	85	90	112	30	15
SSN509													
SN510	45	90	205	60	25	170	33	60	90	95	115	30	15
SSN510													
SN511	50	100	255	70	28	210	33	70	95	100	130	35	18
SSN511													
SN512	55	110	255	70	30	210	38	70	105	110	135	35	18
SSN512													
SN513	60	120	275	80	30	230	43	80	110	115	150	40	18
SSN513													
SN515	65	130	280	80	30	230	41	80	115	120	155	40	18
SSN515													
SN516	70	140	315	90	32	260	43	95	120	125	175	50	22
SSN516													
SN517	75	150	320	90	32	260	46	95	125	130	185	50	22
SSN517													
SN518	80	160	345	100	35	290	62,4	100	145	150	195	50	22
SSN518													
SN519	85	170	345	100	35	290	53	112	140	145	210	50	22
SSN519													
SN520	90	180	380	110	40	320	70,3	112	160	165	218	60	26
SSN520													
SN522	100	200	410	120	45	350	80	125	175	180	240	70	26
SSN522													
SN524	110	215	410	120	45	350	86	140	185	190	270	70	26
SSN524													
SN526	115	230	445	130	50	380	90	150	190	195	290	70	26
SSN526													
SN528	125	250	500	150	50	420	98	150	205	210	305	80	33
SSN528													
SN530	135	270	530	160	60	450	106	160	220	225	325	90	33
SSN530													
SN532	140	290	550	160	60	470	114	170	235	240	345	90	33
SSN532													

Plummer Blocks

DATA TABLE - SN500 / SSSN500 PLUMMER BLOCK

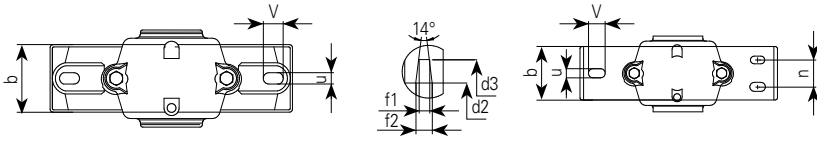

v	x	S2 S4	d2 H12	d3 H12	f1 H13	f2	Weight Kg	Bearing Nbr	Adapter Sleeve		Spacer		
											Nbr	Qty	
20	22	M12	21,5	31	3	4,2	1,22	1205K	22205K	H205	HE205	SR52x5	2
								2205K		H305	HE305	SR52x7	1
20	22	M12	26,5	38	4	5,4	1,74	1206K	22206K	H206	HE206	SR62X7	2
								2206K		H306	HE306	SR62X10	1
20	24	M12	31,5	43	4	5,4	1,96	1207K	22207K	H207	HE207	SR72X8	2
								2207K		H307	HE307	SR72X10	1
20	26	M12	36,5	48	4	5,4	2,75	1208K	22208K	H208	HE208	SR80X7,5	2
								2208K		H308	HE308	SR80X10	1
20	28	M12	41,5	53	4	5,4	2,65	1209K	22209K	H209	HE209	SR85X6	2
								3,8		2209K	H309	HE309	SR85X8
20	28	M12	46,5	58	4	5,4	2,6	1210K	22210K	H210	HE210	SR90X6,5	2
								3,77		2210K	H310	HE310	SR90X10
23	30	M16	51,5	67	5	6,9	4,27	1211K	22211K	H211	HE211	SR100X6	2
								6,27		2211K	H311	HE311	SR100X8
23	32	M16	56,5	72	5	6,9	4,37	1212K	22212K	H212	HE212	SR110X8	2
								6,03		2212K	H312	HE312	SR110X10
23	36	M16	62	77	5	6,8	6	1213K	22213K	H213	HE213	SR120X10	2
								8,46		2213K	H313	HE313	SR120X12
23	38	M16	67	82	5	6,8	6,5	1215K	22215K	H215	HE215	SR130X8	2
								9,13		2215K	H315	HE315	SR130X10
27	40	M20	72	89	6	8,1	8,5	1216K	22216K	H216	HE216	SR140X8,5	2
								12,1		2216K	H316	HE316	SR140X10
27	42	M20	77	94	6	8,1	10	1217K	22217K	H217	HE217	SR150X9	2
								13,4		2217K	H317	HE317	SR150X10
27	50	M20	82	99	6	8,1	12,6	1218K	22218K	H218	HE218	SR160X16,2	2
								16,37		2218K	H318	HE318	SR160X11,2
27	52	M20	87	104	6	8,1	13,2	1219K	22219K	H219	HE219	SR170X10,5	2
								17,9		2219K	H319	HE319	SR170X10
32	54	M24	92	111	7	9,3	17,2	2220K	22220K	H320	HE320	SR180X12,1	2
								23,2		23220K	H2320	HE2320	SR180X10
32	60	M24	102	125	8	10,8	21,5	2222K	22222K	H322	HE322	SR200X13,5	2
								29,1		23222K	H2322	HE2322	SR200X10
32	64	M24	113	135	8	10,7	24,5	22224K	22224K	H3124	HE3124	SR215X14	2
								33,3		23224K	H2324	HE2324	SR215X10
36	64	M24	118	140	8	10,7	31,5	22226K	22226K	H3126	HE3126	SR230X13	2
								41		23226K	H2326	HE2326	SR230X10
42	70	M30	128	154	9	12,2	40,2	22228K	22228K	H3128	HE3128	SR250X15	2
								51,1		23228K	H2328	HE2328	SR250X10
42	76	M30	138	164	9	12,2	45,3	22230K	22230K	H3130	HE3130	SR270X16,5	2
								59,9		23230K	H2330	HE2330	SR270X10
42	80	M30	143	173	10	13,7	49,5	22232K	22232K	H3132	HE3132	SR290X17	2
								65,7		23232K	H2332	HE2332	SR290X10

Plummer Blocks

DATA TABLE - SN600 / SSN600 PLUMMER BLOCK

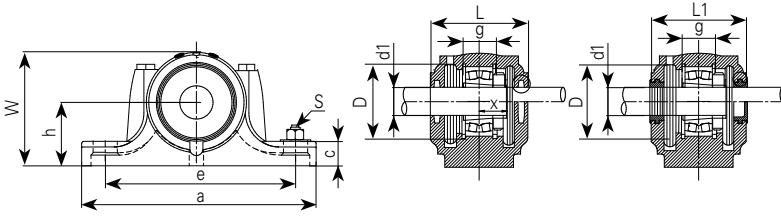

Part number	Shaft dia (mm)	Dimensions in mm											
		D H8	a	b	c	e	g H12	h H12	L	L1	W	n	u
SN605	20	62	185	52	22	150	34	50	80	83	90	25	15
SN606	25	72	185	52	22	150	37	50	82	85	95	25	15
SN607	30	80	205	60	25	170	41	60	90	93	110	30	15
SN608	35	90	205	60	25	170	43	60	95	100	115	30	15
SN609	40	100	255	70	28	210	46	70	105	110	130	35	18
SSN609													
SN610	45	110	255	70	30	210	50	70	115	120	135	35	18
SSN610													
SN611	50	120	275	80	30	230	53	80	120	125	150	40	18
SSN611													
SN612	55	130	280	80	30	230	56	80	125	130	155	40	18
SSN612													
SN613	60	140	315	90	32	260	58	95	130	135	175	50	22
SSN613													
SN615	65	160	345	100	35	290	65	100	140	145	195	50	22
SSN615													
SN616	70	170	345	100	35	290	68	112	145	150	212	50	22
SSN616													
SN617	75	180	380	110	40	320	70	112	155	160	218	60	26
SSN617													
SN618	80	190	400	110	33	320	74	112	160	165	230	60	26
SSN618													
SN619	85	200	420	120	36	350	77	125	170	175	245	70	26
SSN619													
SN620	90	215	420	120	38	350	83	140	175	180	280	70	26
SSN620													
SN622	100	240	460	130	40	390	90	150	190	195	300	70	28
SSN622													
SN624	110	260	540	160	50	450	96	160	205	210	325	90	33
SN626	115	280	560	160	50	470	103	170	215	220	350	90	33
SN628	125	300	630	170	55	520	112	180	235	240	375	90	35
SN630	135	320	680	180	55	560	118	190	245	250	395	90	35
SN632	140	340	710	180	60	580	124	200	255	260	415	100	42

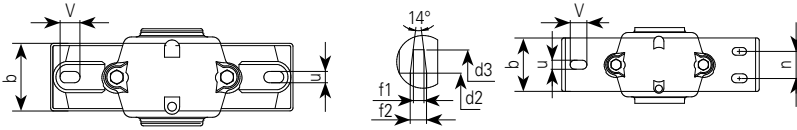

v	S2 S4	d2 H12	d3 H12	f1 H13	f2	Weight Kg	Bearing Nbr		Adapter Sleeve		Spacer	
											Nbr	Qty
20	M12	21,5	31	3	4,2	1,9	1305K		H305	HE305	SR62x8,5	2
							2305K		H2305	HE2305	SR62x10	1
20	M12	26,5	38	4	5,4	2,2	1306K		H306	HE306	SR72X9	2
							2306K		H2306	HE2306	SR72X10	1
20	M12	31,5	43	4	5,4	3	1307K		H307	H307	SR80X10	2
							2307K		H2307	H2307	SR80X10	1
20	M12	36,5	48	4	5,4	3,5	1308K	21308K	H308	HE308	SR90X10	2
							2308K	22308K	H2308	HE2308	SR90X10	1
23	M16	41,5	53	4	5,4	4,8	1309K	21309K	H309	H309	SR100X10,5	2
							6,5	2309K	22309K	H2309	HE2309	SR100X10
23	M16	46,5	58	4	5,4	5,6	1310K	21310K	H310	HE310	SR110X11,5	2
							7,2	2310K	22310K	H2310	HE2310	SR110X10
23	M16	51,5	67	5	6,9	6,5	1311K	21311K	H311	HE311	SR120X12	2
							8,9	2311K	22311K	H2311	HE2311	SR120X10
23	M16	56,5	72	5	6,9	8	1312K	21312K	H312	HE312	SR130X12,5	2
							9,4	2312K	22312K	H2312	HE2312	SR130X10
27	M20	62	77	5	6,8	9,1	1313K	21313K	H313	HE313	SR140X12,5	2
							12,4	2313K	22313K	H2313	HE2313	SR140X10
27	M20	67	82	5	6,8	12,9	1315K	21315K	H315	HE315	SR160X14	2
							16,8	2315K	22315K	H2315	HE2315	SR160X10
27	M20	72	89	6	8,1	14	1316K	21316K	H316	HE316	SR170X14,5	2
							18,8	2316K	22316K	H2316	HE2316	SR170X10
32	M24	77	94	6	8,1	16,3	1317K	21317K	H217	HE217	SR180X14,5	2
							22,2	2317K	22317K	H2317	HE2317	SR180X10
35	M24	82	99	6	8,1	22,4	1318K	22318K	H318	HE218	SR190X15,5	2
							28,1		2318K	H2318	HE318	SR190X10
35	M24	87	104	6	8,1	24,6	1319K	22319K	H319	HE219	SR200X16	2
							31,2		2319K	H2319	HE319	SR200X10
35	M24	92	111	7	9,3	28,8	1320K	23220K	H320	HE320	SR215X18	2
							37,5		2320K	H2320	HE2320	SR215X10
38	M24	102	125	8	10,8	36,5	1322K	23222K	H322	HE322	SR240X20	2
							46		2322K	H2322	HE2322	SR240X10
42	M30	113	135	8	10,7	49	64,8	23224K	H2324	HE2324	SR260X10	2
											57,5	1
42	M30	118	140	8	10,7	74,6	74,8	23226K	H2326	HE2326	SR280X10	2
											99,3	1
45	M30	128	154	9	12,2	99,3	83,5	23228K	H2328	HE2328	SR300X10	2
											111,6	1
45	M30	138	164	9	12,2	110	130	23230K	H2330	HE2330	SR320X10	2
											1	
52	M36	143	173	10	13,7	110	130	23232K	H2332	HE2332	SR340X10	2
											1	

Plummer Blocks

DATA TABLE - SN200 PLUMMER BLOCK

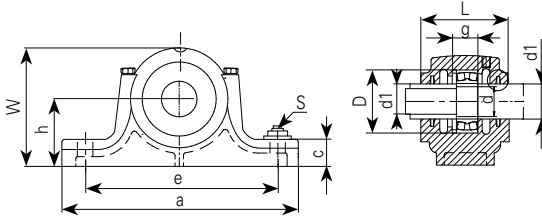

Part number	Shaft dia (mm)	Dimensions in mm											
		d1	D H8	a	b	c	e	g H12	h h12	L	W	u	v
SN205	25	30	52	165	46	22	130	25	40	67	75	15	20
SN206	30	35	62	185	52	22	150	30	50	77	90	15	20
SN207	35	45	72	185	52	22	150	33	50	82	95	15	20
SN208	40	50	80	205	60	25	170	33	60	85	110	15	20
SN209	45	55	85	205	60	25	170	31	60	85	112	15	20
SN210	50	60	90	205	60	25	170	33	60	90	115	15	20
SN211	55	65	100	255	70	28	210	33	70	95	130	18	23
SN212	60	70	110	255	70	30	210	38	70	105	135	18	23
SN213	65	75	120	275	80	30	230	43	80	110	150	18	23
SN214	70	80	125	275	80	30	230	43	80	110	150	18	23
SN215	75	85	130	280	80	30	230	41	80	115	155	18	23
SN216	80	90	140	315	90	32	260	43	95	120	175	22	27
SN217	85	95	150	320	90	32	260	46	95	125	185	22	27
SN218	90	100	160	345	100	35	290	62,4	100	145	195	22	27
SN219	95	110	170	345	100	35	290	53	112	140	210	22	27
SN220	100	115	180	380	110	40	320	70,3	112	160	218	26	32
SN222	110	125	200	410	120	45	350	80	125	175	240	26	32
SN224	120	135	215	410	120	45	350	86	140	185	270	26	32
SN226	130	145	230	445	130	50	380	90	150	190	290	26	36
SN228	140	155	250	500	150	50	420	98	150	205	305	33	42
SN230	150	165	270	530	160	60	450	106	160	220	325	33	42
SN232	160	175	290	550	160	60	470	114	170	235	345	33	42

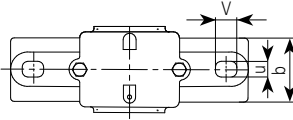
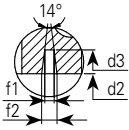

S2	d2 H12	d3 H12	f1 H13	f2	Weight Kg	Bearing Nbr		Spacer	
								Nbr	Qty
M12	31,5	43	4	5,4	1,22	1205	22205	SR52x5	2
						2205		SR52x7	1
M12	36,5	48	4	5,4	1,74	1206	22206	SR62X7	2
						2206		SR62X10	1
M12	46,5	58	4	5,4	1,96	1207	22207	SR72X8	2
						2207		SR72X10	1
M12	51,5	67	5	6,9	2,75	1208	22208	SR80X7,5	2
						2208		SR80X10	1
M12	56,5	72	5	6,9	2,65	1209	22209	SR85X6	2
						2209		SR85X8	1
M12	62	77	5	6,8	2,6	1210	22210	SR90X6,5	2
						2210		SR90X10	1
M16	67	82	5	6,8	4,27	1211	22211	SR100X6	2
						2211		SR100X8	1
M16	72	89	6	8,1	4,37	1212	22212	SR110X8	2
						2212		SR110X10	1
M16	77	94	6	8,1	6	1213	22213	SR120X10	2
						2213		SR120X12	1
M16	82	99	6	8,1	5,8	1213	22213	SR120X14	2
						2213		SR120X16	1
M16	87	104	6	8,1	6,5	1215	22215	SR130X8	2
						2215		SR130X10	1
M20	92	111	7	9,3	8,5	1216	22216	SR140X8,5	2
						2216		SR140X10	1
M20	97	116	7	9,3	10	1217	22217	SR150X9	2
						2217		SR150X10	1
M20	102	125	8	10,8	12,6	1218	22218	SR160X16,2	2
						2218		SR160X11,2	2
						23218		SR160X10	1
						1219		SR170X10,5	2
M20	113	135	8	10,7	13,2	2219	22219	SR170X10	1
						1220		SR180X12,1	2
M24	118	140	8	10,7	17,2	2220	23220	SR180X10	1
						1222		SR200X13,5	2
M24	128	154	9	12,2	21,5	23222	22222	SR200X10	1
						22224		SR215X14	2
M24	138	164	9	12,2	24,5	23224	22224	SR215X10	1
						22226		SR230X13	2
M24	148	178	10	13,7	31,5	23226	22226	SR230X10	1
						22228		SR250X15	2
M30	158	188	10	13,7	40,2	23228	22228	SR250X10	1
						22230		SR270X16,5	2
M30	168	198	10	13,7	45,3	23230	22230	SR270X10	1
						22232		SR290X17	2
M30	178	208	10	13,7	49,5	23232	22232	SR290X10	1

Plummer Blocks

DATA TABLE - SN300 PLUMMER BLOCK

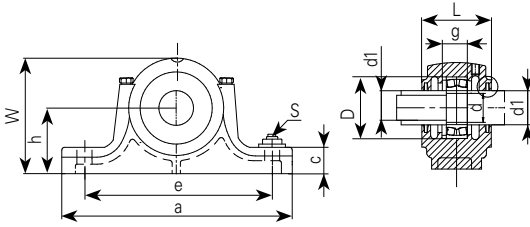

Part number	Shaft dia (mm)	Dimensions in mm											
		d1	D H8	a	b	c	e	g H12	h h12	L	W	u	v
SN305	25	30	62	185	52	22	150	34	50	80	90	15	20
SN306	30	35	72	185	52	22	150	37	50	82	95	15	20
SN307	35	45	80	205	60	25	170	41	60	90	110	15	20
SN308	40	50	90	205	60	25	170	43	60	95	115	15	20
SN309	45	55	100	255	70	28	210	46	70	105	130	18	23
SN310	50	60	110	255	70	30	210	50	70	115	135	18	23
SN311	55	65	120	275	80	30	230	53	80	120	150	18	23
SN312	60	70	130	280	80	30	230	56	80	125	155	18	23
SN313	65	75	140	315	90	32	260	58	95	130	175	22	27
SN314	70	80	150	320	90	32	260	61	95	130	185	22	27
SN315	75	85	170	345	100	35	290	65	100	140	195	22	27
SN316	80	90	180	345	100	35	290	68	112	145	212	22	27
SN317	85	95	150	380	110	40	320	70	112	155	218	26	32
SN318	90	100	160	400	110	33	320	74	112	160	230	26	35
SN319	95	110	170	420	120	36	350	77	125	170	245	26	35
SN320	100	115	180	420	120	38	350	83	140	175	280	26	35
SN322	110	125	200	460	130	40	390	90	150	190	300	26	38
SN324	120	135	215	540	160	50	450	96	160	205	325	33	42
SN326	130	145	230	560	160	50	470	103	170	215	350	33	42
SN328	140	155	250	630	170	55	520	112	180	235	375	35	45
SN330	150	165	270	680	180	55	560	118	190	245	395	35	45
SN332	160	175	290	710	190	60	580	124	200	255	415	42	52

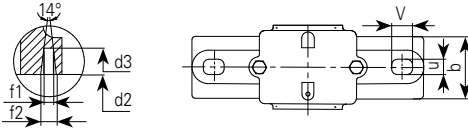

S2	d2 H12	d3 H12	f1 H13	f2	Weight Kg	Bearing Nbr		Spacer	
								Nbr	Qty
M12	31,5	43	4	5,4	1,92	1305		SR62X8,5	2
						2305		SR62X10	1
M12	36,5	48	4	5,4	2,04	1306		SR72X9	2
						2306		SR72X10	1
M12	46,5	58	4	5,4	2,96	1307		SR80X10	2
						2307		SR80X10	1
M12	51,5	67	5	56,9	3,22	1308	21308	SR90X10	2
						2308	22308	SR90X10	1
M16	56,5	72	5	6,9	4,73	1309	21309	SR100X10,5	2
						2309	22309	SR100X10	1
M16	62	77	5	6,8	5,34	1310	21310	SR110X11,5	2
						2310	22310	SR110X10	1
M16	67	82	5	6,8	6,32	1311	21311	SR120X12	2
						2311	22311	SR120X10	1
M16	72	89	6	8,1	6,93	1312	21312	SR130X12,5	2
						2312	22312	SR130X10	1
M20	77	94	6	8,1	8,63	1313	21313	SR140X12,5	2
						2313	22313	SR140X10	1
M20	82	99	6	8,1	10,41	1313	21314	SR150X13	2
						2313	22314	SR150X10	1
M20	87	104	6	8,1	12,74	1315	21315	SR160X14	2
						2315	22315	SR160X10	1
M20	92	111	7	9,3	14,62	1316	21316	SR170X14,5	2
						2316	22316	SR170X10	1
M24	97	116	7	9,3	18,41	1317	21317	SR180X14,5	2
						2317	22317	SR180X10	1
M24	102	125	8	10,8	21,3	1318	21318	SR190X15,5	2
						2318	22318	SR190X10	1
M24	113	135	8	10,7	25,2	1319	21319	SR200X16	2
						2319	22319	SR200X10	1
M24	118	140	8	10,7	27,1	1320	21320	SR215X18	2
						2320	22320	SR215X10	1
M24	128	154	99	12,2	37,25	1322	21322	SR240X20	2
						2322	22322	SR240X10	1
M30	138	164	10	12,2	49	21324		SR260X10	1
						22324			
M30	153	183	10	13,7	57,5	21326		SR280X10	1
						22326			
M30	163	193	10	13,7	74,8	21328		SR300X10	1
						22328			
M30	173	203	10	13,7	83,5	21330		SR320X10	1
						22330			
M36	183	213	10	13,7	110	21332		SR340X10	1
						22332			

Plummer Blocks

DATA TABLE - SNG500 PLUMMER BLOCK

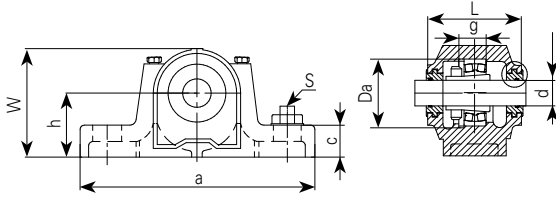

Part number	Shaft dia (mm)												
		D H8	a	b	c	e	g H12	h h12	L	W	u	v	n
SNG507 - 606	30	72	185	52	22	150	34	50	82	92	13	20	
SNG508 - 607	35	80	205	60	25	170	39	60	85	106	15	20	
SNG509	40	85	205	60	25	170	30	60	85	109	15	20	
SNG510 - 608	45	90	205	60	25	170	41	60	90	112	15	20	
SNG511 - 609	50	100	255	70	28	210	44	70	95	127	18	23	35
SNG512 - 610	55	110	255	70	30	210	48	70	105	133	18	23	35
SNG513 - 611	60	120	275	80	30	230	51	80	110	148	18	24	35
SNG515 - 612	65	130	280	80	30	230	56	80	115	154	18	26	40
SNG516 - 613	70	140	315	90	32	260	58	95	120	175	22	29	40
SNG517	75	150	320	90	32	260	61	95	125	181	22	30	50
SNG518 - 615	80	160	345	100	35	290	65	100	140	192	22	27	50
SNG519 - 616	85	170	345	100	35	290	68	112	145	209	22	27	50
SNG520 - 617	90	180	380	110	40	320	70	112	160	215	26	32	60
SNG522 - 619	100	200	410	120	45	350	80	125	175	239	26	32	70
SNG524 - 620	110	215	410	120	45	350	86	140	185	271	26	32	70
SNG526	115	230	445	130	50	380	90	150	190	290	28	35	70
SNG528	125	250	500	150	50	420	98	150	205	302	35	42	80
SNG530	135	270	530	160	60	450	106	160	220	323	35	42	90
SNG532	140	290	550	160	60	470	114	170	235	344	35	42	90

Plummer Blocks

DATA TABLE - SNG500 PLUMMER BLOCK

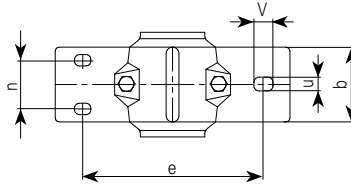
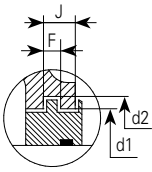

S2	S4	d1 H12	d2 H12	J	F	Weight Kg	Bearing Nbr	Adapter Sleeve	Spacer	
									Nbr	Qty
M10		46,5	54,5	7,5	5	2,4	1207K	H207	SR72X8,5	2
							22207K	H307	SR72X5,5	2
M12		51,5	59,5	7,5	5	3,2	1208K	H208	SR80X10,5	2
							22208K	H308	SR80X8	2
M12		56,5	64,5	8,5	5	3,5	1209K	H209	SR85X5,5	2
							22209K	H309	SR85X7	1
M12		62	70,5	8,5	5	3,85	1210K	H210	SR90X10,5	2
							22210K	H310	SR90X9	2
M16	M12	67	75,5	8,5	5	5,2	1211K	H211	SR100X11,5	2
							22211K	H311	SR100X9,5	2
M16	M12	72	80,5	8,5	5	6,7	1212K	H212	SR110X13	2
							22212K	H312	SR110X10	2
M16	M12	77	85,5	8,5	5	7,9	1213K	H213	SR120X14	2
							22213K	H313	SR120X10	2
M16	M12	87	95,5	8,5	5	7,7	1215K	H215	SR130X15,5	2
							22215K	H315	SR130X12,5	2
M20	M12	92,5	101	10,5	5	11	1216K	H216	SR140X16	2
							22216K	H316	SR140X12,5	2
M20	M12	97,5	106	10,5	5	12,7	1217K	H217	SR150X16,5	2
							22217K	H317	SR150X12,5	2
M20	M16	102,5	111	10,5	5	14,8	1218K	H218	SR160X17,5	2
							22218K	H318	SR160X12,5	2
M20	M16	131	141	11,5	6	15,5	23218K	H2318	SR160X12,5	1
							1219K	H219	SR170X18	2
M24	M16	137,5	147,5	11,5	6	18,4	22219K	H319	SR170X12,5	2
							1220K	H220	SR180X18	2
M24	M16	147,5	157,5	11,5	6	24,8	22220K	H320	SR180X12	2
							23220K	H2320	SR180X9,7	1
M24	M16	147,5	157,5	11,5	6	24,8	1222K	H222	SR200X21	2
							22222K	H322	SR200X13,5	2
M24	M16	157,5	167,5	11,5	6	32,2	23222K	H2322	SR200X10,2	1
							22224K	H224	SR215X14	2
M24	M20	167,5	177,5	13	6	39,8	23224K	H324	SR215X10	1
							22226K	H226	SR230X13	2
M30	M24	177,5	187,5	13	6	48,8	23226K	H326	SR230X10	1
							22228K	H228	SR250X15	2
M30	M24	192,5	202,5	13,5	6	56,5	23228K	H328	SR250X10	1
							22230K	H230	SR270X16,5	2
M30	M24	202,5	212,5	13,5	6	63,5	23230K	H330	SR270X10	1
							22232K	H232	SR290X17	2
							23232K	H332	SR290X10	1

Plummer Blocks

DATA TABLE - S3000K PLUMMER BLOCK

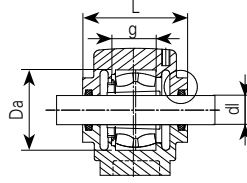
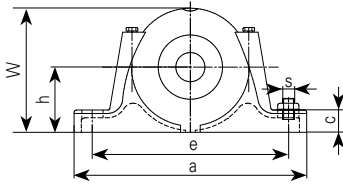

Part number	Shaft dia (mm)												
		D H8	a	b	c	e	g H12	h h12	L	W	u	v	s
S3024K	110	180	390	110	40	320	56	112	150	215	30	36	M24
S3026K	115	200	420	120	45	350	62	125	160	239	30	36	M24
S3028K	125	210	420	120	45	350	63	140	170	259	30	36	M24
S3030K	135	225	460	130	45	380	66	150	175	278	30	36	M24
S3032K	140	240	470	130	50	390	70	150	190	288	30	36	M24
S3034K	150	260	540	160	55	450	77	160	200	320	36	48	M30
S3036K	160	280	560	160	55	470	84	170	210	340	36	48	M30
S3038K	170	290	560	160	55	470	85	170	210	353	36	48	M30
S3040K	180	310	615	170	60	515	92	180	235	373	36	48	M30
S3044K	200	340	690	190	70	580	100	200	255	408	42	50	M36
S3048K	220	360	720	200	75	610	102	210	265	433	42	50	M36
S3052K	240	400	820	220	80	680	114	240	285	485	52	70	M45
S3056K	260	420	860	230	80	720	116	250	295	505	52	70	M45

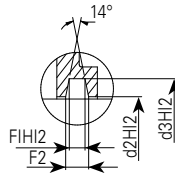
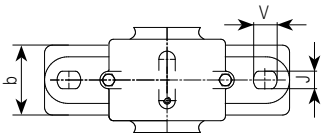

d2 H12	d3 H12	f1 H12	f2	Weight		Bearing Nbr	Adapter Sleeve	Spacer	
				Kg				Nbr	Qty
113	135	8	10,7	17,4		23024K	H3024	FR180/10	1
118	140	8	10,7	23,1		23026K	H3026	FR200/10	1
128	154	9	12,2	25,7		23028K	H3028	FR210/10	1
138	164	9	12,2	26,5		23030K	H3030	FR225/10	1
143	173	10	13,7	37,3		23032K	H3032	FR240/10	1
153	183	10	13,7	49,3		23034K	H3034	FR260/10	1
163	193	10	13,7	55,8		23036K	H3036	FR280/10	1
173	203	10	13,7	59,3		23038K	H3038	FR290/10	1
183	213	10	13,7	69,2		23040K	H3040	FR310/10	1
203	240	11	15,5	99,1		23044K	H3044	FR340/10	1
223	260	11	15,5	111,4		23048K	H3048	FR360/10	1
243	286	12	17,3	130		23052K	H3052	FR400/10	1
263	306	12	17,3	176		23056K	H3056	FR420/10	1

Plummer Blocks

DATA TABLE - SD3000 PLUMMER BLOCK

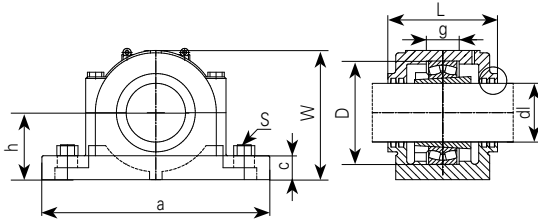

Part number	Shaft dia (mm)	D	a	b	c	e	g	h	L	W	n	u	v
		H8					H12	h12					
SD3034	150	260	540	200	50	450	77	160	230	320	110	36	52
SD3036	160	280	560	220	50	470	84	170	250	340	120	36	52
SD3038	170	290	560	220	50	470	85	170	250	345	120	36	52
SD3040	180	310	620	230	60	510	92	180	270	360	140	36	52
SD3044	200	340	700	260	65	570	100	200	290	400	160	36	55
SD3048	220	360	740	270	65	610	102	210	300	420	170	36	55
SD3052	240	400	820	300	70	680	114	240	330	475	190	43	62
SD3056	260	420	860	320	85	710	116	250	350	500	200	43	62
SD3060	280	460	920	330	85	770	128	280	360	550	210	43	62
SD3064	300	480	940	340	85	790	131	280	370	560	210	43	62
SD3068	320	520	1020	370	100	860	143	310	400	615	230	50	70
SD3072	340	540	1060	390	100	890	144	325	410	640	250	50	70
SD3076	360	560	1080	390	100	900	145	340	410	665	260	50	70

Plummer Blocks

DATA TABLE - SD3000 PLUMMER BLOCK

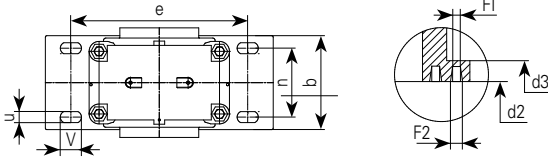

s	d2 H12	d3 H12	f1 H12	f2	Weight Kg	Bearing Nbr	Adapter Sleeve	Spacer	
								Nbr	Qty
M30	153	183	10	13,8	69,5	23034K	H3034	SR260x10	1
M30	163	193	10	13,8	87,3	23036K	H3036	SR280x10	1
M30	173	203	10	13,8	84	23038K	H3038	SR290x10	1
M30	183	213	10	13,8	87	23040K	H3040	SR310x10	1
M30	203	240	11	15,7	131,3	23044K	H3044	SR340x10	1
M30	223	260	11	15,7	150	23048K	H3048	SR360x10	1
M36	243	286	12	17,4	181,5	23052K	H3052	SR400x10	1
M36	263	306	12	17,4	230	23056K	H3056	SR420x10	1
M36	283	332	13	19,1	298	23060K	H3060	SR460x10	1
M36	303	352	13	19,1	331	23064K	H3064	SR480x10	1
M42	323	372	13	19,1	409	23068K	H3068	SR520x10	1
M42	343	392	13	19,1	450	23072K	H3072	SR540x10	1
M42	363	412	13	19,1	458	23076K	H3076	SR560x10	1

Plummer Blocks

DATA TABLE - SD3100 PLUMMER BLOCK

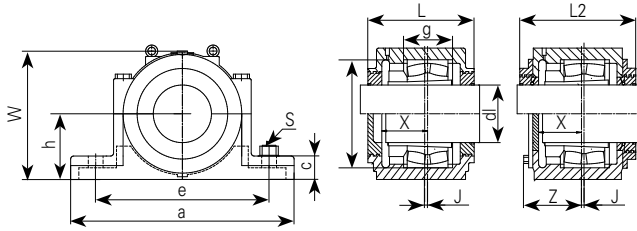

Part number	Shaft dia (mm)	H	a	b	c	e	g	h	L	L2	W	n	u
		H8					H12	h12					
SD3134	150	280	510	180	70	430	108	170	230	308	335	100	30
SD3136	160	300	530	190	75	450	116	180	240	318	355	110	30
SD3138	170	320	560	210	80	480	124	190	260	336	375	120	30
SD3140	180	340	610	230	85	510	132	210	280	356	410	130	35
SD3144	200	370	640	240	90	540	140	220	290	368	435	140	35
SD3148	220	400	700	260	95	600	148	240	310	388	475	150	35
SD3152	240	440	770	280	100	650	164	260	320	400	515	160	40
SD3156	260	460	790	280	105	670	166	280	320	400	550	160	42
SD3160	280	500	830	310	110	710	180	300	350	426	590	190	42
SD3164	300	540	880	330	115	750	196	320	370	448	630	200	42
SD3168	320	580	965	380	120	840	210	340	410	488	670	240	49
SD3172	340	600	1040	390	130	890	212	360	410	498	720	255	49
SD3176	360	620	1120	400	135	980	214	380	430	520	750	255	60
SD3180	380	650	1245	420	140	1050	220	400	430	552	790	270	65

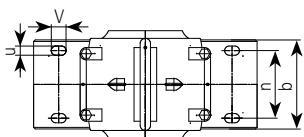

	v	s	J	X	Z	Weight Kg	Bearing Nbr	Adapter Sleeve	Spacer	
									Nbr	Qty
36	M24	14	65	120	56	23134K	H3134	SR280x10	2	
36	M24	15	68	130	68	23136K	H3136	SR300x10	2	
38	M24	10	80	140	72	23138K	H3138	SR320x10	2	
40	M30	10	82	150	92	23140K	H3140	SR340x10	2	
40	M30	12	90	155	106	23144K	H3144	SR370x10	2	
40	M30	12	100	160	142	23148K	H3148	SR400x10	2	
48	M36	13	105	170	165	23152K	H3152	SR440x10	2	
50	M36	16	105	170	195	23156K	H3156	SR460x10	2	
60	M36	22	110	190	223	23160K	H3160	SR500x10	2	
60	M36	23	120	200	257	23164K	H3164	SR540x10	2	
59	M45	25	135	220	488	23168K	H3168	SR580x10	2	
59	M45	22	145	225	482	23172K	H3172	SR600x10	2	
72	M55	22	145	240	540	23176K	H3176	SR620x10	2	
78	M60	22	150	260	606	23180K	H3180	SR650x10	2	

Plummer Blocks

DATA TABLE - CSD3100 PLUMMER BLOCK

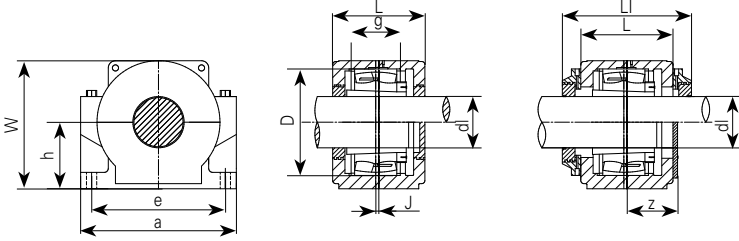

Part number	Shaft dia (mm)	D	a	b	c	e	g	h	L1	L	W	n	u
		H8					H12	h12					
CSD3168TAC	320	580	830	350	70	700	210	360	527	411	708	240	50
CSD3168TS													
CSD3172TAC	340	600	830	350	70	700	212	360	527	411	708	240	50
CSD3172TS													
CSD3176TAC	360	620	880	380	75	760	214	390	547	431	768	280	50
CSD3176TS													
CSD3180TAC	380	650	880	380	75	760	220	390	547	431	768	280	50
CSD3180TS													
CSD3184TAC	400	700	940	400	80	810	244	440	577	461	853	280	50
CSD3184TS													
CSD3188TAC	410	720	940	400	80	810	246	440	577	461	853	280	50
CSD3188TS													
CSD3192TAC	430	760	1040	440	80	880	260	470	617	501	932	310	56
CSD3192TS													
CSD3196TAC	450	790	1040	440	80	880	268	470	617	501	932	310	56
CSD3196TS													

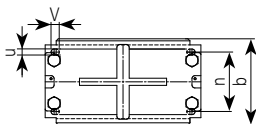

				Weight	Bearing Nbr	Adapter Sleeve	Spacer	
v	J	Z	Kg	Nbr			Qty	
70	30	216,5	593	23168K	H3168	SR580x10	2	
			581					
70	30	216,5	544,8	23172K	H3172	SR600x10	2	
			531,9					
70	35	226,5	741,4	23176K	H3176	SR620x10	2	
			727,7					
70	35	226,5	662,8	23180K	H3180	SR650x10	2	
			648,5					
70	35	241,5	842 856,8	23184K	H3184	SR700x10	2	
70	35	241,5	809,6	23188K	H3188	SR720x10	2	
			794,2					
80	35	261,5	1185	23192K	H3192	SR760x10	2	
			1168,9					
80	35	261,5	1070,8	23196K	H3196	SR790x10	2	
			1054					

Plummer Blocks

DATA TABLE - SD500/SD600 PLUMMER BLOCK

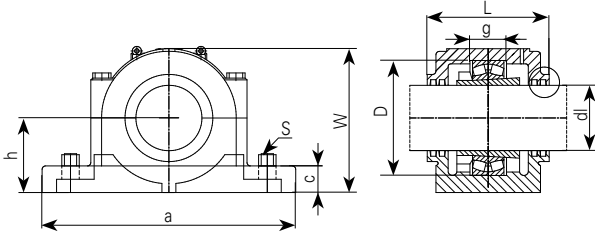

Part number	Shaft dia (mm)												
		D H8	a	b	c	e	g H12	h h12	L	W	n	u	v
SD534	150	310	620	230	60	510	106	180	270	360	140	36	52
SD536	160	320	650	240	60	540	106	190	280	380	150	36	52
SD538	170	340	700	260	65	570	112	200	290	400	160	36	55
SD540	180	360	740	270	65	610	118	210	300	420	170	36	55
SD544	200	400	820	300	70	680	128	240	330	4750	190	43	62
SD548	220	440	880	310	85	70	140	260	340	5150	200	43	62
SD552	240	480	940	340	85	790	150	280	370	560	210	43	62
SD556	260	500	990	370	100	830	150	300	390	590	230	50	70
SD560	280	540	1060	390	100	890	160	325	410	640	250	50	70
SD564	300	580	1110	420	100	930	170	355	440	690	270	58	77
SD634	150	360	740	270	65	610	130	210	300	420	170	36	55
SD636	160	380	780	290	70	640	136	225	320	450	180	43	62
SD638	170	400	820	300	70	680	142	240	330	4750	190	43	62
SD640	180	420	860	320	85	710	148	250	350	500	200	43	62
SD644	200	460	920	330	85	770	155	280	360	550	210	43	62
SD648	220	500	990	370	100	830	165	300	390	590	230	50	70
SD652	240	540	1060	390	100	890	175	325	410	640	250	50	70
SD656	260	580	1110	420	100	930	185	355	440	690	270	58	77

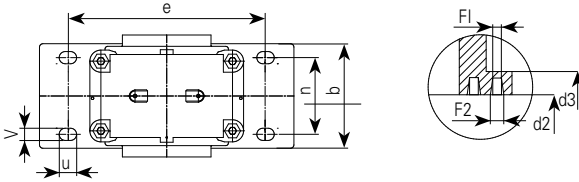

					Weight Kg	Bearing Nbr	Adapter Sleeve	Spacer	
d2 H12	d3 H12	f1 H12	f2	Nbr				Qty	
153	183	10	13,8	92	22334K	H3134K	SR150X10	2	
163	193	10	13,8	106,5	22336K	H3136K	SR160X10	2	
173	203	10	13,8	136,7	22338K	H3138K	SR170X10	2	
183	213	10	13,8	149,2	22340K	H3140K	SR180X10	2	
203	240	11	15,7	209,2	22344K	H3144K	SR200X10	2	
223	260	11	15,7	257,8	22348K	H3148K	SR220X10	2	
243	286	12	17,4	318	22352K	H3152K	SR240X10	2	
263	306	12	17,4	382,3	22356K	H3156K	SR260X10	2	
283	332	13	19,1	478	22360K	H3160K	SR280X10	2	
303	352	13	19,1	577	22364K	H3164K	SR300X10	2	
153	183	10	13,8	149,2	22334K	H3134K	SR150X10	1	
163	193	10	13,8	181,2	22336K	H3136K	SR160X10	1	
173	203	10	13,8	209,2	22338K	H3138K	SR170X10	1	
183	213	10	13,8	248,5	22340K	H3140K	SR180X10	1	
203	240	11	15,7	284	22344K	H3144K	SR200X10	1	
223	260	11	15,7	384,3	22348K	H3148K	SR220X10	1	
243	286	12	17,4	478	22352K	H3152K	SR240X10	1	
263	306	12	17,4	577	22356K	H3156K	SR260X10	1	

Plummer Blocks

DATA TABLE - S(S)N3000 / S(S)N3100 PLUMMER BLOCK

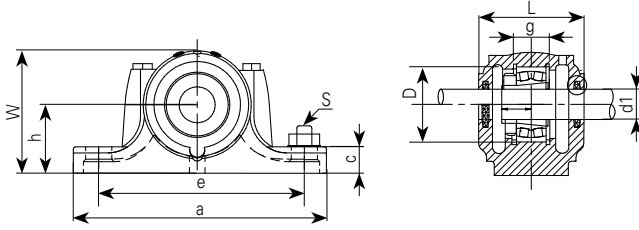

Part number	Shaft dia (mm)												
		D H8	a	b	c	e	g H12	h h12	L	W	n	u	v
S(S)N3024	110	180	380	110	40	320	56	112	160	218	60	26	32
S(S)N3026	115	200	410	120	45	350	62	125	175	240	70	26	32
S(S)N3028	125	210	410	120	45	350	63	140	185	270	70	26	32
S(S)N3030	235	225	445	130	50	380	66	150	175	283	70	28	36
S(S)N3032	140	240	460	130	40	390	70	150	190	300	70	28	38
S(S)N3034	150	260	540	160	50	450	77	160	205	325	90	33	42
S(S)N3036	160	280	550	160	50	470	84	170	215	345	90	33	42
S(S)N3038	170	290	550	160	60	470	85	170	235	345	90	33	42
S(S)N3122	100	180	380	110	40	320	66	112	160	218	60	26	32
S(S)N3124	110	200	410	120	45	350	72	125	175	240	70	26	32
S(S)N3126	115	210	410	120	45	350	74	140	185	270	70	26	32
S(S)N3128	125	225	445	130	50	380	78	150	175	285	70	28	36
S(S)N3130	135	250	500	150	50	420	90	150	205	305	80	33	42
S(S)N3132	140	270	530	160	60	460	96	160	220	325	80	33	42

Plummer Blocks

DATA TABLE - S(S)N3000 / S(S)N3100 PLUMMER BLOCK

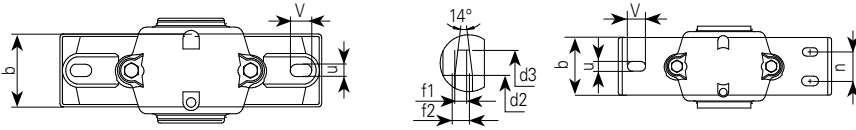

							Weight Kg	Bearing Nbr	Adapter Sleeve	Spacer	
S2	S4	d2 H12	d3 H12	f1 H12	f2	Nbr				Qty	
M24	M16	113	135	8	10,7	17	23024K	H3024	SR180X10	1	
M24	M16	118	140	8	10,7	20	23026K	H3026	SR200X10	1	
M24	M16	128	154	9	12,2	25	23028K	H3028	SR210X10	1	
M24	M20	138	164	9	12,2	30	23030K	H3030	SR225X10	1	
M24	M20	143	173	10	13,7	37	23032K	H3032	SR240X10	1	
M30	M20	153	183	10	13,7	47	23034K	H3034	SR260X10	1	
M30	M20	163	193	10	13,7	55	23036K	H3036	SR280X10	1	
M30	M24	173	203	10	13,7	53	23038K	H3038	SR290X10	1	
M24	M16	102	125	8	10,8	17	23122K	H3122	SR180X10	1	
M24	M16	113	135	8	10,7	20	23124K	H3124	SR200X10	1	
M24	M16	118	140	8	10,7	25	23126K	H3126	SR210X10	1	
M24	M20	128	154	9	12,2	30	23128K	H3128	SR225X10	1	
M30	M24	138	164	9	12,2	38	23130K	H3130	SR250X10	1	
M30	M24	143	173	10	13,7	46	23132K	H3132	SR270X10	1	

Plummer Blocks

DATA TABLE - SAF500 PLUMMER BLOCK

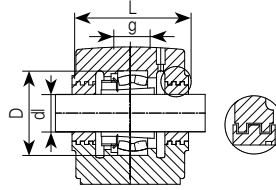
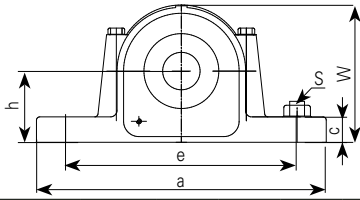

Part number	Shaft dia (mm)	D	a	b	c	e	e	g	h	L	L1	W	n
		H8				max	min	H12	h12				

SAF505	3/4	52	165	45	18	139,7	118	25	38,1	70	73	75	
SAF506	15/16	62	191	51	18	156	133	30	44,5	78	83	86	
SAF507	1-3/16	72	191	51	21	156	143	33	50,8	81	83	97	
SAF509	1-7/16	85	210	61	21	178	159	31	57,2	87	92	111	
SAF510	1-11/16	90	210	61	24	178	165	33	63,5	87	99	121	
SAF511	1-15/16	100	245	70	24	200	188	33	69,9	95	114	133	
SAF513	2-3/16	120	279	80	25	241	206	41	76,2	108	114	151	50,8
FSAF513													
SAF515	2-7/16	130	286	80	29	245	219	41	82,6	118	121	162	47,7
FSAF515													
SAF516	2-11/16	140	330	89	30	279	245	43	88,9	121	124	175	54,1
FSAF516													
SAF517	2-15/16	150	330	89	32	279	251	46	95,3	122	127	186	54,1
FSAF517													
SAF518	3-3/16	160	349	99	33	295	26	50	101,6	140	146	197	54,1
FSAF518													
SAF520	3-7/16	180	387	111	45	333	295	58	114,3	148	152	222	60,5
FSAF520													
SAF522	3-15/16	200	419	121	51	368	321	63	125,4	164	165	245	69,9
SAF524	4-3/16	215	419	121	54	368	337	68	133,4	181	188	260	69,9
SAF526	4-7/16	230	467	130	61	406	372	74	152,4	197	203	292	82,6
SAF528	4-15/16	250	511	149	61	435	406	78	152,4	187	194	298	85,9
SAF530	5-3/16	270	540	159	64	464	432	83	160,4	207	213	318	95,3
SAF532	5-7/16	290	559	159	67	489	442	90	169,9	216	222	338	95,3
SAF534	5-15/16	310	629	172	70	549	492	96	179,4	235	245	360	108
SAF536	6-7/16	320	680	181	76	600	530	96	190,5	245	254	378	117,6
SAF538	6-15/16	340	711	191	80	619	549	102	200	267	273	398	114,3
SAF540	7-3/16	360	749	203	86	635	572	108	209,6	279	286	419	127
SAF544	7-15/16	400	832	222	95	708	629	118	241,3	298	305	473	133,4

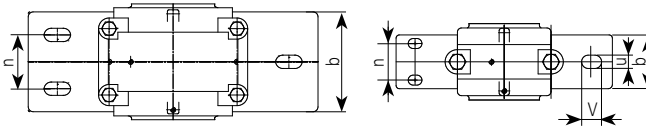

		Weight		Bearing Nbr	Adapter Sleeve	Spacer	
S2	S4	Kg				Nbr	Qty
M12		1,68	1205K		HA205	FR52x5	2
			2205K		HA305	FR52x7	1
M12		2,2	1206K		HA206	FR62x7	2
			2206K		HA306	FR62x10	1
M12		2,7	1207K		HA207	FR72x8	2
			2207K		HA307	FR72x10	1
M12		3,9	1209K	22209K	HA209	FR85x6	2
			2209K		HA309	FR85x8	1
M12		4,4	1210K	22210K	HA210	FR90x6,5	2
			2210K		HA310	FR90x10	1
M16		5,6	1211K	22211K	HA211	FR100x6	2
			2211K		HA311	FR100x8	1
M16	M12	78	1213K	22213K	HA213	FR120x9	2
		78	2213K		HA313	FR120x10	1
M16	M12	8,9	1215K	22215K	HA215	FR130x8	2
		8,9	2215K		HA315	FR130x10	1
M20	M16	10,3	1216K	22216K	HA216	FR140x8,5	2
		10,3	2216K		HA316	FR140x10	1
M20	M16	12	1217K	22217K	HA217	FR150x9	2
		12	2217K		HA317	FR150x10	1
M20	M16	15,9	1218K	22218K	HA218	FR160x10	2
		15,9	2218K		HA318	FR160x10	1
M24	M20	21,8	1220K	22220K	HA220	FR180x11	2
		21,8	2220K		HA320	FR180x10	1
	M20	28	1222K	22222K	HA222	FR200x12,5	2
			2222K		HA322		1
	M20	32,1		22224K	HA324	FR215x10	1
	M24	41,7		22226K	HA326	FR230x10	1
	M24	49		22228K	HA328	FR250x10	1
	M24	61,4		22230K	HA330	FR270x10	1
	M24	68		22232K	HA332	FR290x10	1
	M24	82,1		22234K	HA334	FR310x10	1
	M20	98,4		22236K	HA336	FR320x10	1
	M30	115,6		22238K	HA338	FR340x10	1
	M30	139		22240K	HA340	FR360x10	1
	M30	178,4		22244K	HA344	FR400x10	1

Plummer Blocks

DATA TABLE - SAF600 PLUMMER BLOCK

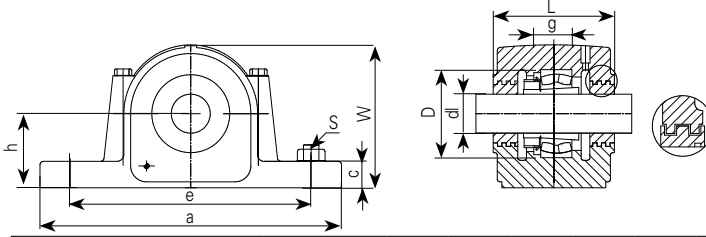

Part number	Shaft dia (mm)	D	a	b	c	e	e	g	h	L	L1	W	n
		H8				max	min	H12	h12				
SAF609	1-7/16	100	245	70	25	200,2	187,5	46	69,9	105	108	135	
SAF610	1-11/16	110	270	70	29	228,6	196,9	51	76,2	114	118	148	
SAF611	1-15/16	120	279	80	30	241,3	206,5	53	82,6	121	124	157	51
FSAF611													
SAF613	2-3/16	140	330	90	32	279,4	244,6	58	88,9	133	137	176	54
FSAF613													
SAF615	2-7/16	160	349	100	33	295,4	263,7	65	101,6	149	159	197	54
FSAF615													
SAF616	2-11/16	170	362	100	33	320,8	270	68	108	156	165	210	54
FSAF616													
SAF617	2-15/16	180	387	111	45	333,5	295,4	70	114,3	165	172	222	61
FSAF617													
SAF618	3-3/16	190	394	111	51	342,9	304,8	74	120,7	168	175	233	57
SAF620	3-7/16	215	419	121	54	368,3	336,6	83	133,3	181	187	260	70
SAF622	3-15/16	240	467	130	61	406,4	371,6	90	152,4	197	203	292	83
SAF624	4-3/16	260	540	160	64	463,6	431,8	96	160,4	207	213	318	95
SAF626	4-7/16	280	559	160	67	489	441,5	103	169,9	216	222	338	95
SAF628	4-15/16	300	629	172	70	549,4	492,3	112	179,4	235	238	360	108
SAF630	5-3/16	320	680	181	76	600,2	530,4	118	190,5	245	248	378	117,6
SAF632	5-7/16	340	711	191	80	619,3	549,4	124	200	267	270	398	114,3
SAF634	5-15/16	360	749	203	86	635	571,5	130	209,6	279	286	419	127
SAF636	6-7/16	380	794	210	89	676	610	136	225,4	282	289	451	133
SAF638	6-15/16	400	832	222	95	708,2	628,7	142	241,3	298	305	473	133,4
SAF640	7-3/16	420	870	229	102	749	667	148	250,8	299	306	508	140

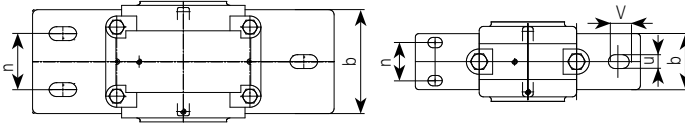

		Weight		Bearing Nbr		Adapter Sleeve	Spacer	
S2	S4	Kg	Nbr				Nbr	Qty
M16		7,2	1309K	21309K	HA309	FR100x10,5	2	
			2309K	22309K	HA2309	FR100x10	1	
M16		9,2	1310K	21310K	HA310	FR110x11,5	2	
			2310K	22310K	HA2310	FR110x10	1	
M16	M12	11	1311K		HA311	FR120x12	2	
			2211K	22211K	HA311	FR100x8	1	
			2311K		HA2311	FR120x10	1	
			2211K	22311K	HA312	FR100x9		
M20	M16	13,3	1313K		HA313	FR140x12,5	2	
			22213K		HA2313			
M20	M16	21	2313K		HA2313	FR140x10	1	
					HA313			
M20	M16	21	1315K		HA315	FR160x14	2	
			22215K		HA2315			
M20	M16	24	2315K		HA2315	FR160x10	1	
					HA314			
M20	M16	24	1316K		HA316	FR170x14,5	2	
			22216K		HA2316			
			2316K		HA2316	FR170x10	1	
					HA315			
M24	M20	27	1317K		HA317	FR180x14,5	2	
			22217K		HA315			
			2317K		HA2317	FR180x10	1	
					HA316			
M20		29,5	1318K	21318K	HA318	FR190x11,5	2	
			2318K	22318K	HA2318	FR190x10	1	
M20		42	1320K	21320K	HA320	FR215x18	2	
			2320K	22320K	HA2320	FR215x10	1	
M20		50	1322K	21322K	HA322	FR240x20	2	
			2322K	22322K	HA2322	FR240x10	1	
M24		72	1324K	21324K	HA324	FR260x20,5	2	
			2324K	22324K	HA2324	FR260x10	1	
M24		77,7	1326K	21326K	HA326	FR280x22,5	2	
			2326K	22326K	HA2326	FR280x10	1	
M24		95	1328K	21328K	HA328	FR300x25	2	
			2328K	22328K	HA2328	FR300x10	1	
M24		118	1330K	21330K	HA330	FR320x26,5	2	
			2330K	22330K	HA2330	FR320x10	1	
M30		128	1332K	21332K	HA332	FR340x28	2	
			2332K	22332K	HA2332	FR340x10	1	
M30		150	1334K	21334K	HA334	FR360x10	1	
			2334K	22334K	HA2334			
M30		170,2	1336K	21336K	HA336	FR380x10	1	
			2336K	22336K	HA2336			
M30		198	1338K	21338K	HA338	FR400x10	1	
			2338K	22338K	HA2338			
M30		255	1340K	21340K	HA340	FR420x10	1	
			2340K	22340K	HA2340			

TECHNICAL NOTEBOOK

ENGINEERING SECTION

ROLLWAY®

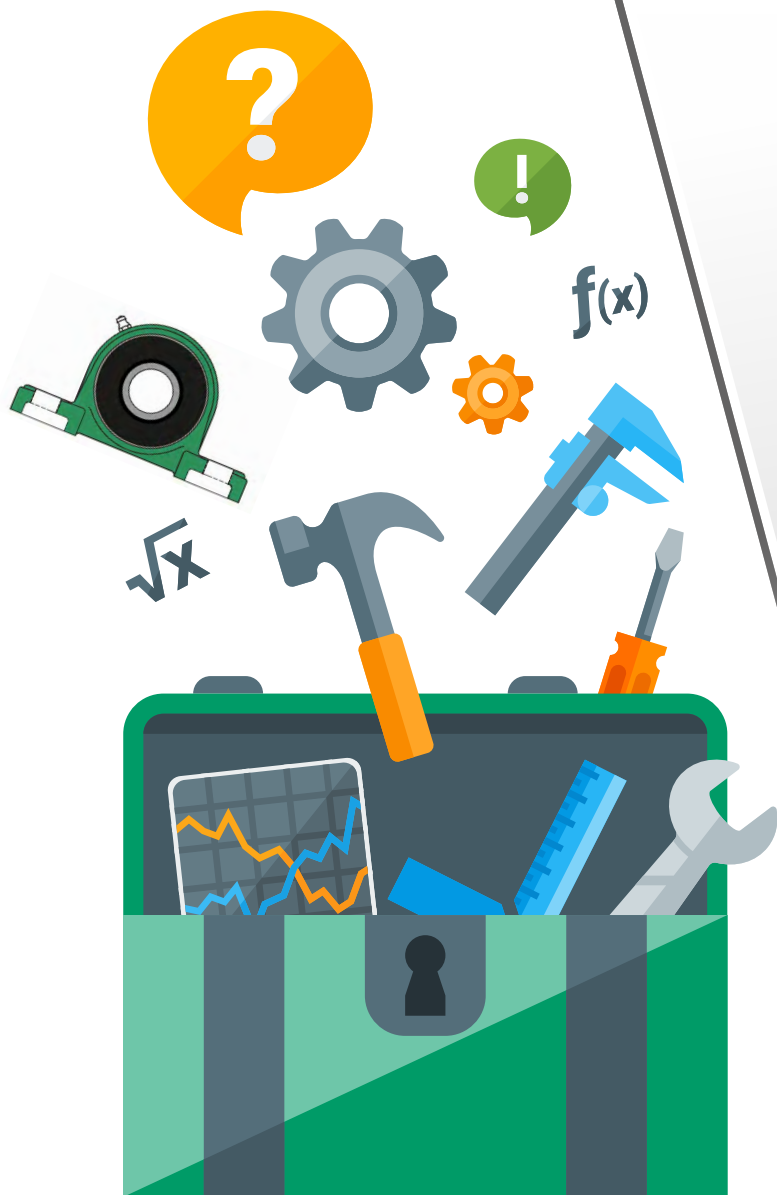

REGAL®

BEARING SELECTION

Selecting of bearing type.....	292
Load and direction of load	292
Radial loads.....	292
Thrust loads	293
Combined loads.....	293
Limiting speed.....	293
Misalignment.....	293
Low noise level.....	293
Rigidity.....	293
Axial movement.....	293
Tapered bore and sleeve mounting	293
Precision.....	293
Determination of rolling bearing size	293
Dynamic loading	293

BEARING LIFE AND LOAD RATINGS

Basic dynamic load rating Cr	296
Static load rating Co.....	296
Rating life.....	296
Life Equations.....	296
Adjusted Rating Life.....	300
Life adjustment factor a1 for reliability	301
Life adjustment factor a2 for material.....	301
Life adjustment factor also for operating conditions	301
Define the rated viscosity V1.....	302
Define the required ISO VG viscosity	302
Factor Kappa (k).....	302
Cleanlines factor (ec)	303
Calculate the load ratio	304
Service life.....	305

LIMITING SPEED

Limiting speed.....	306
---------------------	-----

BEARING MATERIALS

Cage materials.....	307
Heat treatment	307

HANDLING OF BEARINGS

Care & fitting of bearings

Storage	308
Fitting.....	308
Dismantling and replacement.....	309

FITS AND CLEARANCE

Storage - summarizing the orrect radial clearance.....	311
--	-----

SHAFT AND HOUSING FITS

Shaft tolerances for Cylindrical bore bearings.....	313
Shaft tolerances for Thrust bearings	314
Adapter sleeves, withdrawal sleeves	314
Shaft tolerances for adapter sleeves and withdrawal sleeves	315
Housing tolerances for radial bearing	315
Shaft tolerances for Thrust bearings	316
shaft and housing machining tolerances.....	317
Basic tolerance range ISO-IT	318
Deviation of shaft diameters 0,001 mm	318
Deviation of housing diameters 0,001 mm.....	319
Deviation of housing diameters 0,001 mm.....	319
Deviation of shaft diameters 0,001 mm	320
Deviation of housing diameters 0,001 mm.....	320
Fits.....	321

TOLERANCES

Introduction	323
Bore diameter and outside diameter	323
Outside diameter and radial run out	324
Precision class P0 - inner ring (radial bearing - metric size)	325
Precision class P0 - outer ring (radial bearing - metric size).....	326
Precision Class P0 - radial bearings with tapered bore.....	327
Precision class P6 - inner ring (radial bearing - metric size)	327
Precision class P6 - outer ring (radial bearing - metric size).....	329
Precision class P5 - inner and outer ring (radial bearing - metric size)	330
Precision class P4 - inner ring (radial bearing - metric size)	331
Precision class UP - outer ring (radial bearing - metric size)	331
Precision class P0 - inner ring (tapered roller bearing - metric size)	332
Precision class P0 - outer ring (tapered roller bearing - metric size)	332
Precision class P0 - with of inner, outer ring and height (tapered roller bearing - metric size)	333
Precision class P6X.....	333
Precision class P5 - inner ring (tapered roller bearing - metric size)	334
Precision class P5 - outer ring (tapered roller bearing - metric size)	334
Precision class P4 - inner ring (tapered roller bearing - metric size)	335
Precision class P4 - outer ring (tapered roller bearing - metric size).....	335
Precision class according AFBMA standard - inner and outer (tapered roller bearing - inch size)	336
Mounting height on the inner ring roller sub-assembly with outer ring ($\Delta T1S$)	336
Precision class according AFBMA standard - Radial run-out of an assembled bearings (tapered roller bearing - inch size) ..	336
Precision class according AFBMA standard - Tolerances for mounting height ΔT s (tapered roller bearing - inch size)	337
Precision class according AFBMA standard - Tolerances for mounting height ΔT s (tapered roller bearing - inch size)	337
Tolerances for the mounting height on the inner ring roller sub-assembly with outer ring ($\Delta T2S$).....	337
Precision class single acting thrust bearing (single row) - shaft washer.....	338
Precision class single acting thrust bearing (single row) - housing washer	338
Precision class P5 and P6 inner and outer ring (double acting thrust bearing double row).....	339
Precision class single and double acting thrust bearing	339

LUBRICATION.....	340-344
-------------------------	----------------



Bearing Selection

The following procedure gives the steps to be followed when bearings are selected from the information contained in this catalogue. It will be found satisfactory for most applications.

1. a. Determine the speed of the bearing
b. Calculate the loads on the bearings.
2. Establish if accurate alignment can be obtained between the bearing seatings. If it cannot, then bearings that accommodate misalignment should be selected.
3. If the bearings rotate under load decide the life required, calculate the required dynamic load rating 'Cr' values, and then select suitable bearings that have comparable 'Cr' values.
If the bearings do not rotate under load selected them by using the static load rating 'Co'.
4. Check if the bearings are suitable for the speed and decide of grease or oil is to be the lubricant.
5. Refer to shaft and housing tolerance in technical section to ensure required bearing seating fits.
6. Finally:
 - Decide if bearings to 'Standard' or 'Extra Precision' limits of accuracy are required.
 - Select the most suitable range of radial clearance.
 - Choose the abutment diameters.
 - Choose suitable closures.
 - Issue mounting and handling instructions for the bearings if necessary.

SELECTING OF BEARING TYPE

Each type of bearing had different properties making it suitable for certain applications. The factors to be considered when choosing a bearing are numerous so guidance is given to the main points when selecting a bearing. It must also be remembered that special consideration must be given to aspects relating to the running and operating consideration must be given to aspects relating to the cases at least one of the principal dimensions of the bearing has been determined by the machine design or shaft size.

LOAD AND DIRECTION OF LOAD

The magnitude and direction of the external loads along with built in factors of safety are two of the main points which determine the bearing size and in some instances the bearing type to be used. The important factors are the speed of rotation, temperature, the amount of precision required, mounting conditions and running noise.

The following illustrations indicate the magnitude and direction of the external loads which the bearings will provide for.

RADIAL LOADS

For light and medium radial loads ball bearings are generally used, whereas for heavy loads and large shaft diameters roller bearings are often the only choice.

Cylindrical roller bearings are available in several types. Types NU (with outer ring ribs) and N (with inner ring ribs) are only suitable for radial loads, whereas the NUP, NJ and NJ with angle ring HJ can be used to a certain extent to take combined loads.

THRUST LOADS

Thrust ball bearings are only suitable for light or medium purely axial loads. Double-acting thrust ball bearings can carry thrust loads in either direction. Spherical roller thrust bearings are used where heavy thrust loads are to be absorbed and in addition can carry a certain amount of radial load acting simultaneously.

COMBINED LOADS

If a radial and thrust load act on a bearing simultaneously this is termed as a 'Combined Load'. The most important feature affecting the ability to carry axial loads is the angle of contact in relation to the shaft axis. The greater the angle, the more suitable the bearing is to accommodate axial loading. Combined loads are carried by deep groove ball bearings, self-aligning ball bearings single and double row angular contact ball bearings, spherical roller bearings, cylindrical roller bearing of the locating types and taper roller bearings.

LIMITING SPEED

The speeds at which bearings can rotate are limited by the bearing type, the operating load and the permissible operating temperature of the lubricant.

Bearings with low frictional resistance and correspondingly low internal heat generation are most suitable for high speeds with proper attention being given to the correct bearing clearance after mounting.

For radial loads the bearings most suitable are deep groove ball bearings or cylindrical roller bearings... for combined loads angular contact bearings should be selected.

MISALIGNMENT

Self-aligning ball bearings, spherical roller bearings and spherical roller thrust bearings allow, at assembly, for the correction of misalignment where the shaft can be misaligned relative to the housing. Values for permissible angular misalignment are listed in the tables which precede the bearing sizes of those particular types.

LOW NOISE LEVEL

Even though the running noise of rolling bearings is so low that it is lost in the background noise of other moving parts. It is sometimes of prime importance to reduce this to a minimum level for electric motors used for example in lifts for hospitals and hotels and other domestic appliances. Such applications usually demand the fitting of a deep-groove ball bearing selected for low noise level.

RIGIDITY

This is sometimes a very important requirement, especially on machine tool spindles, where rigidity controls the bearing selection. In applications of this nature single or double row cylindrical roller bearing, or taper roller bearings are best suited, compared with the point contact of ball bearings. The stiffness can be further enhanced by pre-loading.



Bearing Selection

AXIAL MOVEMENT

In a normal bearing arrangement supporting a shaft it is usual to locate one bearing (fixed) and allow the non-locating bearing (free) to float in the housing thus preventing axial pre-load as a result of thermal expansion of the shaft. Axial movement produced by thermal expansion can be accommodated by the use of a cylindrical roller bearing of the N or NU pattern. This allows axial movement to occur by displacement of the rollers over the track.

TAPERED BORE AND SLEEVE MOUNTING

Tapered bore bearings are used for easier mounting and adjustments of the radial clearance. It is usual to fit sleeve bearings on bright drawn steel bar thus cutting machining costs and easing assembly. Withdrawal sleeves are used to ease the removal of the bearing. The residual clearance should be checked with the tables relating to the axial drive-up for spherical roller bearings, for that particular bearing size.

PRECISION

Rolling bearings with a higher degree of precision than normal are required for shafts where running accuracy is of prime importance eg, machine tools spindles and shafts rotating at very high speeds (see section relating to bearing tolerances).

DETERMINATION OF ROLLING BEARING SIZE

To determine the size of the bearing static and dynamic load conditions and design life requirements must be considered. The load ratings for the size and type are given in the bearing tables on the appropriate pages.

DYNAMIC LOADING

When a batch of apparently identical bearings is tested under identical load, speed and operating conditions, a wide difference is obtained in the lives of the bearings. Typical results are plotted on the graph; this graph shows the 'rating life' – sometimes called the '90 per cent survival life', and this is the calculated life obtained by following the procedure set out in this catalogue. Also shown is the average life, which is appreciably greater than the 'rating life'.

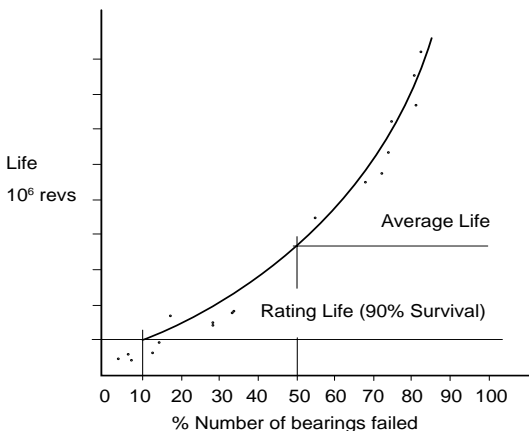

The reason for this difference is that even with the best steel minute imperfections exist in the material and, as the area of contact between the rolling elements and rings under load is very small, these imperfections upset the distribution and intensity of stress in the material. Variations in contact area resulting from the manufacturing tolerances on the rings and rolling elements also contribute towards this difference.

In addition to the load conditions on a bearing, failure can also result from other factors, notably lack of attention to lubrication, protection or accuracy of mounting, but these cannot be included in the basic load/life formulae.

The required basic static load rating C_0 of a bearing can be determined using the equation

$$C_0 = S_0 P_0$$

where:

C_0 = basic load rating [KN]

P_0 = equivalent static load [KN]

S_0 = static safety factor

For bearings operating in elevated temperatures the hardness of the bearing material will be reduced.

Values of S_0 for a few typical non rotating bearing applications are shown below and may be used as a guide.

Application	S_0 Factor
Variable pitch propeller blades on aircraft	0.5
Dams on aircraft	1.0
Swing bridges	1.5
Crane hooks for large cranes without additional dynamic forces	1.5
Small cranes for bulk goods with large additional dynamic forces	1.6

On rotating bearings where the load fluctuates dramatically or, where heavy shock loads occur during a fraction of a revolution, it is necessary to check that the basic static load rating is adequate. Heavy shock loads could cause permanent deformation in the form of indentation being unevenly distributed over the raceway. Shock loads are also generally such that they cannot be calculated exactly. In some cases they may also cause deformation of the housing and therefore producing unfavorable load distribution. Depending on the operating conditions the maximum load should not exceed a value determined by the static safety factor S_0 .

Values for S_0 for certain operating conditions can be used.

Application	S_0 Factor (min ^m)
Operation is smooth and vibration free	0.5
Operation is normal and vibration conditions normal	1.0
Pronounced shock loads	1.5 - 2
Demand on smooth running is of prime importance	2.0

Bearing life and load ratings

BASIC DYNAMIC LOAD RATING C_r

Basic dynamic load rating (C_r) is defined as that constant radial load which a group of apparently identical radial ball bearings, angular contact ball bearings and radial roller bearings can endure for a rating life of one million revolutions.

For thrust ball bearings the basic dynamic load rating is that constant, central, axial load which a group of apparently identical thrust bearings can endure for a rating life of one million revolutions.

STATIC LOAD RATING C_o

The static load C_o is defined as a load acting on a non-rotating bearing. Permanent deformations appear in rolling elements and raceways under static load of moderate magnitude and increase gradually with increasing load. The permissible static load is, therefore, dependent upon the permissible magnitude of permanent deformation.

Experience shows that a total permanent deformation of 0.0001 of the rolling element diameter, occurring at the most heavily loaded rolling element and raceway contact, can be tolerated in most bearing applications without impairment of bearing operation.

RATING LIFE

Rating life (L) is defined as the number of revolutions (or hours at some constant speed) that 90% of a group of apparently identical bearings will exceed before the first evidence of fatigue develops. This may be referred to as B10 life.

LIFE EQUATION

The expression $L_u = (C/P)^3 [10^6 \text{ revs}]$ is used to establish a mathematical relationship for the rating life as a function of the load where.

L_u = rating life in millions of revolutions of the inner ring with constant direction of loading

C = basic dynamic load rating in [KN]

P = equivalent dynamic load rating in [KN]

p = exponent for life equation

$p = 3$ for ball bearings

$p = 10/3$ for roller bearings

In most cases it is common practice to employ the rating life L_h (hours). The relationship between L_u and L_h with constant rotational speed n (rpm) is:

$$L_u = \frac{L_h \cdot n \cdot 60}{10^6} \cdot [10^6 \text{ revs}]$$

If the rating life of 1×10^6 revs, to which the basic load rating C refers, is resolved into a reference life $L_h = 500$ hours, and a reference rotation speed of $n = 33.1/3$ rpm it follows that

for ball bearings: $\left(\frac{C}{P}\right)^3$ for roller bearings: $\left(\frac{C}{P}\right)^{\frac{10}{3}}$

$$L_u = \frac{Lh.n.60}{500.33.1/3.60} = \left(\frac{C}{P}\right)^3 [10^6 \text{ revs}]$$

$$\text{or: } \sqrt[3]{\frac{LH}{500}} = \sqrt[3]{\frac{33.1/3}{n} \cdot \frac{C}{P}}$$

$$\text{letting: } \sqrt[3]{\frac{33.1/3}{n}} = \text{speed factor } f_n \text{ (equation 1)}$$

$$\text{and: } \sqrt[3]{\frac{LH}{500}} = \text{life factor } f_L \text{ (equation 2)}$$

The rating life equation may be obtained in the form life factor: $f_L = \frac{C \cdot f_n}{P}$

$$\text{basic load rating required: } C = \frac{P \cdot f_L}{f_n} \text{ [KG]}$$

The relationship of equation 1 and 2 are graphically represented in nomograms below. Also on page 14 are charts showing the L10 life in relation to C/P for ball and roller bearings. To determine the size of a rolling bearing for a particular field of operation it is necessary to establish the nominal life corresponding to the field of application.

EXAMPLE

A deep groove ball bearing is required to run at speed $n=850$ RPM under constant radial load of $f_r = 5$ KN and is to achieve a basic rating life L10h of 20.000 hours.

From the nomogram using the right hand column (L10) a line drawn from 20.000 to the left hand column (n RPM) this passes through the centre column (C/P L10 10.6) at 10:1000 therefore a bearing is required with a basic load rating C of at least $C = 10 \times 5$ KN. Reading from the tables relating to deep groove ball bearings it can be seen that a bearing ref 6309 has a C value of 52.7 KN. Of course the choice of bearing is also governed by the shaft and housing parameters.

For motor vehicles and rolling stock the service life is expressed as a function of the wheel diameter and kilometers travelled as per formulae below.

$$L_{10} = \frac{1000}{\pi D} \cdot L_{10s} \quad \text{or} \quad L_{10s} = \frac{\pi D}{1000} L_{10}$$

Where:

L10 = nominal life in 10^6 RPM

L10s = life in 10^6 kilometers traveled

D = diameter of wheel in meters. Values for selecting service life in kilometers covered are in table below.



Bearing life and load ratings

Vehicle type	L10s/10 ⁶ km
Wheel bearings for motor vehicles:	
Cars	0.2
Trucks, buses	0.4
Axle boxes for rolling stock – freight cars	0.8
Suburban traffic	1.5
Long distance coaches	3
Rail cars	3-1
Diesel and electric locomotives	3-4

Depending on the working temperature of the bearings, their service life is reduced at elevated temperatures.

This is to be taken into consideration when the service life is established by the application of temperature factor f_t specified in table.

Working temperature °C	150	200	250	300
Symbol	S0	S1	S2	S3
f_t	1	0.73	0.42	0.22

In the following table are some recommendations for factor f_v along with typical applications and life factor f_L .

Application	Fields of operating conditions	Factor f_v	Factor f_L
Motor vehicles - gear boxes - axle drives - water pumps - wheel bearings	g – k h – k k h – l	3 – 8 3 – 6 5 – 7 4 – 6	1.7 – 2.2 2 – 3 1.5 – 2 1.6 – 2.5
Railbound vehicles - haulage trolleys - trams - passenger coaches and freight cars - motor coaches and locomotives - gears	f – h e – f c – d d – e c – d	12 – 15 8 – 12 8 – 12 6 – 10 3 – 6	2.5 – 3 3.5 – 4 3 – 3.5 3.5 – 4 3 – 4.5
Motors - electric motors for household appliances - traction motors and standard motors - large motors	i – k c – d b – d	3 – 5 3 – 5 3 – 5	1.5 – 2 3.5 – 4.5 4 – 4.5

Bearing life and load ratings

Application	Fields of operating conditions	Factor f_v	Factor f_L
Machine-tools - lathe spindles and milling spindles - boring and grinding machine spindles - machine tool gears - electric and pneumatic tools	a – b c – d c – d g – h	0.5 – 1.5 0.5 – 1 3 – 8 3 – 6	3 – 4.5 2.5 – 3.5 3 – 4 1.8 – 2.7
Woodworking machines - milling cutter and cutter shaft - main bearing - rod bearing	e – f e – g c – d	0.5 – 3 3 – 4 2 – 3	3 – 4 3 – 4 2 – 3
Gears general engineering - universal gears - large-sized gears, stationary	d – c c – d	3 – 1 2 – 3	2 – 3 2 – 3
Materials handling - belt drives opencast mining - medium-sized and large fans - centrifugal pumps and compressors	c – d c – l d – f	5 – 12 3 – 5 3 – 5	4 – 6 3 – 4.5 3 – 4.5
Crushers, mills, screens etc. - jaw crushers, roll crushers	f – g	8 – 12	3 – 3.5
Hammer mills - hammer mills and impact mills - tube mills - vibrating mills - vibrating screens	d – c f – g f – g e – f	5 – 8 12 – 18 3 – 5 4 – 6	3.5 – 4.5 3 – 5 2 – 3 2.5 – 3

The wear life diagram indicates the operating conditions with the least wear factor at curve A and the heaviest wear occurring at curve B. The area between A and B being subdivided into individual fields from a to k. It can be seen that the operating conditions deteriorate progressively.

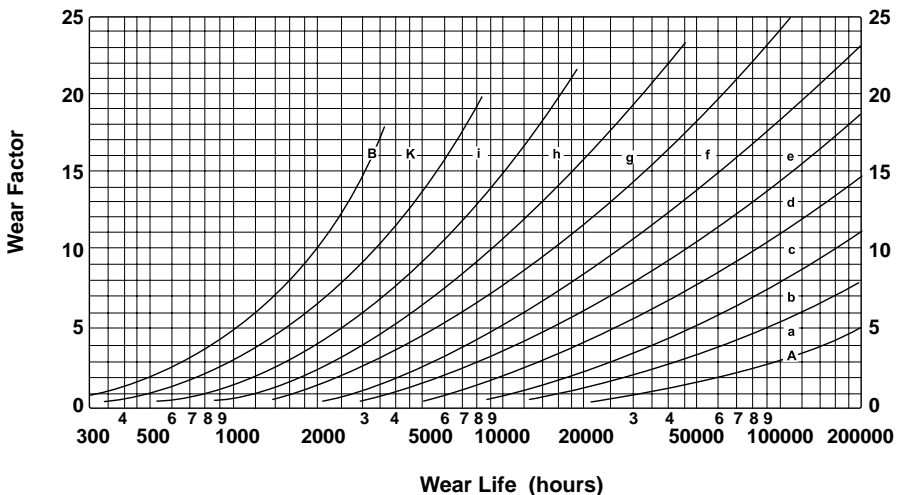

Bearing life and load ratings

ADJUSTED RAITING LIFE

Adjustments to life equations

$$L_{10} = \left(\frac{C}{P}\right)^p$$

The above formula is adequate for conventional applications but in exceptional cases other factors must be considered which influence the life of the bearing. To accommodate these factors the ISO life equation is

$$L_{na} = a_1.a_2.a_{iso} \cdot \left(\frac{C}{P}\right)^p \quad \text{or} \quad L_{na} = a_1.a_2.a_3.L_{10}$$

Where:

L_{na} = adjusted rating life in 10^6 revolutions the index being the difference between the specified probability life and 100%

a_1 = life adjustment factor for reliability

a_2 = life adjustment for material

a_{iso} = life adjustment for operating conditions including tribology

Calculations for the adjusted rating life are based on the pre-conditions mentioned in the above formulae ie. That bearing loads can be calculated with accuracy considering all aspects of the loads involved along with shaft deflection etc.

Also, that reliability of the bearing materials are in accordance with the corresponding C values and that normal operating conditions $a_1=a_2=a_3=1$ and that two life equations become identical.

Life adjustment factor a_1 for reliability

The a_1 factor is used to determine lives which are obtained or exceeded with a greater probability than 90% (L10). The table below lists the factors for failure probability values between 10% and 1% L10 being the normal rating life.

Probability %	Failure probability %	Life before fatigue appears	Factor a_1
90	10	L10	1
95	5	L5	0.62
95	4	L4	0.53
97	3	L3	0.44
98	2	L2	0.33
99	1	L1	0.21

Life adjustment factor a_2 for material

The factor a_2 accounts for the properties of the material and its heat treatment. $a_2=1$ is applicable to the high quality steels used in the production of normal bearing series. For elevated temperatures see reduction in dynamic load rating in table below.

Working temperature °C	150	200	250	300
Symbol	S0	S1	S2	S3
ft	1	0.73	0.42	0.22

Life adjustment factor a_{iso} for operating conditions

The efficiency of lubrication is determined primarily by the degree of separation between the rolling elements and raceways. The highest life values are reached when there is a hydrodynamic state of lubrication where metal to metal contact does not exist between rolling elements and raceway and under the cleanliness conditions which would normally prevail in an adequately sealed bearing arrangement.

The a_{iso} factor can be calculated or estimated graphically. Below we cover the graphical method.



Bearing life and load ratings

Define the rated viscosity V1

Define the rated viscosity based on bearing mean diameter (Dm) and speed (n). In the left graphic, find the intersection between n and Dm. Report it on the V1 axis to obtain the rated viscosity.

DEFINE THE REQUIRED ISO VG VISCOSITY

Define the required ISO VG viscosity suitable for the application (Right graphic). Mark the V_1 value on the Y axis and the operating temperature (t) on the X axis. Select a ISO VG hyperbolic above the intersection of V_1 and t. select 1 or 2 above.

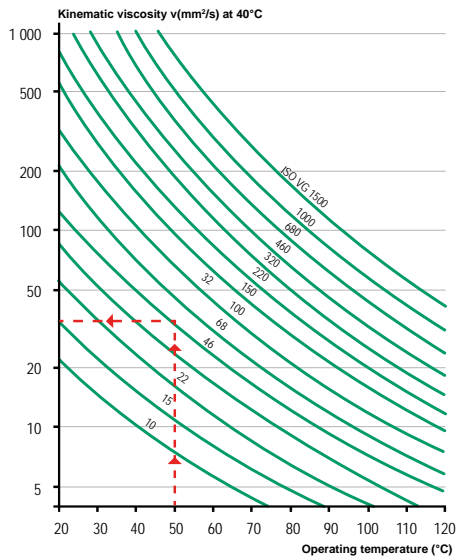
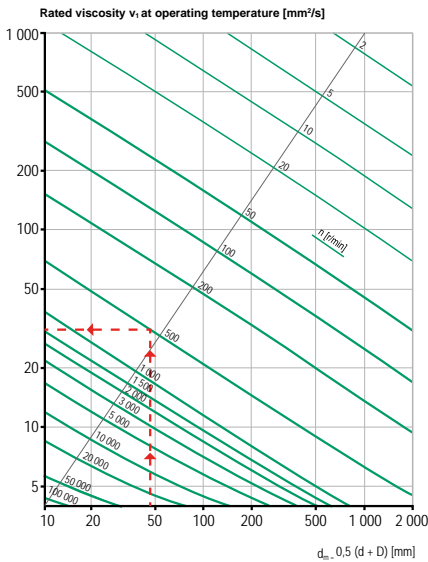

FACTOR KAPPA (K)

The a_{iso} factor is based on the viscosity ratio Kappa (K) It is defined as the ratio of the actual lubricant viscosity V for the viscosity v_1 required for adequate lubrication. K should be higher than 1 With thinner lubricating films, there is an increase in metal to metal contact and life expectancy decreases.

$$kappa = V / V_1 \gg 1 \gg 4$$

Cleanliness factor (ec)

Level of contamination	ec	
	$D_{pw} < 100 \text{ mm}$	$D_{pw} \geq 100 \text{ mm}$
Extreme cleanliness Particle size of the order of lubricant film thickness; laboratory conditions	1	1
High cleanliness Oil filtered through extremely fine filter; conditions typical of bearing greased for life and sealed	0,8 to 0,6	0,9 to 0,8
Normal cleanliness Oil filtered through fine filter; conditions typical of bearings greased for life and shielded	0,6 to 0,5	0,8 to 0,6
Slight contamination Slight contamination in lubricant	0,5 to 0,3	0,6 to 0,4
Typical contamination Conditions typical of bearings without integral seals; coarse filtering; wear particles and ingress from surroundings	0,3 to 0,1	0,4 to 0,2
Severe contamination Bearing environment heavily contaminated and bearing arrangement with inadequate sealing	0,1 to 0	0,1 to 0
Very severe contamination	0	0

Select the appropriate ec for the application.



Bearing life and load ratings

CALCULATE THE LOAD RATIO

$$e_c Cu / Pe$$

Where:

- e_c = Cleanliness factor
- Cu = Fatigue limit load rating
- Pe = Equivalent load

a_{iso} factor is

$$a_{iso} = f(k, e_c Cu / Pe)$$

Where:

- k = Kappa factor

In the below graphics, report the load factor on the X axis and select the kappa hyperbolic. Report the intersection point on the a_{iso} axis. The a_{iso} adjustment factor. depending the bearing type, use the left graphic for ball bearing or right graphic for roller bearing

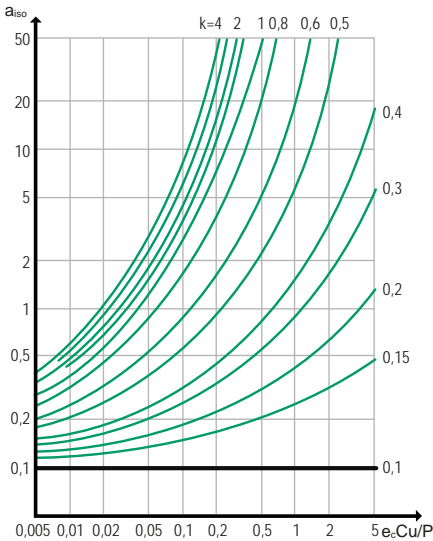

BALL

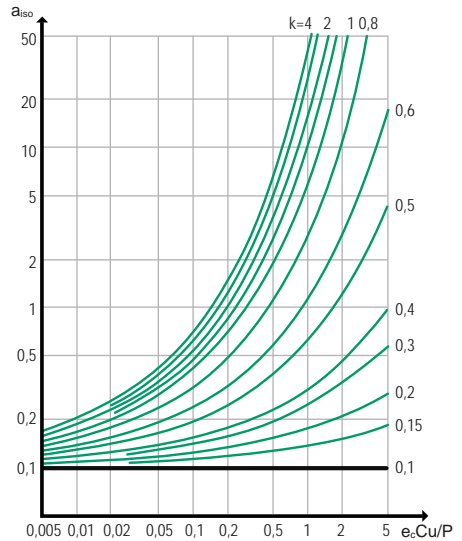

ROLLER

SERVICE LIFE

Since the fatigue life modified by the adjustment factors a_1 , a_2 and a_{iso} only considers material fatigue as the cause of failure, the calculated life corresponds to the service life only if the following points are met.

- (a) Lubrication conditions are constant throughout.
- (b) Loads and speeds used for analysis are a true reflection of the actual operating conditions.
- (c) Operating viscosity is based on actual operating temperature.
- (d) Lubricant contamination is limited during the whole running time.
- (e) The service life limited by wear and break down of lubrication is not shorter than the fatigue life.

Wear of the acting surfaces is primarily caused by contamination which over a period of time may penetrate the bearing. The situation is made worse by inadequate lubrication and corrosion due to condensation. The amount of wear experienced in a bearing is dependent on the operating conditions, lubrication and effective sealing arrangement.

WEAR FACTOR

The permissible amount of wear is expressed by the wear factor f_v .

$$f_v = \frac{v}{e_o}$$

where:

v = permissible increase in radical clearance (mm)

e_o = bearing constant depending on the bore diameter – see below for e_o values in relationship with bore diameter mm.

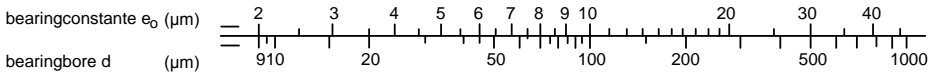

Limiting Speed

LIMITING SPEED

The maximum rotational speed of ball and roller bearings depends upon various factors. The size and design of the bearing, type of lubrication whether grease or oil and type of cage fitted along with the internal clearance of the bearing when mounted.

If the radial run-out, which produces out of balance forces, is reduced, then higher speeds can be obtained for such as machine-tool applications, hence the use of high precision bearings. Reduction of cage weight will also reduce out of balance forces as when made from light alloy or plastic. Cages that are centred on the inner or outer races rather than the rolling elements are used for high speed applications.

The surface of the riding lips being specially ground; lubrication between the sliding surface must be maintained. Heavier loads influence the speed and also effect the basic rating life of L10h75000 hours.

In such cases the speeds listed in the tables should be multiplied by a factor f which you can obtain from the fig. 1.

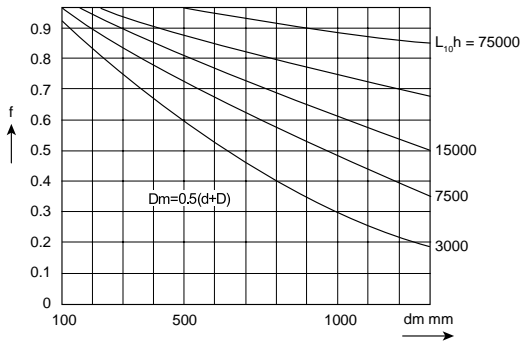

For combined loads the speeds indicated in the bearing tables are to be multiplied by the reduction factor f_1 given in diagram fig. 2.

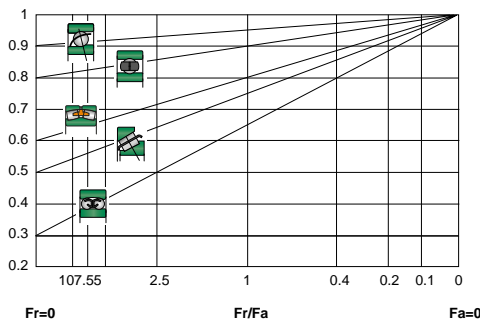

For ball thrust bearings there must be a minimum load applied to counteract the centrifugal forces of the balls on rotation. Factor M is indicated in the bearing tables against the appropriate bearing size.

Bearing rings and rolling elements are subjected to high stresses on a very small contact area and must have a high resistance to wear as well as high elastic and fatigue limits. Primarily these are manufactured from high-carbon chromium bearing steel with a chemical composition as indicated in the table 1 below and are in accordance with SAE 52100 - 100 Cr6.

HIGH CARBON CHROMIUM BEARING STEEL Steel Grade	Chemical Composition %					
	C	Mn	Si	Cr	S	P
105Cr4	1.00..1.10	0.25..0.40	0.15..0.35	0.90...1.15	<0.025	<0.030
100Cr6 / ROL 2	0.90..1.05	0.25..0.40	0.15..0.35	1.40..1.65	<0.025	<0.025
100CrMn6	0.90..1.05	1.00..1.20	0.50..0.70	1.40...1.60	0.020	<0.025

CAGE MATERIALS

Types of cages for bearings vary in accordance with the operating conditions. The most common are those made from pressed steel. Machined cages are made from high strength copper alloys or carbon steel and for high speeds manufactured from plastic or phenolic resins.

HEAT TREATMENT

Bearings are generally used up to a temperature of maximum + 150°C. In case of higher temperatures, bearings with special heat treatments should be used. Sealed bearings, 2RS type, should be used at operating temperatures up to +80°C. If this temperature is exceeded, the efficacy of lubricants is considerably reduced.

In order to use bearings at a higher operating temperature, the bearings have to be subjected to a special heat treatment. This will ensure the dimensional stability, but will reduce the lifetime by a factor (ft) as per the table.

Operating temp °C	150	200	250	300
Symbol	S0	S1	S2	S3
ft	1	0.73	0.42	0.22

Handling of bearings

CARE & FITTING OF BEARINGS

STORAGE

1. Store ball and roller bearings in a clean, dry place in their original wrappings. This will preserve them from deterioration.
2. Use older stocks first.
3. Do not stack too many large bearings on top of each other otherwise the protective oil could be squeezed out from between the bearing and its wrapping, thus leading to corrosion problems. Also, never store large bearings upright, but lay them flat.

FITTING

4. Absolute cleanliness is essential when handling bearings. They should not be removed from their wrappings until required for fitting. A smooth metal topped bench that can be wiped clean is a great advantage. All tools, shafts, housings and other components must be perfectly clean. If fitting operations are delayed or interrupted, the assembly should be wrapped with grease proof paper to exclude dirt and dust.
5. All bearings are usually coated with a rust preventative oil, unless pre-lubricated and/or packed to suit individual requirements. There is no need to remove this oil unless:
It is sufficient to cause serious dilution of the oil or grease used in the bearing. This normally applies to smaller bearings where the rust preventative oil represents a large proportion of the required amount of lubricant.

Low torque is required.

A synthetic lubricant is used that may not be compatible with the protecting oil.

To remove the rust preventative oil, wash the bearing in a good-quality washing fluid; white spirit or good-quality paraffin are suitable. Allow the bearings to drain thoroughly. Finally dry them, the following being satisfactory methods.

Place the bearing in an oven or on a hot plate, temperature of 65-80°C should be adequate.

Direct dry, clean, compressed air on to the bearings. The cage and rings of smaller bearings must be held firmly otherwise a sudden blast of air would rapidly accelerate the free bearing parts; this could cause the balls to skid, thus damaging the highly finished internal surfaces of the bearing.

The fits of the rings on their seatings are very important. Therefore, ensure that the shaft and housing seatings are of correct size and of good shape.

7. All shoulders must be smooth and square with the axis of rotation.
8. Never drive one ring on to its seating by blows on the other. Such blows would irretrievably damage the balls or rollers and raceways.
9. Apply pressure evenly around the rings. A press is better than a hammer.
10. Should a hammer be used, mild steel or brass tube of suitable size, faced up square, should be interposed between it and the bearing. This will distribute the force of the blows (or rather taps), which should be given progressively around the ring.

11. When the parts of a separable roller bearing are brought together, the inner ring, the outer ring and the rollers must all be square one with the other. If not square, then the rollers would not slide freely, and force would have to be used to bring the parts together. Such force would result in the rollers and raceways becoming scored and this, in addition to causing noisy running, could cause early failure of the bearing.
12. Where the ring of a bearing is to be against an abutment, make sure it is properly seated.
13. For heavy interference fits, inner rings may be shrunk onto their seating's after heating in clean mineral oil at a temperature of approximately 100%. Be sure that the bearing is in contact with the abutment shoulder after it has cooled.
14. In the case of taper clamping sleeve and nut bearings, the clamping nut must not be overtightened, this could expand the inner ring and eliminate all clearance within the bearing, or even fracture the inner ring.

It is recommended that when using pin spanners they should have a length of approximately five times the shaft diameter, one or two light hammer blows should be given to the handle of the spanner after the nut has been tightened as far as possible by hand pressure; this should tighten the nut sufficiently. It is good practice, if possible, to check that the sleeve is still clamped firmly to the shaft after a few days running.

As an additional precaution it is recommended that, whenever possible, the bearings are fitted so that the rotation of the shaft tends to tighten the nut on the sleeve.

When using torque spanners it is recommended that the following torques be applied to the clamping nut.

For LIGHT series bearings

Shaft Diameter	Torque on Nut
1" and 25m/m	7.6 Kgm/M (55 lbs ft)
1 1/2" and 40 m/m	12.4 Kgm/M (90 lbs ft)
2" and 50 m/m	17.25 Kgm/M (125 lbs ft)
3" and 75 m/m	30.3 Kgm/m (220 lbs ft)

For MEDIUM series bearings increase the above figures by approximately 50 percent.

DISMANTLING AND REPLACEMENT

Unnecessary removal of a bearing should be avoided, particularly where interference fits have been used. Removal can damage a bearing and, in some instances, cause deterioration of the interference fit. Very often it is sufficient to clean and relubricate the bearing in its fitted position.

Only remove a bearing if you need to inspect it closely. Symptoms that guide are the condition of the lubricant, the bearing temperature and noise level.

16. With roller journal bearings there is sometimes a ball locating bearing. this may be only push fit on the shaft, and therefore facilities easy dismantling.



Handling of bearings

17. In certain application some form of extractor may be necessary. This must act directly on the ring to be removed. Never try to remove the inner ring by applying force to the outer ring, or vice versa.
18. Thrust bearings offer no difficulty as push fits should have been used; but, take care to keep the rings square or they will bind.
19. Carefully protect bearings from dirt moisture whilst they are out of their housings.

It is advisable to wash them thoroughly immediately after removal, by the following procedure.

Immerse in a washing fluid such as clean white spirit or good-quality paraffin. The washing fluid must not attack the bearing components. After Soaking, move each separate bearing around in the fluid, using a basket or other container if convenient. Occasional slow oscillations of the bearing rings will help to dislodge dried out grease and other matter.

When clean, thoroughly drain and dry.



The Radial clearance is the total internal clearance between the balls or rollers in a bearing and their raceways measured normal to the axis of the bearing. This clearance compensates for (a) expansion of the inner ring and/or contraction of the outer ring when interference fits are used, (b) for differential expansion of the two ring when the inner ring of a bearing operates at a higher temperature than the outer ring; (c) accommodates the minute inaccuracies unavoidable with even the most modern methods of machining; (d) affects the end play and also affects their capacity for carrying axial loads – the greater the radial clearance, the greater the capacity for supporting axial load.

When bearings with small radial clearances are used, special attention must be given to the selection of seating dimensions.

Once ball and roller bearings are mounted and running, a small amount of radial or running clearance is normally desirable. In the case of bearings under radial load, quieter running is generally obtained when this clearance is a minimum.

Radial clearance figures for Ball and Roller bearings mentioned in our Tables are in accordance with I.S.O. 5753 recommendations.

For normal applications the general guide given in Table 1 below may be used. Excessive radial tightness in the bearing should be avoided under all conditions.

STORAGE

TABLE 1 – SUMMARIZING THE CORRECT RADIAL CLEARANCE

Radial clearance of bearing	Fit of races on seating	Possibility of temperature changes reducing radial clearance
C2	No appreciable interference either race	absent
CN	One race only interference fit	absent
C3	One race only interference fit	present
C3	Both races interference fit	absent
C4	Both races interference fit	present

C2 fit: These bearings have the smallest amounts of radial clearance. They should only be used where freedom from all play is required in the assembled bearing and there is no possibility of the initial radial clearances being eliminated by external causes. Therefore, special attention must be given to the seating dimensions, as the expansion of the inner ring or contraction of the outer ring may cause tight bearings.

CN fit: This grade of radial clearance is intended for use where only one ring is made an interference fit and there is no appreciable loss of clearance due to temperature differences. Ball and Roller bearings for general engineering applications are usually of this clearance.

C3 fit: This grade of radial clearance should be used when both rings of a bearing are made an interference fit, or when only one ring is an interference fit but there is likely to be some loss of clearance due to temperature differences. It is the grade normally employed for roller bearings on general engineering applications, especially where there is a tendency for “creep” to take place due to out-of-balance loading.



Fits and clearance

It is also the grade normally used for ball bearings that take axial loading, but for some purposes even “C4” fit bearings may be required.

C4 fit: Where there will be some loss of clearance due to temperature differences and both races must be an interference fit, this is the grade of radial clearance to adopt. One example of its use is in bearings for vibration screen.

Where seating limits give an interference fit tighter than the recommended figures, or where temperature differences could cause radial tightness, the correct clearance can be established by calculating the maximum loss of clearance at both extremes of the following basis. A suitable clearance grade from the tables can then be selected.

Total loss of clearance = RI + RO + RT + RM

RI = Expansion of inner ring raceway due to shaft interference. (See table below).

RO = Contraction of outer ring raceway due to housing interference. (See table below).

RT = Loss of clearance due to the inner ring being at a higher temperature than the outer ring.

RM = Loss of clearance due to increase in seating interference resulting from nonferrous seating expanding or contracting at different rates from bearing steel.

Table 2 below gives approximate values for RO and RI assuming a solid shaft and substantial housing.

TABLE 2

Bearing series	Inner ring raceway expansion RI	Outer ring raceway Contraction RO
Extra light	100% interference	80% interference
Light	80% interference	60% interference
Medium and heavy	70% interference	50% interference

For the clearance tables, refer to the bearing type chapter

SHAFT TOLERANCES FOR CYLINDRICAL BORE BEARINGS

Type of Load	Bearing type	Diameter	Axial Movement Magnitude of Load	Tolerance field	
Rotating Outer Ring Load	Ball & Roller Bearing	All sizes	Angular contact ball bearing and tapered roller bearing adjustment via inner ring	g6 h6 h6	(g5) (h5) (j6)
Rotating Inner Ring or indeterminate Load	Ball Bearing	Up to 40mm	normal load	J6	(j5)
		Up to 100mm	low load normal & high load	J6 k6	(j5) (k5)
		Up to 200mm	low load normal & high load	K6 m6	(k5) (m5)
		Over 200mm	normal load high load, shock load	M6 n6	(m5) (n5)
-	Roller Bearing	Up to 60mm	low load normal & high load	J6 k6	(j5) (k5)
		Up to 200mm	low load normal load high load	K6 m6 n6	(k5) (m5) (n5)
		Up to 500mm	normal load high load, shock load	m6 p6	(m5)
		Over 500mm	normal load high load	N6 p6	(n5)



Shaft and housing fits

SHAFT TOLERANCES FOR THRUST BEARINGS

Type of Load	Bearing type	Diameter	Operating conditions	Tolerance field	
Thrust load	thrust ball bearings	all sizes		J6	
	thrust ball bearings double acting	all sizes		J6	(k6)
	cylindrical roller thrust bearing	all sizes		h6	(j6)
	thrust cylindrical roller & cage assembly	all sizes		h10	
	thrust cylindrical roller & cage assembly or thrust needle roller & cage assembly	all sizes		h8	
Combined Load	spherical roller thrust bearing	all sizes	point load on shaft washer	j6	
		up to 200mm	circumferential	j6	(k6)
		over 200 mm	load on shaft washer	k6	(m6)

ADAPTER SLEEVES, WITHDRAWAL SLEEVES

	Permissible geometrical inaccuracy (out-of-roundness taper)	Tolerance field
Adapter sleeves and withdrawal sleeves	IT 5/2	H7
	IT 5/2	h8
	IT 6/2	h9

SHAFT TOLERANCES FOR ADAPTER SLEEVES AND WITHDRAWAL SLEEVES

d mm		H7			IT 5/2			h8			IT 5/2			h9			IT 6/2		
µm																			
over	up to	upper	lower	max.	upper	lower	max.	upper	lower	max.	upper	lower	max.	upper	lower	max.	upper	lower	max.
0	0	0	0	0	0	0	0	0	0	0	0	0	0	0	0	0	0	0	0
6	10	0	-15	3	0	-22	3	0	-36	4.5	0	-43	5.5	0	-52	6.5	0	-62	8
10	18	0	-18	4	0	-27	4	0	-43	5.5	0	-52	6.5	0	-62	8	0	-74	9.5
18	30	0	-21	4.5	0	-39	4.5	0	-52	6.5	0	-62	8	0	-74	9.5	0	-87	11
30	50	0	-25	5.5	0	-39	5.5	0	-62	8	0	-74	9.5	0	-87	11	0	-100	12.5
50	80	0	-30	6.5	0	-46	6.5	0	-74	9.5	0	-87	11	0	-100	12.5	0	-115	14.5
80	120	0	-35	7.5	0	-54	7.5	0	-87	11	0	-100	12.5	0	-115	14.5	0	-130	16
120	180	0	-40	9	0	-63	9	0	-100	12.5	0	-115	14.5	0	-130	16	0	-140	18
180	250	0	-46	10	0	-72	10	0	-115	14.5	0	-130	16	0	-140	18	0	-155	20
250	315	0	-52	11.5	0	-81	11.5	0	-130	16	0	-140	18	0	-155	20	0	-170	22.5
315	400	0	-57	12.5	0	-89	12.5	0	-140	18	0	-155	20	0	-170	22.5	0	-185	25
400	500	0	-63	13.5	0	-97	13.5	0	-155	20	0	-170	22.5	0	-185	25	0	-200	27.5

Note: IT basic tolerances indicate accepted from circularity and cylindricity

HOUSING TOLERANCES FOR RADIAL BEARING

Type of Load	Axial Movement Magnitude of Load	Operation Conditions	Tolerance field	
Rotating inner Ring Load	Outer Ring slides in Housing	closeness of tolerance function of running accuracy	H7	(H6)
		high running accuracy	H7	(J6)
		standard running accuracy	H7	(J6)
		temperature increase through shaft	G7	
Rotating Outer Ring Load or indeterminate load	low load	with high running accuracy requirements K6, M6, N6 and P6	K7	(KJ6)
	normal load, shock load		M7	(M6)
	high load, shock load		N7	(N6)
	high load, heavy shock load thin-walled housings		P7	(P6)

Shaft and housing fits

SHAFT TOLERANCES FOR THRUST BEARINGS

Type of load	Bearing type	Operating conditions	Tolerance field	
Thrust load	thrust ball bearings	standard running accuracy	E8	(K6)
		high running accuracy	E6	
	cylindrical roller thrust bearing		H7	
		thrust cylindrical roller & cage assembly	H11	
	thrust cylindrical roller & cage assembly	H10		
	spherical roller thrust bearing	normal load	E8	
high load		G7		
Radial & axial loads on spherical roller thrust bearings	stationary load on housing washer		H7	
	rotating load on housing washer		M7	

Accuracy of shaft

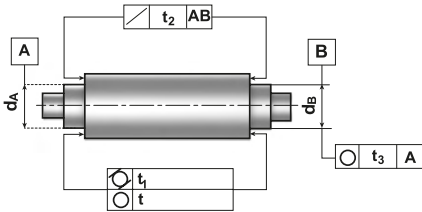

Accuracy of housing

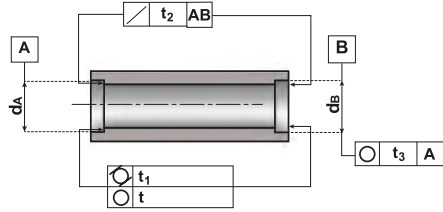

Description	Fit	Symbol of tolerance		Allowable tolerances depending on precision classes				
				P0	P6	P5	P4(SP)	P2(UP)
Dimensional accuracy	shaft	..		IT 6	IT 5	IT 4	IT 4	IT 3
	housing	..		IT 7	IT 6	IT 5	IT 5	IT 4
Roundness	shaft	○	t_1	IT 4	IT 3	IT 2	IT 1	IT 0
	housing			IT 5	IT 4	IT 3	IT 2	IT 1
Cylindricity	shaft	⊘	t_2	IT 3	IT 3	IT 2	IT 1	IT 0
	housing			IT 4	IT 3	IT 3	IT 2	IT 1
Runout	shaft	↗	t_3	IT 3	IT 3	IT 2	IT 1	IT 0
	housing			IT 4	IT 3	IT 2	IT 2	IT 1
Eccentricity	shaft	⊙	t_c	IT 5	IT 4	IT 4	IT 3	IT 3
	housing			IT 6	IT 5	IT 5	IT 4	IT 3



Shaft and housing fits

BASIC TOLERANCE RANGE ISO-IT

d; D		IT 0	IT 1	IT 2	IT 3	IT 4	IT 5	IT 6	IT 7	IT 8
from	to									
mm		μm								
1	3	0.5	0.8	1.2	2	2	4	6	10	14
3	6	0.6	1	1.5	2.5	4	5	8	12	18
6	10	0.6	1	1.5	2.5	4	6	9	15	22
10	18	0.8	1.2	2	3	5	8	11	18	27
18	30	1	1.5	2.5	4	6	9	13	21	33
30	50	1	1.5	2.5	4	7	11	16	25	39
50	80	1.2	2	3	5	8	13	19	30	46
80	120	1.5	2.5	4	6	10	15	22	35	54
120	180	2	3.5	5	8	12	18	25	40	63
180	250	3	4.5	7	10	14	20	28	46	72
250	315	4	6	8	12	16	23	32	52	81
315	400	5	7	9	13	18	25	36	57	89
400	500	6	8	10	15	20	27	40	63	97

DEVIATION OF SHAFT DIAMETERS 0,001 mm

Nominal diameter		g5		g6		h5		h6		h8		h10		j5	
over	inc	Max	Min	Max	Min	Max	Min	Max	Min	Max	Min	Max	Min	Max	Min
3	6	-4	-9	-4	-12	0	-5	0	-8	0	-18	0	-48	+3	-2
6	10	-5	-11	-5	-14	0	-6	0	-9	0	-22	0	-58	+4	-2
10	18	-6	-4	-6	-17	0	-8	0	-11	0	-27	0	-70	+5	-3
18	30	-7	-16	-7	-20	0	-9	0	-13	0	-33	0	-84	+5	-4
30	50	-9	-20	-9	-25	0	-11	0	-16	0	-39	0	-100	+6	-5
50	80	-10	-23	-10	-29	0	-13	0	-19	0	-46	0	-120	+6	-7
80	120	-12	-27	-12	-34	0	-15	0	-22	0	-54	0	-140	+6	-9
120	180	-14	-32	-14	-39	0	-18	0	-25	0	-63	0	-160	+7	-11
180	250	-15	-35	-15	-44	0	-20	0	-29	0	-72	0	-185	+7	-13
250	315	-17	-40	-17	-49	0	-23	0	-32	0	-81	0	-210	+7	-16
316	400	-18	-43	-18	-54	0	-25	0	-36	0	-89	0	-230	+7	-18
400	500	-20	-47	-20	-60	0	-27	0	-40	0	-97	0	-250	+7	-20

DEVIATION OF HOUSING DIAMETERS 0,001 mm

Nominal diameter		E8		G6		G7		H6		H7		H10		H11		J6	
over	inc	Max	Min	Max	Min	Max	Min	Max	Min	Max	Min	Max	Min	Max	Min	Max	Min
6	10	+47	+25	+14	+5	+20	+5	+9	0	+15	0	+58	0	+90	0	+5	-4
10	18	+59	+32	+17	+6	+24	+6	+11	0	+18	0	+70	0	+110	0	+6	-5
18	30	+73	+40	+20	+7	+28	+7	+13	0	+21	0	+84	0	+130	0	+8	-5
30	50	+89	+50	+25	+9	+34	+9	+16	0	+25	0	+100	0	+160	0	+10	-6
50	80	+106	+60	+29	+10	+40	+10	+19	0	+30	0	+120	0	+190	0	+13	-6
80	120	+126	+72	+34	+12	+47	+12	+22	0	+35	0	+140	0	+220	0	+16	-6
120	180	+148	+85	+39	+14	+54	+14	+25	0	+40	0	+160	0	+250	0	+18	-7
180	250	+172	+100	+44	+15	+61	+15	+29	0	+46	0	+185	0	+290	0	+22	-7
250	315	+191	+110	+49	+17	+69	+17	+32	0	+52	0	+210	0	+320	0	+25	-7
315	400	+214	+125	+54	+18	+75	+18	+36	0	+57	0	+230	0	+360	0	+29	-7
400	500	+232	+135	+60	+20	+83	+20	+40	0	+63	0	+250	0	+400	0	+33	-7

DEVIATION OF HOUSING DIAMETERS 0,001 mm

Nominal diameter		j6		k5		k6		m5		m6		n5		n6		p6	
over	inc	Max	Min	Max	Min	Max	Min	Max	Min	Max	Min	Max	Min	Max	Min	Max	Min
3	6	+6	-2	+6	+1	+9	+1	+9	+4	+12	+4	+13	+8	+16	+8	+20	+12
6	10	+7	-2	+7	+1	+10	+1	+12	+6	+15	+6	+16	+10	+19	+10	+24	+15
10	18	+8	-3	+9	+	+12	+1	+15	+7	+18	+7	+20	+12	+23	+12	+29	+18
18	30	+9	-4	+11	+2	+15	+2	+17	+8	+21	+8	+24	+15	+28	+15	+35	+22
30	50	+11	-5	+13	+2	+18	+2	+20	+9	+25	+9	+28	+17	+33	+17	+42	+26
50	80	+12	-7	+15	+2	+21	+2	+24	+11	+30	+11	+33	+20	+39	+20	+51	+32
80	120	+13	-9	+18	+3	+25	+3	+28	+13	+35	+13	+38	+23	+45	+23	+59	+37
120	180	+14	-11	+21	+3	+28	+3	+33	+15	+40	+15	+45	+27	+52	+27	+66	+43
180	250	+16	-13	+24	+4	+33	+4	+37	+17	+46	+17	+51	+31	+60	+31	+79	+50
250	315	+16	-16	+27	+4	+36	+4	+43	+20	+52	+20	+57	+34	+66	+34	+88	+56
315	400	+18	-18	+29	+4	+40	+4	+46	+21	+57	+21	+62	+37	+73	+37	+98	+62
400	500	+20	-20	+32	+5	+45	+5	+50	+23	+63	+23	+67	+40	+80	+40	+108	+68

Shaft and housing fits

DEVIATION OF SHAFT DIAMETERS 0,001 mm

Nominal diameter		j6		k5		k6		m5		m6		n5		n6		p6	
over	inc	Max	Min	Max	Min	Max	Min	Max	Min	Max	Min	Max	Min	Max	Min	Max	Min
3	6	+6	-2	+6	+1	+9	+1	+9	+4	+12	+4	+13	+8	+16	+8	+20	+12
6	10	+7	-2	+7	+1	+10	+1	+12	+6	+15	+6	+16	+10	+19	+10	+24	+15
10	18	+8	-3	+9	+	+12	+1	+15	+7	+18	+7	+20	+12	+23	+12	+29	+18
18	30	+9	-4	+11	+2	+15	+2	+17	+8	+21	+8	+24	+15	+28	+15	+35	+22
30	50	+11	-5	+13	+2	+18	+2	+20	+9	+25	+9	+28	+17	+33	+17	+42	+26
50	80	+12	-7	+15	+2	+21	+2	+24	+11	+30	+11	+33	+20	+39	+20	+51	+32
80	120	+13	-9	+18	+3	+25	+3	+28	+13	+35	+13	+38	+23	+45	+23	+59	+37
120	180	+14	-11	+21	+3	+28	+3	+33	+15	+40	+15	+45	+27	+52	+27	+66	+43
180	250	+16	-13	+24	+4	+33	+4	+37	+17	+46	+17	+51	+31	+60	+31	+79	+50
250	315	+16	-16	+27	+4	+36	+4	+43	+20	+52	+20	+57	+34	+66	+34	+88	+56
316	400	+18	-18	+29	+4	+40	+4	+46	+21	+57	+21	+62	+37	+73	+37	+98	+62
400	500	+20	-20	+32	+5	+45	+5	+50	+23	+63	+23	+67	+40	+80	+40	+108	+68

DEVIATION OF HOUSING DIAMETERS 0,001 mm

Nominal diameter		J7		K6		K7		M6		M7		N6		N7		P6		P5	
over	inc	Max	Min	Max	Min	Max	Min	Max	Min	Max	Min	Max	Min	Max	Min	Max	Min	Max	Min
6	10	+8	-7	+2	-7	+5	-10	-3	-12	0	-15	-7	-16	-4	-19	-12	-21	-9	-24
10	18	+10	-8	+2	-9	+6	-12	-4	-15	0	-18	-9	-20	-5	-23	-15	-26	-11	-29
18	30	+12	-9	+2	-11	+6	-15	-4	-17	0	-21	-11	-24	-7	-28	-18	-31	-14	-35
30	50	+14	-11	+3	-13	+7	-18	-4	-20	0	-25	-12	-28	-8	-33	-21	-37	-17	-42
50	80	+18	-12	+4	-15	+9	-21	-5	-24	0	-30	-14	-33	-9	-39	-26	-45	-21	-48
80	120	+22	-13	+4	-18	+10	-25	-6	-28	0	-35	-16	-38	-10	-45	-30	-52	-24	-59
120	180	+26	-14	+4	-21	+12	-28	-8	-33	0	-40	-20	-45	-12	-52	-36	-61	-28	-68
180	250	+30	-16	+5	-24	+13	-33	-8	-37	0	-46	-22	-51	-14	-60	-41	-70	-33	-79
250	315	+36	-16	+5	-27	+16	-36	-9	-41	0	-52	-25	-57	-14	-66	-47	-79	-36	-88
315	400	+39	-18	+7	-29	+17	-40	-10	-46	0	-57	-26	-62	-16	-73	-51	-87	-41	-98
400	500	+43	-20	+8	-32	+18	-45	-10	-50	0	-63	-27	-67	-17	-80	-55	-95	-45	-108

FITS

Tolerances for the boundary dimensions of bearings are to ISO standards. To ensure satisfactory performance of the bearing under variable operating conditions, it is necessary to select suitable fits between the inner ring and the shaft and the outer ring and the housing.

When selecting the correct fits from the ISO range of shaft and housing tolerances, it is necessary to consider adequate radial support of the bearing, ease of mounting and dismounting, and allowance for axial movement of the free bearing.

Selection of the fit also depends on the loading on the bearing and on the operating temperature. It should be noted that tight fits reduce the internal clearance of the bearing, and allowance should be made when selecting the bearing clearance.

TOLERANCES

The boundary dimensions and tolerances of rolling bearings have been standardized by ISO. Bearings are manufactured to normal class 0 tolerances, unless otherwise stated.

Tolerances are also listed for the closer-than-normal limits required, for example, in machine tool and high speed applications.

The more common ISO norms referred to are as follows:

ISO 15-2011	Rolling bearings – Radial bearings – Boundary dimensions
ISO 104-2002	Thrust bearings with flat housing washers – Boundary dimensions
ISO 199-2005	Rolling bearings – Thrust ball bearings – Tolerances
ISO 355-2007	Metric tapered roller bearing - Boundary dimensions
ISO 464-2002	Rolling bearings with locating snap ring – Dimensions
ISO 492-2002	Radial bearings – Tolerances
ISO 1132-2001	Rolling bearings – Tolerances – Definitions
ISO 5753-2009	Rolling bearings – Radial internal clearances



Shaft and housing fits

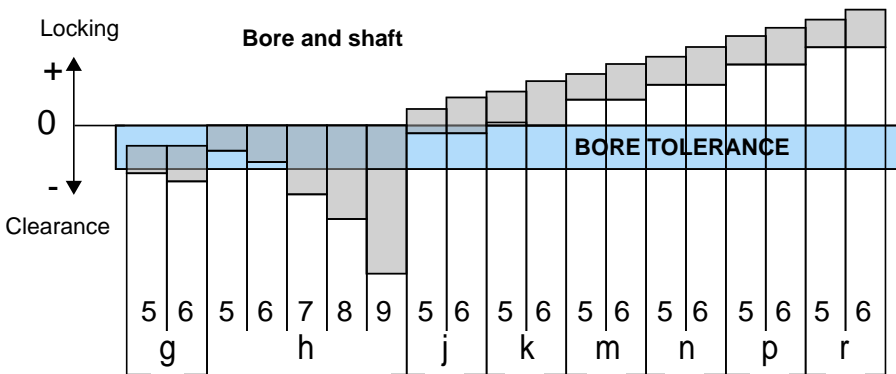
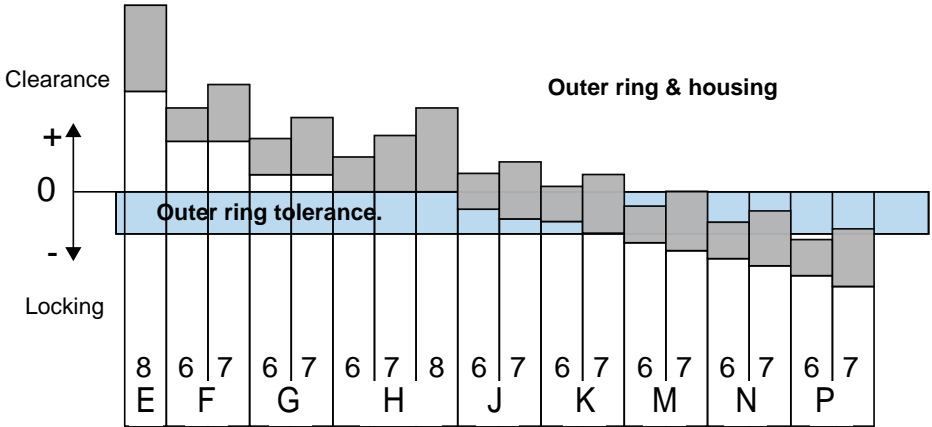

INTRODUCTION

The dimensional and running accuracies of our bearings are standardized according to ISO.

BORE DIAMETER

d	Nominal bore diameter
$d1$	Nominal large diameter of tapered bore
d_s	Single bore diameter
Δd_s	Deviation of a single bore diameter
v_{ds}	Bore diameter variation
D_m	Mean bore diameter
Δd_m	Mean bore diameter deviation
D_{mp}	Single plane mean bore diameter
Δd_{mp}	Single plane mean bore diameter deviation
Δd_{1mp}	Deviation of mean large diameter from nominal-tapered bore
V_{DP}	Bore diameter variation in a single radial plane
V_{DMP}	Mean bore diameter variation
α	Taper angle

OUTSIDE DIAMETER

D	Nominal outside diameter
D_s	Single outside diameter
v_{Ds}	Deviation of a single outside diameter
D_m	Mean outside diameter
ΔD_m	Mean outside diameter deviation
D_{mp}	Single plane mean outside diameter
ΔD_{mp}	Single plane outside diameter deviation
V_{DP}	Outside diameter variation in a single radial plane
V_{DMP}	Mean outside diameter variation



Tolerances

ROLLING BEARING TOLERANCE SYMBOL

OUTSIDE DIAMETER

B	Nominal inner ring width
V	Nominal outer ring width
Bs	Single inner ring width
Cs	Single outer ring width
ΔB_s	Deviation of a single inner ring width
ΔC_s	Deviation of a single outer ring width
$\sqrt{B_s}$	inner ring width variation
$\sqrt{C_s}$	Outer ring width variation
Bm	Mean inner ring width

RADIAL RUN OUT

Kla	Radial run out of assembled bearing inner ring
Kea	Radial run out of assembled bearing outer ring
Sd	Face run out with bore
SD	Variation of outside surface inclination with face
Sl _a	Assembled bearing inner ring face run out with raceway
Se _a	Assembled bearing outer ring face run out with raceway
D1	Nominal diameter of outer ring flange
T	Nominal width of tapered roller bearing
ΔT_s	Deviation in width of tapered roller bearing at single position
T1	Nominal width of tapered roller bearing-cone
ΔT_{1s}	Deviation of width of tapered roller bearing-cone
T2	Nominal width of tapered roller bearing-cup
ΔT_{2s}	Deviation of width of tapered roller bearing-cup
d2	Nominal shaft washer diameter – double acting thrust bearing
Δd_{2p}	Deviation of shaft washer mean bore diameter single plane
Dw	Nominal diameter of roller
Dwm	Mean diameter of roller
Lw	Nominal length of roller

PRECISION CLASS P0 - INNER RING

d mm		Δd_{mp}		V_{dp} Diameter ranges			V_{dmp}	K_{ia}	ΔB_s				V_{Bs}
				7,8,9	0,1	2,3,4			Modified ²⁾				
over	up to	upper	lower	max.			max.	max.	upper	lower	upper	lower	max.
0,6 ¹⁾	2,5	0	-8	10	8	6	6	10	0	-40	-	-	12
2,5	10	0	-8	10	8	6	6	10	0	-120	0	-250	15
10	18	0	-8	10	8	6	6	10	0	-120	0	-250	20
18	30	0	-10	13	10	8	8	13	0	-120	0	-250	20
30	50	0	-12	15	12	9	9	15	0	-120	0	-250	20
50	80	0	-15	19	19	11	11	20	0	-150	0	-380	25
80	120	0	-20	25	25	15	15	25	0	-200	0	-380	25
120	180	0	-25	31	31	19	19	30	0	-250	0	-500	30
180	250	0	-30	38	38	23	23	40	0	-300	0	-500	30
250	315	0	-35	44	44	26	26	50	0	-350	0	-500	35
315	400	0	-40	50	50	30	30	60	0	-400	0	-500	40
400	500	0	-45	56	56	34	34	65	0	-450	0	-630	50
500	630	0	-50	63	63	38	38	70	0	-500	-	-	60
630	800	0	-75	-	-	-	-	80	0	-750	-	-	70
800	1000	0	-100	-	-	-	-	90	0	-1000	-	-	80
1000	1250	0	-125	-	-	-	-	100	0	-1250	-	-	100
1250	1600	0	-160	-	-	-	-	120	0	-1600	-	-	120
1600	2000	0	-200	-	-	-	-	140	0	-2000	-	-	140
-	-	-	-	-	-	-	-	-	-	-	-	-	-

Tolerances in μm

- 1) Including this dimension
- 2) Only for bearings mounted in sets



Tolerances

PRECISION CLASS RADIAL BEARING - METRIC SIZE - PRECISION CLASS P0

OUTER RING

D mm		ΔDmp		V _{dp2} Open Bearings Diameter ranges			Sealed bearings	V _{dmp2}	K _{ea}	ΔCs	VCs
				7,8,9	0,1	2,3,4	2,3,4				
over	up to	upper	lower	max.			max.	max.	max.		
2,5 ¹⁾	6	0	-8	10	8	6	10	6	10	Identical with ΔBs and VBs of the inner ring of the same bearing	
6	18	0	-8	10	8	6	10	6	10		
18	30	0	-9	12	9	7	12	6	10		
30	50	0	-11	14	11	8	16	8	13		
50	80	0	-13	16	13	10	20	9	15		
80	120	0	-15	19	19	11	26	11	20		
120	150	0	-18	23	23	14	30	15	25		
150	180	0	-25	31	31	19	38	19	30		
180	250	0	-30	38	38	23	-	23	40		
250	315	0	-35	44	44	26	-	26	50		
315	400	0	-40	50	50	30	-	30	60		
400	500	0	-45	56	56	34	-	34	65		
500	630	0	-50	63	63	38	-	38	70		
630	800	0	-75	94	94	55	-	-	80		
800	1000	0	-100	125	125	75	-	-	90		
1000	1250	0	-125	-	-	-	-	-	100		
1250	1600	0	-160	-	-	-	-	-	120		
1600	2000	0	-200	-	-	-	-	-			
2000	2500	0	-250	-	-	-	-	-	140		

Tolerances in μm

- 1) Including this dimension
- 2) Main diameter variation before fitting snap rings

PRECISION CLASS RADIAL BEARINGS WITH TAPERED BORE

Precision class P0

Tolerances in μm

d mm		$\Delta d_{mp}^{1)}$		$\Delta d_{1mp} - \Delta d_{mp}^{2)}$		$\sqrt{dp}^{3)}$
over	to	upper	lower	upper	lower	max.
-	10	+15	0	+15	0	10
10	18	+18	0	+18	0	10
18	30	+21	0	+21	0	13
30	50	+25	0	+25	0	15
50	80	+30	0	+30	0	19
80	120	+35	0	+35	0	25
120	180	+40	0	+40	0	31
180	250	+46	0	+46	0	38
250	315	+52	0	+52	0	44
315	400	+57	0	+57	0	50
400	500	+63	0	+63	0	56

- 1) Single plane main bore diameter deviation at smallest theoretical opening
- 2) Main diameter deviation of large diameter less main diameter deviation from smaller diameter
- 3) Bore diameter variation in a single radial plane

Tolerances For Tapered Bores – Taper 1:12

Nominal dimensions

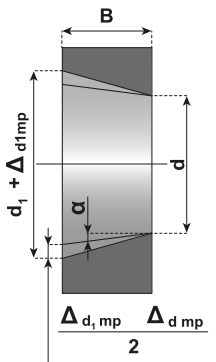

$$\alpha = 2^\circ 23' 9,4'' = 2.38594^\circ = 0.041643 \text{ rad}$$

half the angle of taper

Tolerances

PRECISION CLASS RADIAL BEARINGS - METRIC SIZE - PRECISION CLASS P6

PRECISION CLASS P6 - INNER RING

d mm		Δd_{mp}		V_{dp} Diameter ranges			V_{dmp}	K_{ia}	ΔB_s				V_{Bs}
				7,8,9	0,1	2,3,4			Modified ²⁾				
over	up to	upper	lower	max.			max.	max.	upper	lower	upper	lower	max.
0,6¹⁾	2,5	0	-7	9	7	5	5	5	0	-40	-	-	12
2,5	10	0	-7	9	7	5	5	6	0	-120	0	-250	15
10	18	0	-7	9	7	5	5	7	0	-120	0	-250	20
18	30	0	-8	10	8	6	6	8	0	-120	0	-250	20
30	50	0	-10	13	10	8	8	10	0	-120	0	-250	20
50	80	0	-12	15	15	9	9	10	0	-150	0	-380	25
80	120	0	-15	19	19	11	11	13	0	-200	0	-380	25
120	180	0	-18	23	23	14	14	18	0	-250	0	-500	30
180	250	0	-22	28	28	17	17	20	0	-300	0	-500	30
250	315	0	-25	31	31	19	19	25	0	-350	0	-500	35
315	400	0	-30	38	38	23	23	30	0	-400	0	-630	40
400	500	0	-35	44	44	26	26	35	0	-450	-	-	50
500	630	0	-40	50	50	30	30	40	0	-500	-	-	60

1) Including this dimension

2) Only for bearings mounted in sets
Tolerances in μm

OUTER RING

D mm		$\Delta D_m p$		VDp ²⁾ Open Bearings Diameter ranges			Sealed bearings	VDmp ²⁾	K _{oa}	ΔC_s	VCs
				7,8,9,	0,1	2,3,4	2,3,4				
over	up to	upper	lower	max.			max.	max.	max.		
2,5 ¹⁾	6	0	-7	9	7	5	9	5	8	Identical with ΔB_s and VBs of the inner ring of the same bearing	
6	18	0	-7	9	7	5	9	5	8		
18	30	0	-8	10	8	6	10	6	9		
30	50	0	-9	11	9	7	13	7	10		
50	80	0	-11	14	11	8	16	8	13		
80	120	0	-13	16	16	10	20	10	18		
120	150	0	-15	19	19	11	25	11	20		
150	180	0	-18	23	23	14	30	14	23		
180	250	0	-20	25	25	15	-	15	25		
250	315	0	-25	31	31	19	-	19	30		
315	400	0	-28	35	35	21	-	21	35		
400	500	0	-33	41	41	25	-	25	40		
500	630	0	-38	48	48	29	-	29	50		
630	800	0	-45	56	56	34	-	34	60		
800	1000	0	-60	75	75	45	-	45	75		

Tolerances in μm



Tolerances

PRECISION CLASS RADIAL BEARINGS - METRIC SIZE - PRECISION CLASS P5

PRECISION CLASS P5 - INNER RING

d mm		cylindrical bore			Δd_s		tapered bore				ΔB_s	Bs	K_{ia}	Sd	Sia
		$\Delta d_{mp}, \Delta d_s \vee d_p$					$V_{dp} \Delta d_{1mp} - \Delta d_{mp}$								
from	to	lower	upper	max.	lower	upper	max.	lower	upper	lower	upper	max.	max.	max.	max.
18	30	-6	0	3	0	+10	3	0	+4	-100	0	5	3	8	8
30	50	-8	0	4	0	+12	4	0	+6	-120	0	5	4	8	8
50	80	-9	0	5	0	+15	5	0	+6	-150	0	6	4	8	8
80	120	-10	0	5	0	+20	5	0	+8	-200	0	7	5	9	9
120	180	-13	0	7	0	+25	7	0	+8	-250	0	8	6	10	10
180	250	-15	0	8	0	+30	8	0	+10	-300	0	10	8	11	13
250	315	-15	0	9	0	+35	9	0	+12	-350	0	13	8	13	15
315	400	-23	0	12	0	+40	12	0	+12	-400	0	15	10	15	20
400	500	-27	0	14	0	+45	14	0	+14	-400	0	17	10	17	23

Tolerances in μm

PRECISION CLASS P5 - OUTER RING

D mm		$\Delta D_{mp}, \Delta D_s$		V_{dp}	K_{ea}	SD	Sea
from	to	lower	upper	max.	max.	max.	max.
30	50	-7	0	4	5	8	8
50	80	-9	0	5	5	8	10
80	120	-10	0	5	6	9	11
120	150	-11	0	6	7	10	13
150	180	-13	0	7	8	10	14
180	250	-15	0	8	10	11	15
250	315	-18	0	9	11	13	18
315	400	-20	0	10	13	13	20
400	500	-23	0	12	15	15	23
500	630	-28	0	14	17	18	25
630	800	-35	0	18	20	20	30

Tolerances in μm

PRECISION CLASS P4 - INNER RING

d mm		cylindrical bore			Δds		tapered bore				ΔBs	\sqrt{Bs}	K_{ia}	Sd	Sia
		$\Delta dmp, \Delta ds V_{dp}$					$V_{dp} \Delta d1mp - \Delta dmp$								
from	to	lower	upper	max.	lower	upper	max.	lower	upper	lower	upper	max.	max.	max.	max.
18	30	-5	0	2.5	0	+6	2.5	0	+2	-25	0	1.5	1.5	3	3
30	50	-6	0	3	0	+7	3	0	+3	-30	0	2	2	3	3
50	80	-7	0	3.5	0	+8	3.5	0	+3	-40	0	3	2	4	3
80	120	-8	0	4	0	+10	4	0	+4	-50	0	3	3	4	4
120	180	-10	0	5	0	+12	5	0	+4	-60	0	4	3	5	6
180	250	-12	0	6	0	+14	6	0	+5	-75	0	5	4	6	7
250	315	-15	0	8	0	+15	8	0	+6	-100	0	5	4	6	8
315	400	-19	0	10	0	+17	10	0	+6	-100	0	6	5	7	9
400	500	-23	0	12	0	+19	12	0	+7	-100	0	7	5	8	10

Tolerances in μm

PRECISION CLASS UP - OUTER RING

D mm		$\Delta Dmp, \Delta Ds$		V_{dp}	K_{ea}	SD	Sea
from	to	lower	upper	max.	max.	max.	max.
30	50	-5	0	3	3	2	4
50	80	-6	0	3	3	2	4
80	120	-7	0	4	3	3	5
120	150	-8	0	4	4	3	6
150	180	-9	0	5	4	3	7
180	250	-10	0	5	5	4	9
250	315	-12	0	6	6	4	9
315	400	-14	0	7	7	5	12
400	500	-17	0	9	8	5	12
500	630	-20	0	10	9	6	14
630	800	-25	0	13	11	7	17

Tolerances in μm

Tolerances

PRECISION CLASS TAPERED ROLLER BEARING - METRIC SIZE - PRECISION CLASS P0

PRECISION CLASS P0 - INNER RING

d mm		ΔD_{mp}		\sqrt{dp}	\sqrt{dmp}	K_{ia}
over	up to	upper	lower	max.	max.	max.
10	18	0	-12	12	9	15
18	30	0	-12	12	9	18
30	50	0	-12	12	9	20
50	80	0	-15	15	11	25
80	120	0	-20	20	15	30
120	180	0	-25	25	19	35
180	250	0	-30	30	23	50
250	315	0	-35	35	26	60
315	400	0	-40	40	30	70

Tolerances in μm

OUTER RING

D mm		ΔD_{mp}		\sqrt{Dp}	\sqrt{Dmp}	K_{ea}
over	up to	upper	lower	max.	max.	max.
18	30	0	-12	12	9	18
30	50	0	-14	14	11	20
50	80	0	-16	16	12	25
80	120	0	-18	18	14	35
120	150	0	-20	20	15	40
150	180	0	-25	25	19	45
180	250	0	-30	30	23	50
250	315	0	-35	35	26	60
315	400	0	-40	40	30	70
400	500	0	-45	45	34	80
500	630	0	-50	50	38	100

Tolerances in μm

Note: the limit tolerance of the outer diameter D1 of a flanged bearing is h9

PRECISION CLASS P0 - WITH OF INNER, OUTER RING AND HEIGHT

d mm		$\Delta BS, \Delta CS$		ΔTS		$\Delta T1S$		$\Delta T2S$	
over	up to	upper	lower	upper	lower	upper	lower	upper	lower
10	18	0	-120	+120	0	+100	0	+100	0
18	30	0	-120	+200	0	+100	0	+100	0
30	50	0	-120	+200	0	+100	0	+100	0
50	80	0	-150	+200	0	+100	0	+100	0
80	120	0	-200	+200	-200	+100	-100	+100	-100
120	180	0	-250	+350	-250	+150	-150	+200	-100
180	250	0	-300	+350	-250	+150	-150	+200	-100
250	315	0	-350	+350	-250	+150	-150	+200	-100
315	400	0	-400	+400	-400	+200	-200	+200	-200

Tolerances in μm

PRECISION CLASS P6X

D mm		ΔBs		ΔCs		ΔTs		$\Delta T1s$		$\Delta T2s$	
over	up to	upper	lower	upper	lower	upper	lower	upper	lower	upper	lower
10	18	0	-50	0	-100	+100	0	+50	0	+50	0
18	30	0	-50	0	-100	+100	0	+50	0	+50	0
30	50	0	-50	0	-100	+100	0	+50	0	+50	0
50	80	0	-50	0	-100	+100	0	+50	0	+50	0
80	120	0	-50	0	-100	+100	0	+50	0	+50	0
120	180	0	-50	0	-100	+150	0	+50	0	+100	0
180	250	0	-50	0	-100	+150	0	+50	0	+100	0
250	315	0	-50	0	-100	+200	0	+100	0	+100	0
315	400	0	-50	0	-100	+200	0	+100	0	+100	0

Tolerances in μm

The limit tolerances for The diameter and The radial run-out of The outer ring and The inner ring in this precision class are The same with precision class P0.

The limit tolerances for the width and mounting height for the outer and inner ring are those indicated below.

Tolerances

PRECISION CLASS TAPERED ROLLER BEARINGS - METRIC SIZE - PRECISION CLASS P4

PRECISION CLASS P5 - INNER RING

d mm		Δd_{mp}		V_{dp}	VD_{MP}	K_{ia}	S_d	ΔB_s		ΔT_s	
over	up to	upper	lower	max.	max.	max.	max.	upper	lower	upper	lower
10	18	0	-7	5	5	5	7	0	-200	+200	-200
18	30	0	-8	6	5	5	8	0	-200	+200	-200
30	50	0	-10	8	5	6	8	0	-240	+200	-200
50	80	0	-12	9	6	7	8	0	-300	+200	-200
80	120	0	-15	11	8	8	9	0	-400	+200	-200
120	180	0	-18	14	9	11	10	0	-500	+350	-250
180	250	0	-22	17	11	13	11	0	-600	+350	-250

Tolerances in μm

OUTER RING

D mm		ΔD_{mp}		V_{dp}	VD_{MP}	K_{ea}	SD	ΔC_s
over	up to	upper	lower	max.	max.	max.	max.	
18	30	0	-8	6	5	6	8	Identical with ΔB_s of the inner ring of the same bearing
30	50	0	-9	7	5	7	8	
50	80	0	-11	8	6	8	8	
80	120	0	-13	10	7	10	9	
120	150	0	-15	11	8	11	10	
150	180	0	-18	14	9	13	10	
180	250	0	-20	15	10	15	11	
250	315	0	-25	19	13	18	13	
315	400	0	-28	22	14	20	13	

Tolerances in μm

The limit tolerance of the outer diameter D_1 of a flanged bearing is h9.

PRECISION CLASS P4 - INNER RING

d mm		$\Delta d_{mp}, ds$		V_{dp}	VD_{MP}	K_{ia}	Sd	Sia	ΔBs		ΔTs	
over	up to	upper	lower	max.	max.	max.	max.	max.	upper	lower	upper	lower
10	18	0	-5	4	4	3	3	3	0	-200	+200	-200
18	30	0	-6	5	4	3	4	4	0	-200	+200	-200
30	50	0	-8	6	5	4	4	4	0	-240	+200	-200
50	80	0	-9	7	5	4	4	4	0	-300	+200	-200
80	120	0	-10	8	5	5	5	5	0	-400	+200	-200
120	180	0	-13	10	7	6	7	7	0	-500	+350	-250
180	250	0	-15	11	8	8	8	8	0	-600	+350	-250

Tolerances in μm

OUTER RING

D mm		$\Delta D_{mp}, \Delta Ds$		V_{dp}	VD_{MP}	K_{ea}	SD	Sea	ΔCs
over	up to	upper	lower	max.	max.	max.	mas.	max.	Upper / lower
18	30	0	-6	5	4	4	4	5	Identical with ΔBs of the inner ring of the same bearing
30	50	0	-7	5	5	5	4	5	
50	80	0	-9	7	5	5	4	5	
80	120	0	-10	8	5	6	5	6	
120	150	0	-11	8	6	7	5	7	
150	180	0	-13	10	7	8	5	8	
180	250	0	-15	11	8	10	7	10	
250	315	0	-18	14	9	11	8	10	
315	400	0	-20	15	10	13	10	13	

Tolerances in μm

Tolerances

PRECISION CLASS TAPERED ROLLER BEARINGS - INCH SIZE – PRECISION ACCORDING AFBMA STANDARD

INNER RING

d mm		Precision classes									
		4		2		3		0		00	
over	up to	upper	lower	upper	lower	upper	lower	upper	lower	upper	lower
-	76.2	+13	0	+13	0	+13	0	+13	0	+8	0
76.2	304.2	+25	0	+25	0	+13	0	+13	0	+8	0
304.2	609.6	+51	0	+51	0	+25	0	-	-	-	-
609.6	914.4	+76	0	-	-	+38	0	-	-	-	-
914.4	1219.2	+102	0	-	-	+51	0	-	-	-	-
1219.2	-	+127	0	-	-	+76	0	-	-	-	-

Tolerances in μm

OUTER RING

D mm		Precision classes									
		4		2		3		0		00	
over	up to	upper	lower	upper	lower	upper	lower	upper	lower	upper	lower
-	304.8	+25	0	+25	0	+13	0	+13	0	+8	0
304.8	609.6	+51	0	+51	0	+25	0	-	-	-	-
609.6	912.4	+76	0	+76	0	+38	0	-	-	-	-
914.4	1219.2	+102	0	-	-	+51	0	-	-	-	-
1219.2	-	+127	0	-	-	+76	0	-	-	-	-
-	-	-	-	-	-	-	-	-	-	-	-

Tolerances in μm

TOLERANCES FOR THE MOUNTING HEIGHT ON THE INNER RING ROLLER SUB-ASSEMBLY WITH OUTER RING ($\Delta T1S$)

d mm		D mm		Precision classes									
				4		2		3		0		00	
over	up to	over	up to	upper	lower	upper	lower	upper	lower	upper	lower	upper	lower
-	101.6			+102	0	+102	0	+102	-102	+102	-102	+102	-102
101.6	304.8			+152	-152	+102	0	+102	-102	+102	-102	+102	-102
304.8	609.6		508.0	+178	-178	+178	-178	+102	-102	-	-	-	-
304.8	609.6	508.0	-	+178	-178	+178	-178	+178	-178	-	-	-	-
609.6	-			+178	-178	-	-	+178	-178	-	-	-	-

Tolerances in μm

RADIAL RUN-OUT OF AN ASSEMBLED BEARINGS

d mm		Precision classes				
		4	2	3	0	00
over	up to	max.	max.	max.	max.	max.
-	304.8	51	38	8	4	2
304.8	609.6	51	38	18	-	-
609.6	914.4	76	51	51	-	-
914.4	-	76	-	76	-	-

Tolerances in μm

TOLERANCES FOR MOUNTING HEIGHT ΔT_s

d mm		D mm		Precision classes									
				4		2		3		0		00	
over	up to	over	up to	upper	lower	upper	lower	upper	lower	upper	lower	upper	lower
-	101.6			+203	0	+203	0	+203	-203	+203	-203	+203	-203
101.6	304.8			+356	-254	+203	0	+203	-203	+203	-203	+203	-203
304.8	609.6	-	508.0	+318	-381	+381	-381	+203	-203	-	-	-	-
304.8	609.6	508.0		+318	-381	+318	-381	+381	-381	-	-	-	-
609.6	-			+318	-381	-	-	+381	-381	-	-	-	-

Tolerances in μm

TOLERANCES FOR THE MOUNTING HEIGHT ON THE INNER RING ROLLER SUB-ASSEMBLY WITH OUTER RING (ΔT_{2S})

d mm		D mm		Precision classes									
				4		2		3		0		00	
over	up to	over	up to	upper	lower	upper	lower	upper	lower	upper	lower	upper	lower
-	101.6			+102	0	+102	0	+102	-102	+102	-102	+102	-102
101.6	304.8			+203	-102	+102	0	+102	-102	+102	-102	+102	-102
304.8	609.6		508.0	+203	-203	+203	-203	+102	-102	-	-	-	-
304.8	609.6	508.0	-	+203	-203	+203	-203	+203	-203	-	-	-	-
609.6	-			+203	-203	-	-	+203	-203	-	-	-	-

Tolerances in μm

Tolerances

PRECISION CLASS THRUST BEARING

SINGLE ACTING THRUST BEARING (SINGLE ROW)

SHAFT WASHER

d mm		P0; P6 ; P5			P4; P2		
		Δd_{mp} Δd_{2mp}		V_{dp} VD_{2P}	Δd_{mp} Δd_{2mp}		V_{dp} VD_{2P}
over	up to	upper	lower	max.	upper	lower	max.
-	18	0	-8	6	0	-7	5
18	30	0	-10	8	0	-8	6
30	50	0	-12	9	0	-10	8
50	80	0	-15	11	0	-12	9
80	120	0	-20	15	0	-15	11
120	180	0	-25	19	0	-18	14
180	250	0	-30	23	0	-22	17
250	315	0	-35	26	0	-25	19
315	400	0	-40	30	0	-30	23
400	500	0	-45	34	0	-35	26
500	630	0	-50	38	0	-40	30
630	800	0	-75	-	0	-50	-
800	1000	0	-100	-	-	-	-
1000	1250	0	-125	-	-	-	-

Tolerances in μm

HOUSING WASHER

d mm		P0; P6 ; P5			P4; P2		
		VD_{MP}		V_{dp}	Δd_{mp}		V_{dp}
over	up to	upper	lower	max.	upper	lower	max.
10	18	0	-11	8	0	-7	5
18	30	0	-13	10	0	-8	6
30	50	0	-16	12	0	-9	7
50	80	0	-19	14	0	-11	8
80	120	0	-22	17	0	-13	10
120	180	0	-25	19	0	-15	11
180	250	0	-30	23	0	-20	15
250	315	0	-35	26	0	-25	19
315	400	0	-40	30	0	-28	21
400	500	0	-45	34	0	-33	25
500	630	0	-50	38	0	-38	29
630	800	0	-75	55	0	-45	34
800	1000	0	-100	75	0	-	-
1000	1250	0	-125	-	0	-	-
1250	1600	0	-160	-	0	-	-

Tolerances in μm

DOUBLE ACTING THRUST BEARING (DOUBLE ROW)

PRECISION CLASS P5 AND P6 - INNER RING

d mm		P5					P6			P5 and P6			
		Δdmp		Δds		Sia	Δds		Sia	Hs		Cs	
over	up to	upper	lower	upper	lower	max.	upper	lower	max.	upper	lower	upper	lower
16	18	0	-7	+1	-8	3	0	-5	1.5	+50	-80	0	-30
18	30	0	-8	+1	-9	3	0	-6	1.5	+50	-80	0	-30
30	50	0	-10	+1	-11	3	0	-8	1.5	+60	-100	0	-30
50	80	0	-12	+2	-14	4	0	-9	2	+70	-120	0	-30
80	120	0	-15	+3	-18	4	0	-10	2	+85	-140	0	-30
120	180	0	-18	+3	-21	5	0	-13	3	+95	-160	0	-30
180	250	0	-22	+4	-26	5	0	-15	3	+120	-200	0	-30

PRECISION CLASS P5 AND P6 - OUTER RING

D mm		SP and UP		
		ΔDS	Sea	
over	up to	upper	lower	max.
30	50	-20	-27	Identical with the inner ring of the same bearing
50	80	-24	-33	
80	120	-28	-38	
120	150	-33	-44	
150	180	-33	-46	
180	250	-37	-52	
250	315	-41	-59	

SINGLE & DOUBLE ACTING THRUST BEARING

d mm		Si					Se
		P0;	P6;	P5;	P4;	P2	P0; P6; P5; P4; P2
over	up to	max.	max.	max.	max.	max.	
-	18	10	5	3	2	1	Identical with S1 of the shaft washer
18	30	10	5	3	2	1.2	
30	50	10	6	3	2	1.5	
50	80	10	7	4	3	2	
80	120	15	8	4	3	2	
120	180	15	9	5	4	3	
180	250	20	10	5	4	3	
250	315	25	13	7	5	4	
315	400	30	15	7	5	4	
400	500	30	18	9	6	-	
500	630	35	21	11	7	-	
630	800	40	25	13	8	-	
800	1000	45	30	15	-	-	
1000	1250	50	35	18	-	-	

Tolerances in μm

GENERAL GUIDELINES, ROLLING BEARING LUBRICATION

The main duties of introducing lubricants into ball and roller bearings, apart from protecting the finely finished surfaces when rotating at high speeds, is to reduce friction between the rolling elements, the separator or cage, and the races at any point where true rolling is absent. Lubrication also assists in dissipating heat, and sealing the bearing against the entry of contaminants such as dust and moisture.

Rolling bearings may be lubricated with oil or grease. The choice of lubricant is usually decided by temperature, speed, load, and operating conditions along with bearing design. We summarize as follows:

SIZE OF BEARING

The size of bearing governs the viscosity of the lubricant – the larger the bearing the higher should be the viscosity. Regarding size, rolling bearings can be divided into four sizes depending on the outside diameter:

Very small bearings	$D \leq 22 \text{ mm}$
Small bearings	$D \leq 62 \text{ mm}$
Medium bearings	$62 \leq D \leq 240 \text{ mm}$
Large bearings	$D \geq 240 \text{ mm}$

1. SPEED

Speed has an influence upon the viscosity of the lubricant because the resisting force, opposed to the moving parts by the lubricant, depends on its viscosity. The higher the revolution speed, the lower the viscosity of the lubricant should be.

The revolution speed may be:

Normal $n \leq 75\%$ of the limit speed specified in the tables

High $75\% \leq 100\%$ of the limit speed specified in the tables

Very high $n \geq 100\%$ of the limit speed specified in the tables. For very high revolution speeds, oil lubrication is required to transfer frictional heat or other sources of heat away from the bearing.

2. LOAD

Equivalent loading capacity, $P = XFr + YFa$, conditions the viscosity grade of the lubricant, due to specific pressure which appears between the contact surfaces. The higher this is, the greater the resistance of the lubricant film should be, and the respective viscosity. Loads may vary as follows:

normal loads where

$P/Cr \leq 0.1$ for bearings within diameter ranges 1, 2 and 3.

$P/Cr \leq 0.15$ for bearings within diameter range 4.

high loads where

$P/Cr \geq 0.1$ for bearings within diameter ranges 1, 2 and 3.

$P/Cr \geq 0.15$ for bearings within diameter range 4.

P = equivalent dynamic load [kN]

Cr = basic dynamic load [kN]

3. TEMPERATURE

The operating temperature affects selection of lubricants, as it is an influence upon viscosity. Therefore, each lubricant is used only

within the limits of certain clearly defined temperature ranges.



Lubrication

GREASE & OIL LUBRICATION

Although oil is the better lubricant, grease is often preferred because of the following natural advantages:

Grease helps to form an effective closure between the shaft and housing, thus preventing the ingress of dirt, moisture and other corrosive agents.

Grease protects the finely finished working surfaces of a bearing by clinging to them, particularly when the bearing is not in motion. Oil tends to drain away, leaving the surfaces open to attack.

Grease is easier to retain within the housing than oil. This is of great help in the food, printing, textile, chemical and other industries where contamination or staining can ruin the product.

Grease is convenient to handle, and re-lubrication of bearings is quick and clean. Planned lubrication cycles are often possible, resulting in smaller labour costs.

Whatever type of grease is used, it should have no tendency to separate under operating conditions. When separation occurs, the oil runs out of the bearing and leaves behind dry soap, which hardens and cakes. This interferes with the movement of the rolling element, which may result in overheating and mechanical failure. Excessive softening is also undesirable, because the grease might then leak out of the bearing and leave working surfaces unprotected.

The quantity of grease used for the lubrication of a rolling bearing should not be too great, as a tightly packed bearing is liable to overheat if operated at high speed. Relubrication intervals depend on the bearing type, inner diameter and revolution speed for filling with fresh grease. The quantity required is given in the following equation:

$$G = 0.005 \text{ DB grams}$$

where:

D = outer diameter (m/m)

B = width (m/m)

After a certain number of refills, it is necessary to remove old grease completely using a suitable solvent. Never mix two grades of grease.

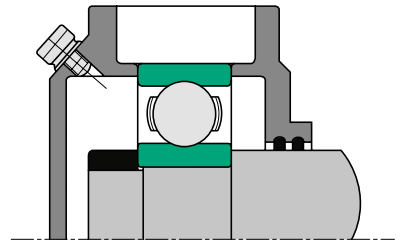

Typical Grease Lubrication

OIL LUBRICATION

Oil is sometimes more convenient to use than grease, and there are circumstances when it is definitely preferred. These are as follows:

When frictional resistance in light machinery and instruments must be kept low.

Where either the speed or the temperature is too high for grease lubrication.

Where high temperature and heavy load occur together, with or without high speed.

Where the bearings are enclosed in a casing that contains other components lubricated by oil, e.g. a gearbox.

A good quality mineral oil should be used of a viscosity to suit the operating conditions involved.

Vegetable or animal oils are not recommended as these can become rancid under certain conditions and cause corrosion problems. A small supply of oil is required to lubricate the bearings; a more copious supply should be used if the bearing must be kept cool, when it is often advantageous to use a synthetic oil to cope with the temperature conditions. Limiting temperature for mineral oil is about 150°C (302°F) and for synthetic oils about 220°C (428°F).

OIL BATH

This method is suitable for horizontal shaft applications. The oil should reach the center of the bottom ball or roller in the bearing; a greater depth than this could cause overheating due to churning of the oil. The surface area and volume of the oil in the bath should be sufficiently large to maintain an adequate depth of oil for the cage to dip into when running. Sight oil level indicators can be used. Alternatively, a tapped and plugged hole can be provided at the correct level; when replenishing the oil, the plug is removed and oil added until it starts to escape through the hole. The plug should, of course, be replaced before the machine is started!

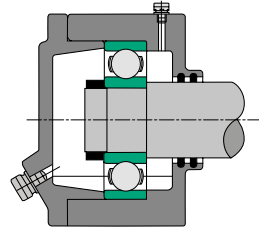

PUMP-FEED LUBRICATION

This is especially suitable for heavily loaded, high-speed bearings, since such conditions can result in bearing temperatures well in excess of 100°C (212°F). Oil is pump-fed to each bearing, being directed by jets on to the outside diameter of the inner ring so that some of it gains access to the internal parts of the bearing. Each bearing may require from 45 to 140 litres of oil per hour, although most of this only flushes the face of the bearing to keep it cool. A reservoir is often provided to lubricate the bearing during starting; alternatively, the pump can be started before the machine is set in motion so that the bearing never runs unlubricated.

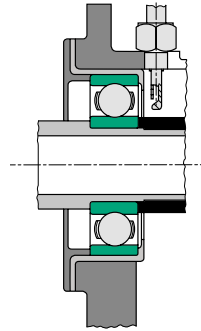

SPLASH LUBRICATION

This is suitable when the bearings are enclosed in a casing, such as a gearbox, and the oil used to lubricate the gears is distributed sufficiently to lubricate the bearings. The oil is either splashed directly on to the bearings or collected in galleries and directed to the bearings. The drawing below illustrates how the oil is made to pass through the bearing before it returns to the gearbox casing.

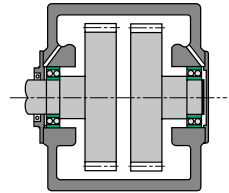

OIL MIST SYSTEM

One important advantage of this method of lubrication is that only a small quantity of oil is required, carried in a stream of compressed air. The oil mist equipment should be turned on before the machine is set in motion so as to ensure that the bearings are constantly covered by a thin film of oil when rotating.

Oil mist is advantageous for applications such as machine tools (where it can also be used to lubricate slideways, gears, chains and other components), since the air escaping from the bearing housing prevents the ingress of foreign matter. The flow of air also keeps the bearing cool. It is important that the compressed air used is absolutely clean and dry.

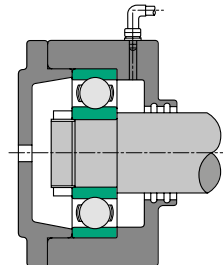

Lubrication

LUBRICATION INTERVAL

Casella di testo Casella di testo Forma The below table gives a estimation of the lubrication interval. Calculate the Kr value using the below formula and place it on the x axis. The crossing point with the upper green zone will indicate the maximum interval in hours . Then based on operating condition K1,K2,K3& K4 adjust the interval.

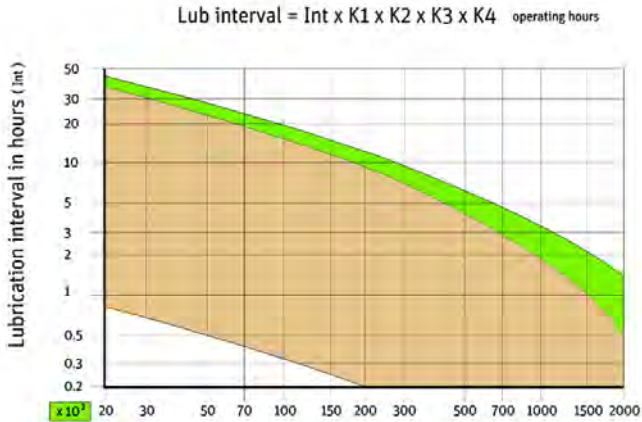

$$k_r \times n \times d_m \text{ (rpm} \times \text{mm)}$$

Type	DGB	ACB1	ACB2	SAB	TB	CRB1	CRB2	CRB FC	TRB	SRB	SRTB
Kr	1	1.5	1.9	1.3	5	1.75	1.9	23	3.5	6	12
Cleanliness & Moisture		LOW		HIGH		VERY HIGH					
		K1		0.9		0.65		0.4			
Shocks & Vibrations		LOW		HIGH		VERY HIGH					
		K2		0.9		0.65		0.4			
Operating temperature		< 70°		< >		> 90°					
		K3		0.9		0.65		0.4			
Loading		P/C		0.10		0.22		0.35			
		K4		0.9		0.65		0.4			

Typical: For Crushers: 1 x day – 1 x week For Oscillating movement: reduced interval

Example: DGB: Kr = 1 , dm = 120 mm, n = 1000 rpm => Int = 1 x 120 x 1000 = 120000 => 19000 h

Best condition: 0,9 x 0,9 x 0,9 x 0,9 = 0,650 x Int = 12350 h /Worse condition: 0,4 x 0,4 x 0,4 x 0,4 = 0,025 x Int = 475 h

Notes

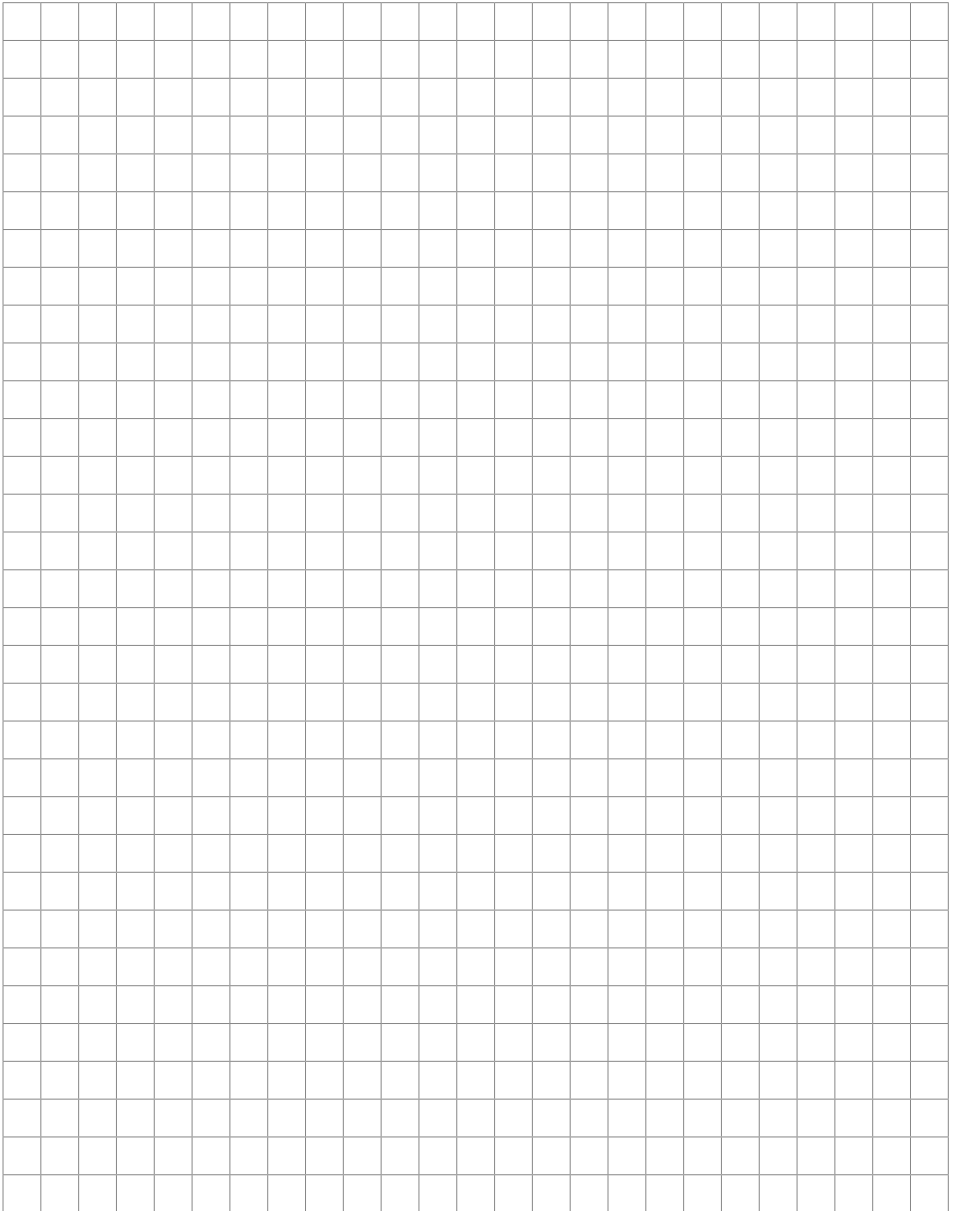

Standard terms and conditions of: Sale – Products & Services

REGAL BELOIT BELGIUM NV. T&C_EDITION 03/2015

1. DEFINITIONS:

In these Terms and Conditions of Sale, "Seller" means REGAL BELOIT BELGIUM nv, "Buyer" means the person, firm, company or corporation by whom the order is given.

2. THE CONTRACT:

2.1 All orders must be in writing and are accepted subject to these Terms and Conditions of Sale. No terms or conditions put forward by Buyer and no representations, warranties, guarantees or other statements not contained in Seller's quotation or Acknowledgement of Order nor otherwise expressly agreed in writing by Seller shall be binding on Seller.

2.2 The Contract shall become effective only upon the date of acceptance of Buyer's order on Seller's Acknowledgement of Order form or upon the date of fulfilment of all conditions precedent stipulated in the Contract, whichever is the later (the "Effective Date "). If the details of the Goods described in Seller's quotation differ from those set out in the Acknowledgement of Order Form the latter shall apply.

2.3 No alteration or variation to the Contract shall apply unless agreed in writing by both parties. However, Seller reserves the right to effect minor modifications and/or improvements to the Goods before delivery provided that the performance of the Goods is not adversely affected and that neither the Contract Price nor the delivery date is affected.

3. VALIDITY OF QUOTATION AND PRICES:

3.1 Unless previously withdrawn, Seller's quotation is open for acceptance within the period stated therein or, when no period is so stated, within thirty days after its date.

3.2 Prices are firm for delivery within the period stated in Seller's quotation and are exclusive of (a) Value Added Tax and (b) any similar and other taxes, duties, levies or other like charges arising outside Belgium in connection with the performance of the Contract.

3.3 Prices (a) are for Goods delivered EXW (Ex works) Seller's shipping point, exclusive of freight, insurance and handling unless otherwise stated in the Seller's order confirmation.

4. PAYMENT:

4.1 Payment shall be made: (a) in full without set-off, counterclaim or withholding of any kind (save where and to the extent that this cannot by law be excluded); and (b) in the currency of Seller's order confirmation within thirty days of date of invoice unless otherwise specified by Seller's Finance Department. Goods will be invoiced at any time after their readiness for dispatch has been notified to Buyer. Without prejudice to Seller's other rights, Seller reserves the right to: (i) charge interest on any overdue sums at 4% above the base lending rate of Fortis Bank, Brussels (or such higher rate stipulated by applicable law) during the period of delay; (ii) suspend performance of the Contract (including withholding shipment) in the event that Buyer fails or in Seller's reasonable opinion it appears that Buyer is likely to fail to make payment when due under the Contract or any other contract; and (iii) at any time require such reasonable security for payment as Seller may deem reasonable.

5. DELIVERY PERIOD:

5.1 Unless otherwise stated in Seller's order confirmation, all periods stated for delivery or completion run from the Effective Date and are to be treated as estimates only not involving any

contractual obligations.

5.2 If Seller is delayed in or prevented from performing any of its obligations under the Contract due to the acts or omissions of Buyer or its agents (including but not limited to failure to provide specifications and/or fully dimensioned working drawings and/or such other information as Seller reasonably requires to proceed expeditiously with its obligations under the Contract), the delivery/completion period and the Contract Price shall both be adjusted accordingly.

5.3 If delivery is delayed due to any act or omission of Buyer, or if having been notified that the Goods are ready for despatch, Buyer fails to take delivery or provide adequate shipping instructions, Seller shall be entitled to place the Goods into a suitable store at Buyer's expense. Upon placing the Goods into the store, delivery shall be deemed to be complete, risk in the Goods shall pass to Buyer and Buyer shall pay Seller accordingly.

6. FORCE MAJEURE:

6.1 Force Majeure of any kind, unforeseeable production, traffic or shipping disturbances, war, acts of terrorism, fire, floods, unforeseeable shortages of labor, utilities or raw materials and supplies, strikes, lockouts, acts of government, and any other hindrances beyond the control of the party obliged to perform which diminish, delay or prevent production, shipment, acceptance or use of the goods, or make it an unreasonable proposition, shall relieve the party from its obligation to supply or take delivery, as the case may be, as long as and to the extent that the hindrance prevails. If, as a result of the hindrance, supply and/or acceptance is delayed by more than eight weeks, either party shall have the right to cancel the contract. Should the Seller's suppliers fail to supply him in whole or in part, the Seller shall not be under obligation to purchase from other sources. In such cases, the Seller shall have the right to distribute the available quantities among his customers while at the same time taking into account his captive requirements.

7. DELIVERY, RISK & TITLE:

7.1 Unless otherwise expressly stated in the Contract, the Goods will be delivered Ex Works to the destination named in the Contract. Risk of loss of or damage to the Goods shall pass to Buyer upon delivery as aforesaid and Buyer shall be responsible for insurance of the Goods after risk has so passed. Delivery terms used in the Contract shall be defined in accordance with the latest version of Incoterms.

7.2 Title to the Goods shall pass to Buyer upon delivery in accordance with Clause 7.1.

7.3 Claims for shortfalls in quantity or for incorrect delivery shall be void if made more than 14 days after receipt by the customer.

8. DEFECTS AFTER DELIVERY:

8.1 Seller warrants (i) subject to the other provisions of the Contract, good title to and the unencumbered use of the Goods; (ii) that Goods manufactured by Seller and/or Seller's Affiliates shall conform with Seller's specifications therefore and be free of defects in materials and workmanship. Seller will make good by the supply of a replacement part or parts, any defects which, under proper use, care and maintenance, appear in Goods of Seller's Affiliates' manufacture and which are re-

ported to Seller within 12 calendar months after their delivery (the "Warranty Period") and which arise solely from faulty materials or workmanship: provided always that defective items are returned to Seller at Buyer's cost carriage and insurance prepaid within the Warranty Period. Repaired or replacement items will be delivered by Seller at Seller's cost to Buyer. Goods replaced in accordance with this Clause 10.1 shall be subject to the foregoing warranty for the unexpired portion of the Warranty Period or for ninety days from the date of their return to Buyer (or completion of correction in the case of Services), whichever expires the later.

8.2 Notwithstanding Clause 8.1, Seller shall not be liable for any defects caused by: fair wear and tear; materials or workmanship made, furnished or specified by Buyer; non-compliance with Seller's storage, installation, operation or environmental requirements; lack of proper maintenance; any modification or repair not previously authorised by Seller in writing. Seller's costs incurred in investigating and rectifying such defects shall be paid by Buyer upon demand. Buyer shall at all times remain solely responsible for the adequacy and accuracy of all information supplied by it.

8.3 Subject to Clause 10.1, the foregoing constitutes Seller's sole warranty and Buyer's exclusive remedy for breach thereof. No representations, warranties or conditions of any kind, express or implied, shall apply as to satisfactory quality, merchantability, fitness for any particular purpose or any other matter with respect to any of the Goods.

9. PATENT, ETC. INFRINGEMENT:

9.1 Subject to the limitations set forth in Clause 10, Seller shall indemnify Buyer in the event of any claim for infringement of Letters Patent, Registered Design, Design Right, Trade Mark or Copyright ("Intellectual Property Rights") existing at the date of formation of the Contract arising from the use or sale of the Goods, against all reasonable costs and damages awarded against Buyer in any action for such infringement, or for which Buyer may become liable in any such action, provided always that Seller shall not be liable to so indemnify Buyer in the event that:

- (i) such infringement arises as a result of Seller having followed a design or instruction furnished or given by Buyer, or the Goods having been used in a manner or for a purpose or in a country not specified by or disclosed to Seller prior to the date of the Contract or in association or combination with any other equipment or software, or
- (ii) Seller has at its expense procured for Buyer the right to continue to use the Goods or has modified or replaced the Goods so that the Goods no longer infringe.
- (iii) Buyer has failed to give Seller the earliest possible notice in writing of any claim made or to be made or of any action threatened or brought against Buyer and/or Buyer has failed to permit Seller, at Seller's expense, to conduct and control any litigation that may ensue and all negotiations for a settlement of the claim, or
- (iv) Buyer has made without Seller's prior written consent any admission which is or may be prejudicial to Seller in respect of any such claim or action, or
- (v) the Goods have been modified without Seller's prior written authorisation.

9.2 Buyer warrants that any design or instructions furnished or given by it shall not cause Seller to infringe any Intellectual Property Rights in the performance of Seller's obligations under the Contract and shall indemnify Seller against all reasonable costs

and damages which Seller may incur as a result of any breach of such warranty.

10. LIMITATION OF LIABILITY:

Supplier's maximum aggregate liability for any and all losses, liabilities, expenses (including legal expenses), damages, claims or actions incurred under or in connection with a specific order or a particular blanket order (CALL-OFF order) issued, arising in or by virtue of breach of contract, tort (including negligence), misrepresentation, breach of statutory duty, strict liability, infringement of intellectual property rights or otherwise, shall in no circumstances exceed a sum equal to the total price of the Call-Off in question.

11. STATUTORY AND OTHER REGULATIONS:

11.1 If Seller's obligations under the Contract shall be increased or reduced by reason of the making or amendment after the date of Seller's quotation of any law or any order, regulation or bye-law having the force of law that shall affect the performance of Seller's obligations under the Contract, the Contract Price and delivery period shall be adjusted accordingly and/or performance of the Contract suspended or terminated, as appropriate.

12. COMPLIANCE WITH LAWS

Buyer agrees that all applicable import, export control and sanctions laws, regulations, orders and requirements, as they may be amended from time to time, including without limitation those of the United States, the European Union and the jurisdictions in which Seller and Buyer are established or from which items may be supplied, and the requirements of any licences, authorisations, general licences or licence exceptions relating thereto will apply to its receipt and use of goods. In no event shall Buyer use, transfer, release, export or re-export any such goods in violation of such applicable laws, regulations, orders or requirements or the requirements of any licences, authorisations or licence exceptions relating thereto. Buyer agrees furthermore that it shall not engage in any activity that would expose the Seller to a risk of penalties under laws and regulations of any relevant jurisdiction prohibiting improper payments, including but not limited to bribes, to officials of any government or of any agency, instrumentality or political subdivision thereof, to political parties or political party officials or candidates for public office, or to any employee of any customer or supplier. Buyer agrees to comply with all appropriate legal, ethical and compliance requirements.

13. DEFAULT, INSOLVENCY AND CANCELLATION:

Seller shall be entitled, without prejudice to any other rights it may have, to cancel the Contract forthwith, wholly or partly, by notice in writing to Buyer, if (a) Buyer is in default of any of its obligations under the Contract and fails, within 30 (thirty) days of the date of Seller's notification in writing of the existence of the default, either to rectify such default if it is reasonably capable of being rectified within such period or, if the default is not reasonably capable of being rectified within such period, to take action to remedy the default or (b) on the occurrence of an Insolvency Event in relation to Buyer. "Insolvency Event" in relation to Buyer means any of the following: (i) a meeting of creditors of Buyer being held or an arrangement or composition with or for the benefit of its creditors being proposed by or in relation to Buyer; (ii) a chargeholder, receiver, administrative receiver or similar person taking possession of or being appointed over any



ROLLWAY®

Regal Beloit Belgium nv

Heiveldekens 16
2550 Kontich, Belgium
Call: +32 (0) 457 68 70
Fax: +32 (0) 457 51 38

Europe@regalbeloit.com

www.regalbeloit.com

APPLICATION CONSIDERATIONS

The proper selection and application of products and components, including the related area of product safety, is the responsibility of the customer. Operating and performance requirements and potential associated issues will vary appreciably depending upon the use and application of such products and components. The scope of the technical and application information included in this publication is necessarily limited. Unusual operating environments and conditions, lubrication requirements, loading supports, and other factors can materially affect the application and operating results of the products and components and the customer should carefully review its requirements. Any technical advice or review furnished by Regal Beloit America, Inc. and/or its affiliates ("Regal") with respect to the use of products and components is given in good faith and without charge, and Regal assumes no obligation or liability for the advice given, or results obtained, all such advice and review being given and accepted at customer's risk.

For a copy of our Standard Terms and Conditions of Sale, please visit <https://www.regalbeloit.com/Terms-and-Conditions-of-Sale>. These terms and conditions of sale, disclaimers and limitations of liability apply to any person who may buy, acquire or use a Regal product referred to herein, including any person who buys from a licensed distributor of these branded products.

Regal and Rollway are trademarks of Regal Beloit Corporation or one of its affiliated companies.

©2021 Regal Beloit Corporation, All Rights Reserved. MCC20020E • Form# 9728E

REGAL®

Standard terms and conditions of: Sale – Products & Services

REGAL BELOIT BELGIUM NV. T&C_EDITION 03/2015

distress, execution or other process being levied or enforced (and not being discharged within seven days) on the whole or a material part of the assets of Buyer; (iii) Buyer ceasing to carry on business or being unable to pay its debts; (iv) Buyer or its directors or the holder of a qualifying floating charge giving notice of their intention to appoint, or making an application to the court for the appointment of, an administrator; (v) a petition being presented (and not being discharged within 28 days) or a resolution being passed or an order being made for the administration or the winding-up, bankruptcy or dissolution of Buyer; or (vi) the happening in relation to Buyer of an event analogous to any of the above in any jurisdiction in which it is incorporated or resident or in which it carries on business or has assets. Seller shall be entitled to recover from Buyer or Buyer's representative all costs and damages incurred by Seller as a result of such cancellation, including a reasonable allowance for overheads and profit (including but not limited to loss of prospective profits and overheads).

14. MISCELLANEOUS:

14.1 No waiver by either party with respect to any breach or default or of any right or remedy and no course of dealing, shall be deemed to constitute a continuing waiver of any other breach or default or of any other right or remedy, unless such waiver be expressed in writing and signed by the party to be bound.

14.2 If any clause, sub-clause or other provision of the Contract is invalid under any statute or rule of law, such provision, to that extent only, shall be deemed to be omitted without affecting the validity of the remainder of the Contract.

14.3 Buyer shall not be entitled to assign its rights or obligations hereunder without the prior written consent of Seller.

14.4 Seller enters into the Contract as principal. Buyer agrees to look only to Seller for due performance of the Contract.

14.5 GOODS PROVIDED HEREUNDER ARE NOT SOLD OR INTENDED FOR USE IN ANY NUCLEAR OR NUCLEAR RELATED APPLICATIONS. Buyer (i) accepts Goods in accordance with the foregoing restriction, (ii) agrees to communicate such restriction in writing to any and all subsequent purchasers or users and (iii) agrees to defend, indemnify and hold harmless Seller from any and all claims, losses, liabilities, suits, judgements and damages, including incidental and consequential damages, arising from use of Goods in any nuclear or nuclear related applications, whether the cause of action be based in tort, contract or otherwise, including allegations that the Seller's liability is based on negligence or strict liability.

14.6 The Contract shall in all respects be construed in accordance with the laws of Belgium excluding, however, any effect on such laws of the 1980 Vienna Convention on Contracts for the International Sale of Goods and to the fullest extent permitted by law, shall be without regard to any conflict of laws or rules which might apply the laws of any other jurisdiction. All disputes arising out of the Contract shall be subject to the exclusive jurisdiction of the Belgium courts.

14.7 The headings to the Clauses and paragraphs of the Contract are for guidance only and shall not affect the interpretation thereof.

14.8 All notices and claims in connection with the Contract must be in writing.

This are the sales conditions we are sending with each quote & sales.

For the latest T&C version, surf to:

www.regalbeloit.com/brands/Rollway/Terms-Sales